



Enterprise Architect

User Guide Series

Modeling Fundamentals

Author: Sparx Systems

Date: 16/10/2024

Version: 17.0

CREATED WITH  ENTERPRISE
ARCHITECT

Table of Contents

Modeling Fundamentals	23
Models	29
Model Perspectives	31
Types of Perspective	40
Using Perspectives	56
Customizing Perspectives	61
Perspectives for Security Groups	72
Perspective Modeling	80
The Model Builder	86
Customize Model Content	93
Model Views	96
Add Views	99
Rename Views	101
Delete Views	103
Model Packages	105
Add a Package	107
Open Package in the Browser Window	111
Rename a Package	112
Copy a Package	114
Delete a Package	117
Model Diagrams	118
Diagram View	121
Working In Diagrams	127
Add New Diagrams	132

Insert Diagram Properties Note	135
Drop Package From Browser Window	137
Show or Hide Package Contents	141
Drop Elements from Browser Window	143
Drop Elements onto Connectors	151
Drop Elements onto Other Elements	154
Z Order Elements	156
Move Elements Within Diagrams	158
Move Elements In Diagram Sections	169
Move Elements Between Diagrams	171
Copy Elements Between Diagrams	173
Move/Copy Elements To & From Floating Diagrams	177
Autosize Elements	180
Annotations	182
Virtual Connector Ends - Represent One Element Several Times on a Diagram	184
Locate Related Elements	189
Manage Object Labels	191
Hide/Show Labels	195
Show Realized Interfaces of Class	197
Open Package From Diagram	199
Undo Last Action	200
Redo Last Action	201
Add Diagram Links to Diagrams	202
Hyperlinks Between Diagrams	207
Pan and Zoom a Diagram	209

Diagram Navigation Hotkeys	211
View Previous and Next Diagram	214
Change Diagram Type	215
Grid-Style Diagrams	217
Scriptlets	222
Entry points and Multiple Scriptlets	227
Using Scriptlets in MDG Technologies	230
Scale Image to Page Size	232
Set Up Diagram Page	234
Lock Diagram	237
Copy (Duplicate) or Move Diagram	238
Save Diagram Image to File	242
Copy Image to Clipboard	245
Delete Diagrams	247
Diagram Tabs	249
Switch Between Views	254
Diagram Toolbox	257
Toolbox Appearance Options	268
Toolbox Shortcut Menu	275
Add Multiple Elements	278
Common Pages	284
Artifact Toolbox Pages	289
Documents Toolbox	290
Governance Toolbox	296
Charts Toolbox	301
Dynamic Viewpoints Toolbox	305
Simulation Toolbox	309

Use Case Toolbox	312
Class Toolbox	314
Object Toolbox	316
Composite Toolbox	318
Communication Toolbox	320
Interaction Toolbox	322
Timing Toolbox	324
State Toolbox	326
Activity Toolbox	328
Component Toolbox	330
Deployment Toolbox	332
Profile Toolbox	334
Metamodel Toolbox	338
Analysis Toolbox	340
Custom Toolbox	342
Requirements Toolbox	345
Maintenance Toolbox	348
User Interface Toolbox	351
WSDL Toolbox	354
XML Schema Toolbox	356
Data Modeling Toolbox	358
Test Domain Toolbox	361
XML Transformation Toolbox	363
Diagram Properties	365
Diagram Properties - General	367
Diagram Properties - Detail	373
Diagram Properties - Elements	381

Diagram Properties - Features	389
Diagram Properties - Connectors	393
Diagram Properties - Theme	397
The Quick Linker	401
Create Connectors	406
Create New Elements	408
The Context Buttons	410
The Context Menu	418
Diagram Layers	428
Diagram Filters	434
Work With Diagram Filters	440
Context Filter a Diagram	449
Diagram Legends	451
Create Legends	454
Legend Properties	457
Legend Key	460
Navigation Cells	470
Swimlanes	476
Creating Sub-lanes	484
Swimlane Details	487
Swimlanes Matrix	489
Diagram Relation Matrix	496
Roadmap Diagrams	507
Roadmap Diagram Options	517
Custom Diagram Styles	528
The Pan & Zoom Window	543
Auto Refresh	546

Layout Diagrams	549
Circular/Elliptical Layout	553
Box Layout	558
Per Page Layout	561
Digraph Layout	564
Spring Layout	565
Neaten Layout	567
Converge/Diverge Layout	570
Fan Relations Layout	572
Auto Route Layout	575
Lay Out a Diagram Automatically	577
Chain Diagram Layouts	585
Image Assets	589
Using the Image Manager	594
Create Custom Diagram Background	601
Import Image Library	603
Diagram List	606
Alternative Views of Diagram Content	611
User and Model Default Diagrams	615
Print Diagram	618
Print Preview	619
Model Elements	621
Element Facilities	623
Create Elements	628
Add Elements Directly To Packages	630
Auto Names and Counters	635
Apply Auto Naming to Existing Elements	641

Set Up Templates Package	647
Set Element Font	654
Move Elements Between Packages	658
Copy Elements	662
Copy Features Between Elements	665
Highlight Context Element	667
Move Features Between Elements	669
Insert Related Elements	671
Change Element Type	676
Make Linked Element a Local Copy	678
Set an Element's Default Appearance	679
Feature Visibility	684
Align Elements	691
Resize Elements	695
Element Grouping	698
Create Notes and Text	700
Link Note to Internal Documentation	703
Delete Elements from Diagram and Model	708
Customize Visibility of Elements	712
Set Up Cross References	714
Show Element Use	717
Manage Structural Elements	723
Template Classes	729
Set Element Parent	731
Composite Elements	735
Show Structural Elements In Composite Diagram	742
Visual Representation	745

Compartments	746
Rectangle Notation	748
Info View Style	750
Element Property Displays	754
Properties Dialog	756
General Settings	760
Details	766
Advanced Properties	770
Links	772
The Features Window	775
Responsibilities	777
Requirements	783
External Requirements	788
Constraints	789
Scenarios	793
Scenarios - Responsibility Window	795
Scenarios - Properties Dialog	798
Scenarios View	802
Scenarios View Toolbar	805
Scenarios View Item Context Menu	810
Scenarios View Selected Text Context Menu	815
Scenarios View Entry Points Context Menu	821
Scenarios View Floating Toolbar	824
Import a Scenario File	825
Set Up Scenario Specification	827
Generate Diagrams	833
Generate Activity Diagram	837

Generate RuleFlow Diagram	842
Generate StateMachine Diagram	844
Generate Sequence Diagram	847
Generate Robustness Diagram	852
Generate Scenario From Activity Diagram	855
Generate Test Cases	858
Scenarios View - Context References	864
Scenarios View - Constraints	867
Associated Files	869
Dynamic Preview View	872
Select <Item> Dialog	883
Select Property Dialog	887
Set Feature Dialog	890
Element Context Menu Operations	892
Selectable, Dockable and Printable Options	902
Advanced Operations on Elements	905
Finding Elements	912
Changing Element Appearance	915
Operations on Multiple Elements	920
Linked Documents	927
Create Document Artifact	932
Create Linked Document on an Element	934
Edit Linked Documents	938
Linked Documents in the Document Window	942
Replace or Delete Linked Documents	948
Create Linked Document Templates	950
Edit Linked Document Templates	953

Hyperlink From Linked Document	956
Create Element From Document	963
Connectors	965
Connector Management Options	973
Connector Type-Specific Options	975
Manage Connector Properties	978
Advanced Connector Management Options	979
Connector Style Options	982
Connector Appearance Options	989
Connector Tasks	992
Connect Elements	994
Connect to Element Feature	997
Feature Quick Linker	1000
The Feature Matrix	1002
Connect to a Connector	1012
Add a Note to a Connector	1016
Arrange Connectors	1018
Change Connector Type	1020
Change the Source or Target Element	1021
Connector Styles	1023
Create Connector in Browser Window	1030
Relationship Visibility	1032
Freeze Visible Connectors	1034
Hide/Show Connectors	1037
Delete Connectors	1040
Creating Generalization Sets	1042
Connector In-place Editing Options	1045

Reverse Connector	1046
Set Association Specializations	1047
Change Sequence Message Scope	1049
Show Uses Arrow Head	1051
Tree Style Hierarchy	1052
Tagged Values	1055
Quick Start - Add Tagged Value To Elements	1059
Assign a Tagged Value to an Item	1061
Assign Notes to a Tagged Value	1063
Modify Tagged Values	1065
Show Duplicate Tags	1068
Advanced Tag Management	1070
Attributes	1072
Create and Manage Attributes	1077
Attribute Tagged Values	1084
Display Inherited Attributes	1086
Create Object From Attribute	1089
Classifiers and Instances	1091
Classify an Object	1093
Add Property Slots to Instance	1096
Classify Object Via Classifier Associations	1098
Behavior	1102
Operations	1103
Define Properties of Operations	1106
Operation Behavior	1112
Behavior Code	1118
Redefine Operation and Check for Exceptions	1121

Operation Constraints	1125
Operation Tagged Values	1128
Override Parent Operations	1131
Display Inherited Operations	1134
Behavior Parameters	1136
Define Parameters	1137
Parameter Tagged Values	1142
Operation Parameters by Reference	1145
Interactions and Activities	1147
Behavior Calls	1149
Associate with Different Behaviors	1151
Behavior Call Arguments	1152
Synchronize Arguments	1155
Hyperlinks	1157
Hyperlink Target Objects	1167
In-place Editing Options	1178
In-place Editing Tasks	1179
Edit Element Item Name	1184
Edit Feature Stereotype	1186
Edit Feature Scope	1189
Edit Attribute Keyword	1191
Edit Operation Parameter Keyword	1193
Edit Parameter Kind	1195
Edit Custom Compartment	1197
Insert New Feature	1199
Insert Operation Parameter	1201
Insert Maintenance Feature	1203

Insert Project Features	1206
Insert Testing Features	1209
Non-printable Elements	1212
Manage Model Change	1215
Timelines Window	1220
The Diagram Tab	1221
The Package Tab	1228
The Element Tab	1234
The TAM Tab	1237
The Version Control Tab	1240
The Auditing Tab	1246
Tracking Change	1248
Baselines	1250
Brief Introduction	1252
Creating Baselines	1256
Compare a Model to Baselines	1259
The Compare Utility (Diff)	1261
Compare Options	1264
Example Comparison	1267
Compare Utility View Options	1270
Visual Diagram Changes	1276
Revert Model to a Baseline	1284
Manage Baselines	1286
Manage Baselines in Model	1288
Manage Baselines in Reusable Asset Service	1292
Baseline Contents	1298
Baseline Dependencies	1301

Add Review Comments.....	1305
More Information.....	1307
Reuseable Asset Service (RAS).....	1311
Set Up the Asset Service.....	1315
Set Up Registry Password.....	1319
Creating Asset Storages.....	1322
Copying Asset Storages.....	1328
Change Storage Details.....	1331
Delete a Storage.....	1335
Connect to the Asset Service.....	1337
Browse Assets.....	1341
Asset Properties.....	1345
Package Contents.....	1348
Package Dependencies.....	1351
Package Technologies.....	1354
Storage Files.....	1358
Add Review Comments.....	1360
Compare an Asset to the Model.....	1362
Register Assets.....	1364
Register Packages and Files as Assets.....	1367
Register Learning Center Library.....	1373
Register Reference Data Library.....	1375
Register Source Code Library.....	1377
Check Package Dependencies.....	1379
Update an Asset.....	1384
Import an Asset into the Model.....	1390
Search Registry.....	1395

Auditing	1398
Brief Introduction	1400
Audit Settings	1407
View the Audits	1414
Audit View	1415
Audit View Controls	1420
System Output - Audit History	1425
Performance Considerations	1427
Auditing Performance	1429
Audit View Performance	1431
More Information	1433
Version Control	1435
Brief Introduction	1437
Setup Options	1445
Version Control Locking Overview	1446
Repository Options	1448
Version Control of Model Data	1453
Version Control Nested Packages	1455
Version Control and Reference Data	1457
Version Control and Teams	1458
Offline Version Control	1461
Version Control Branching	1467
Version Control Product Setup	1468
System Requirements	1471
Create a Subversion Environment	1475
Create a new Repository Sub-tree	1479
Create a Local Working Copy	1481

Verify the SVN Workspace.....	1484
Subversion Under Wine-Crossover.....	1486
Preparing a Subversion Environment Under Wine.....	1488
TortoiseSVN.....	1492
Create a TFS Environment.....	1493
TFS Workspaces.....	1498
TFS Exclusive Check Outs.....	1502
Verify the TFS Workspace.....	1504
Create a CVS Environment.....	1506
Prepare a CVS Local Workspace.....	1510
Verify the CVS Workspace.....	1513
TortoiseCVS.....	1515
Create an SCC Environment.....	1516
Upgrade at Enterprise Architect Version 4.5, Under SCC Version Control.....	1519
Version Control Configuration.....	1521
Version Control Settings.....	1524
SCC Settings.....	1529
CVS Settings.....	1533
SVN Settings.....	1536
TFS Settings.....	1539
Re-use an Existing Configuration.....	1544
Applying to Packages.....	1546
Configure Controlled Package.....	1547
Browser Window Indicators.....	1551
Apply Version Control To Branches.....	1553

Fundamental Usage	1555
Package Version Control Options	1558
Check Out a Package	1567
Undo Check Out of a Package	1569
Check In a Package	1570
Check Out a Model Branch	1572
Check In a Model Branch	1574
Update to the Latest Revision of Selected Package	1577
Update to the Latest Revision of All Packages	1580
Review Package History	1583
Review Package History - SCC Client	1586
Retrieve Prior Revision - SCC Client	1589
Advanced Usage	1592
Include Other Users' Packages	1594
Export Controlled Model Branch	1596
Import Controlled Model Branch	1598
Manually Locating Model Branch Files	1601
Add Connectors To Locked Elements	1604
Validate Package Configurations	1606
Resynchronize the Status of Version Controlled Packages	1608
Performance Considerations	1611
More Information	1615
Compare Projects	1617
Time Aware Models	1621
Clone Structure as New Version	1625
Clone Diagram as New Version	1629

Clone Element as New Version	1634
Traceability	1639
The Specification Manager	1646
Specification Manager - Overview	1649
Specification - Specify Ribbon	1655
Using the Specification Manager	1657
Specification Manager Configuration	1665
Appearance Options	1666
Model Options	1670
Package Options	1674
Select Specification Type	1678
Select Specification Package	1680
Customize Columns	1686
Adding Elements	1691
Deleting Elements	1696
Editing Elements	1698
Indicator Columns	1705
Traceability	1708
Open Relationship Matrix	1710
Create Matrix Profile	1713
Reviewing Elements	1717
Create Review Document	1721
View Review Document	1727
Managing Changes	1729
Reporting	1735
The Data Miner	1740
Data Miner Toolbox	1743

Data Sources	1746
Data Miner Set	1752
Data Miner Visualizer	1754
Data Miner Scripts	1756
Model Validation	1759
Configure Model Validation	1763
Run Validation	1764
Rules Reference	1766
Well-Formedness	1770
Element Composition	1773
Property Validity	1775
OCL Conformance	1777
Model Options	1781
Baseline Page	1787
Cloud Page	1794
Translate Page	1800
Collaboration Page	1804
Review Status Locks Page	1806
Model Glossary	1808
Project Glossary View	1812
The Glossary Dialog	1818
Create a Glossary as a Package Structure	1823
Create a Translation Glossary Model	1834
Glossary Styles	1839
Generate a Report	1844
Glossary Report Output Sample	1846
Translation Facilities	1848

Model Transformation	1854
Transform Elements	1860
Chaining Transformations	1864
Built-in Transformations	1865
C# Transformation	1868
C++ Transformation	1870
Data Model To ERD Transformation	1872
DDL Transformation	1874
EJB Transformations	1880
ERD To Data Model Transformation	1883
Java Transformation	1887
JUnit Transformation	1890
NUnit Transformation	1893
PHP Transformation	1896
Sequence/Communication Diagram Transformations	1897
VB.Net Transformation	1900
WSDL Transformation	1901
XSD Transformation	1903
Edit Transformation Templates	1908
Write Transformations	1914
Default Transformation Templates	1918
Intermediary Language	1920
Intermediary Language Debugging	1922
Objects	1925
Connectors	1935
Transform Connectors	1940

Transform Foreign Keys	1944
Copy Information	1946
Convert Types	1948
Convert Names	1949
Cross References	1952
Transform Template Parameter Substitution	1955
Bookmarks	1960
Standard Bookmarks	1962
Annotated Bookmarks	1965



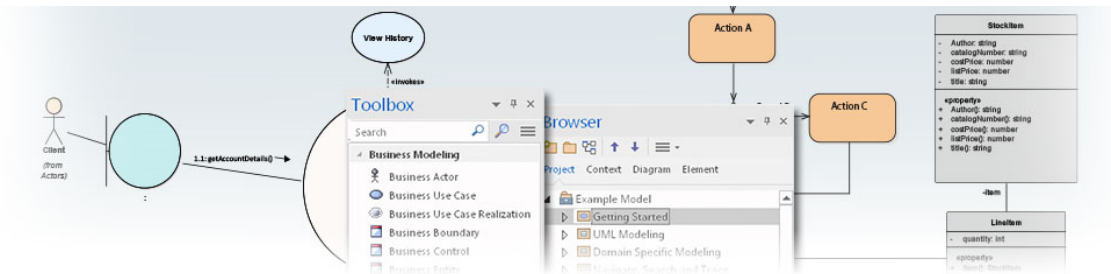



Modeling Fundamentals







Modeling is the practice of constructing a graphical representation of something real for the purpose of studying, documenting, reasoning, testing or communicating it to others. The resulting models can be compared to machines that do work and often provide deep insights into the way things in the real world are structured or behave. Enterprise Architect is typically used to model complex enterprise, business, engineering, real-time and software systems, and is a multi-disciplinary platform that facilitates teams of people working together to describe, visualize, construct and test complex systems through the use of modeling. Enterprise Architect's modeling platform is based on the Unified Modeling Language (UML), a standard that defines rules and notation for software-centric systems but that can be extended to allow any type of system to be modeled.

Modeling Features

Feature	Description
Models	Models are the top level of an Enterprise Architect Project. A Project can have one

	<p>or many models contained within it.</p>
<p>Views</p> 	<p>Views provide unique windows and dialogs to explore the relationships of the elements in your model.</p>
<p>Packages</p> 	<p>Packages are the containers for your elements and your diagrams. Their contents can be viewed in many different ways dependant on your needs.</p>
<p>Diagrams</p> 	<p>Diagrams are used to define specific relationships between a select number of elements in a visual manner.</p>
<p>Elements</p> 	<p>Elements are the building blocks of your model; create and reuse elements to build up your systems.</p>
<p>Connectors</p> 	<p>Connectors define the relationships between modeled elements.</p>
<p>Tagged Values</p> 	<p>Extend the default properties of modeled elements, connectors and features with custom properties called Tags that can be given values.</p>
	<p>Provide a text-based description of</p>

<p>Notes</p> 	<p>modeled: elements, connectors features, diagrams and more. Notes can be shown on the diagram, in the element or from the Notes View.</p>
<p>Hyperlinks</p> 	<p>Hyperlinks add an incredible versatility to both navigation of your model and the provision of information through the various methods of communication within your project. In developing your model, you inevitably have to store information and structures in different places for different purposes and in different formats. Creating hyperlinks helps you to draw separate objects and documents together wherever appropriate to define or support a given context.</p>
<p>Templates and Wizards</p> 	<p>Use patterns, templates and wizards to rapidly build your models. Use pre-existing ones, or create your own!</p>
<p>Automation</p> 	<p>Extend the power of Enterprise Architect to create your own domain-specific Add-Ins, scripts and functionality.</p>

Structural Components

Using Enterprise Architect, you can quickly build a model using a hierarchy of Packages to represent the structure and organization of the model.

Component	Description
Models	<p>A model is the highest conceptual level, representing a distinct and complete representation of all or some part of a modeled system.</p> <p>A Project can contain multiple models.</p>
Views	<p>Views are the second level within a model and define a specific viewpoint of the system being modeled - for example a Use Case view, a Requirements View or a Dynamic (behavioral) View.</p> <p>Views are simply Packages that have an additional conceptual meaning.</p>
Packages	<p>The basic containers that create the overall model structure. Packages hold other Packages, elements, diagrams and similar model constructs.</p>
Diagrams	<p>Diagrams are visual representations of how model elements are connected or behaviorally related. They can also display the characteristics of an element,</p>

	such as attributes, methods, notes and Tagged Values in a convenient visual style.
Elements	Elements are the basic building blocks of models. They represent both structural constructs such as Classes and Interfaces, as well as behavioral constructs such as Activities, Actions and States.
Connectors	Connectors represent the various kinds of relationship between elements within a model - including behavioral relationships, associations, taxonomic relations and similar.
Tagged Values	Tagged Values are customizable, profile- or user-defined properties that are generally related to a Stereotype and define additional attributes and characteristics of an element. They are one of the fundamental means of extending UML into more domain-specific areas.
Notes	Notes are the standard common language-based descriptions of what an element, diagram, feature or relationship is for and how it is used within the model.

	Notes are often used as a first step to eliciting the meaning and use of an element - which is later refined into something more concrete and precisely specified.
Reference Information	A variety of basic types of information that is used across a particular model - for example, Stereotypes or Tagged Values.

Models



An Enterprise Architect model is a top level (root) Package in a repository. It is possible to have more than one root Package in a repository and hence more than one model. Each model is the root node of a hierarchy of Packages, elements, features and diagrams that are nested under the Package. The Browser window is used to manage the model and the hierarchy of elements, features and diagrams, showing how the models are structured and helping you to reorganize a model by dragging and dropping objects to new locations in the hierarchy.

Enterprise Architect has a handy Model Builder that helps you to create models and a hierarchy of Packages under each root, from a wide selection of model Patterns. Using the Model Builder simplifies the process of setting up repositories and models for the novice modeler. More experienced modelers are free to add a single Model Package and build up the structure as they see fit, or to create a model from a base (template) repository.

As your model develops, you can use the Model Builder to inject fine-grained content into your overall model structure. A Package configured to manage Requirements, or one for Decision modeling, or Simulation of States or one of hundreds of other pre-built patterns that help you develop

and refine your model for your domain and your project.
As the repository is developed and during the lifetime of a project or program of work, new models might have to be added and existing ones refactored.

Model Perspectives

Enterprise Architect is used by a wide range of teams, from executives and Business Architects who model organizational change and strategic direction at the highest level, through to Technology Architects who model infrastructure and implementation at the lowest level, with a large number of other disciplines in between. These additional disciplines include Business Analysts, Process Analysts and Requirement Analysts; Information Architects, Data Architects, Application Architects and Security Architects; System Engineers and Product Engineers; Testers; Scrum Masters and many more.

Enterprise Architect has a huge range of available features supporting these disciplines that, when seen together, might be difficult to assess. To ensure a modeler can quickly identify and use the features of greatest value to the role they are performing at a particular time, Perspectives have been created to bundle the features - including modeling languages and example patterns - into sets. This allows you to effectively change roles and focus simply by switching to another Perspective - almost like putting on a different hat. When a Perspective is selected the tool instantly changes to hide the irrelevant features and only display the ones defined for that Perspective. Some modelers might select or be assigned a single Perspective for the lifetime of a role or project, whilst others might switch Perspectives five or six times a day.

The Perspectives are completely configurable, allowing fine

grain inclusion (and thus exclusion) of language constructs and tool features; this can be done at a whole-model level, security group level or personal level.

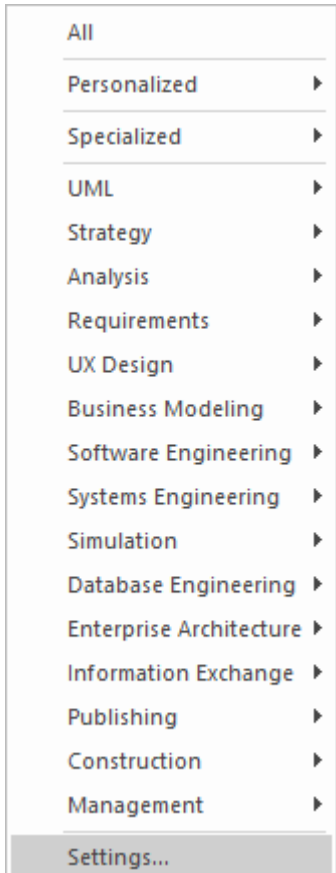

Perspectives:

- Are selections of Technologies - some specific to one of the many modeling languages - and their model and diagram Patterns
- Are tailored to domain-specific modeling scenarios; when you work in a specific domain, you can apply a Perspective to expose appropriate facilities and hide all others
- Remove the significant distraction of having to identify and assess multiple technologies before proceeding with your work

- Help you to select and apply an environment of particular modeling languages or Technologies, enabling you to work effectively and efficiently on the task at hand
- Help you to switch easily and quickly between tools when your modeling focus changes; you simply select another Perspective from the list of Perspective Sets (which identify the domain they support) and Enterprise Architect then hides the features of the previous Technologies and applies the new environment

Initially you can select from the built-in Perspective Sets and the more than eighty Perspectives they provide. As your experience in modeling with Enterprise Architect develops and your work becomes more specific, you can create custom Perspectives either just for yourself or for all users of the model. This helps you work within a Technology that you might have recently imported and activated, or apply a combination of Technologies that are not associated in the built-in sets.

Overview

You select and switch to the required Perspective through:

- The  <perspective name> option at the top right of the screen (which identifies the currently-active Perspective), or
- Through the 'Start > All Windows > Perspective' drop-downs in the ribbon, or
- Directly through the Perspective Portal in the Portals window

Selecting a built-in Perspective automatically brings up the Model Builder dialog with the Model Builder tab selected, which provides a rich set of new model patterns and guidance notes, filtered to narrow down the available patterns, technologies, diagram types and other modeling constructs to the precise set required, with similar actions on the Diagram Toolbox pages and dialogs. This helps you to quickly build accurate, focused models with minimal 'noise' and maximum fidelity.

Applying a Perspective mainly takes place through the Model Builder dialog, Diagram Toolbox and 'Stereotypes' dialog, for creating model structures. Note that the  <perspective name> option sets the global Perspective for the model and in these dialogs and displays, but the windows, dialogs and ribbons allow you to swap to a different Perspective for a work task instantly, making it easy to find and change to the exact modeling tools required at that moment.

As a huge boost to modeling encompassing several disciplines and modeling domains, selecting a Perspective provides its Technology as an available development tool, whilst all existing model structures that make use of the *hidden* Technologies still render and work as normal. If you have a model that contains, say, a BPMN View and a SysML View, you might apply a Perspective to support the creation of BPMN structures and see only BPMN templates and Toolbox items in your BPMN development. But if you open a SysML diagram during this work, you will still see the SysML Toolbox pages, Properties pages and options that

enable you to properly examine that diagram.

To further enhance your modeling experience, you can also use the Perspective Sets dialog to filter the Perspectives, hiding complete Perspective sets or individual Perspectives. This enables you to reduce the list of Perspectives offered for selection to just those you are likely to use.

Additionally, the model administrator can tailor the Perspectives and/or ribbons available to each User Security Group, as a Perspective Setting or Ribbon Set for each group. This filters the Perspectives available to a user according to their security group, rather than their personal choice. See the *Perspectives for Security Groups* Help topic. Regardless of which Perspective you select, all of the coding languages, templates, RTF templates and images remain immediately available.

For specific instructions on using Perspectives, see the *Using Perspectives* Help topic.

System Perspectives

Enterprise Architect provides a rich set of more than eighty Perspectives built directly into the application, which have been crafted to align with the multitude of roles that modelers perform; these Perspectives are grouped into Sets that make finding the right Perspective quick and easy, and include:

- Business Sets for Strategy, BPMN, Business Analysis and more, helping the business user focus on their current task

- SysML, MBSE, Software, Simulation and others, for the Systems Engineer and Software Engineer
- ArchiMate, TOGAF, Zachman Framework and GRA-UML, version-specific Sets that provide the most common tools for the needs of Enterprise Architects
- SPEM, Process Guidance and MDG Technology Builder for Project Managers

Each set contains a number of relevant and useful Perspectives. This image shows an example of the Analysis Perspective Set, which contains a number of Perspectives.

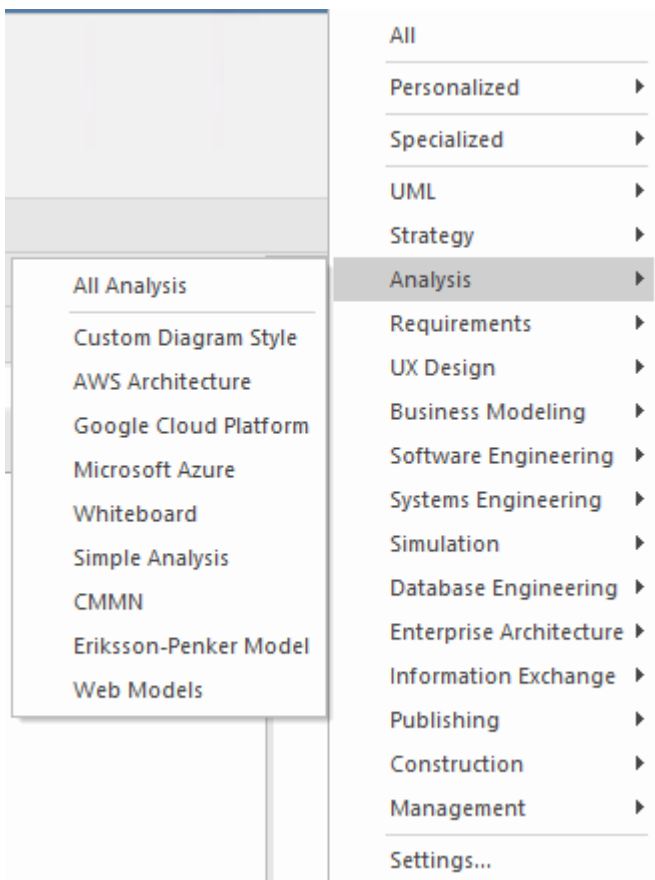

For a more comprehensive description of the built-in Perspectives, see the *Types of Perspective* Help topic.

Custom Perspectives

In addition to the built-in Perspectives, you can create any number of your own Perspectives on the 'Personal Sets' tab of the Perspective Sets dialog. While the built-in, or system, Perspectives typically contain a single language or technology - for example the Business Process Model and Notation (BPMN) Perspective allows you to focus on just BPMN - custom Perspectives allow you to open a number of technologies at the same time. For example, if you regularly create prototypes you might want to create a 'Prototyping' Perspective that groups the technologies and modeling languages you use in that work.

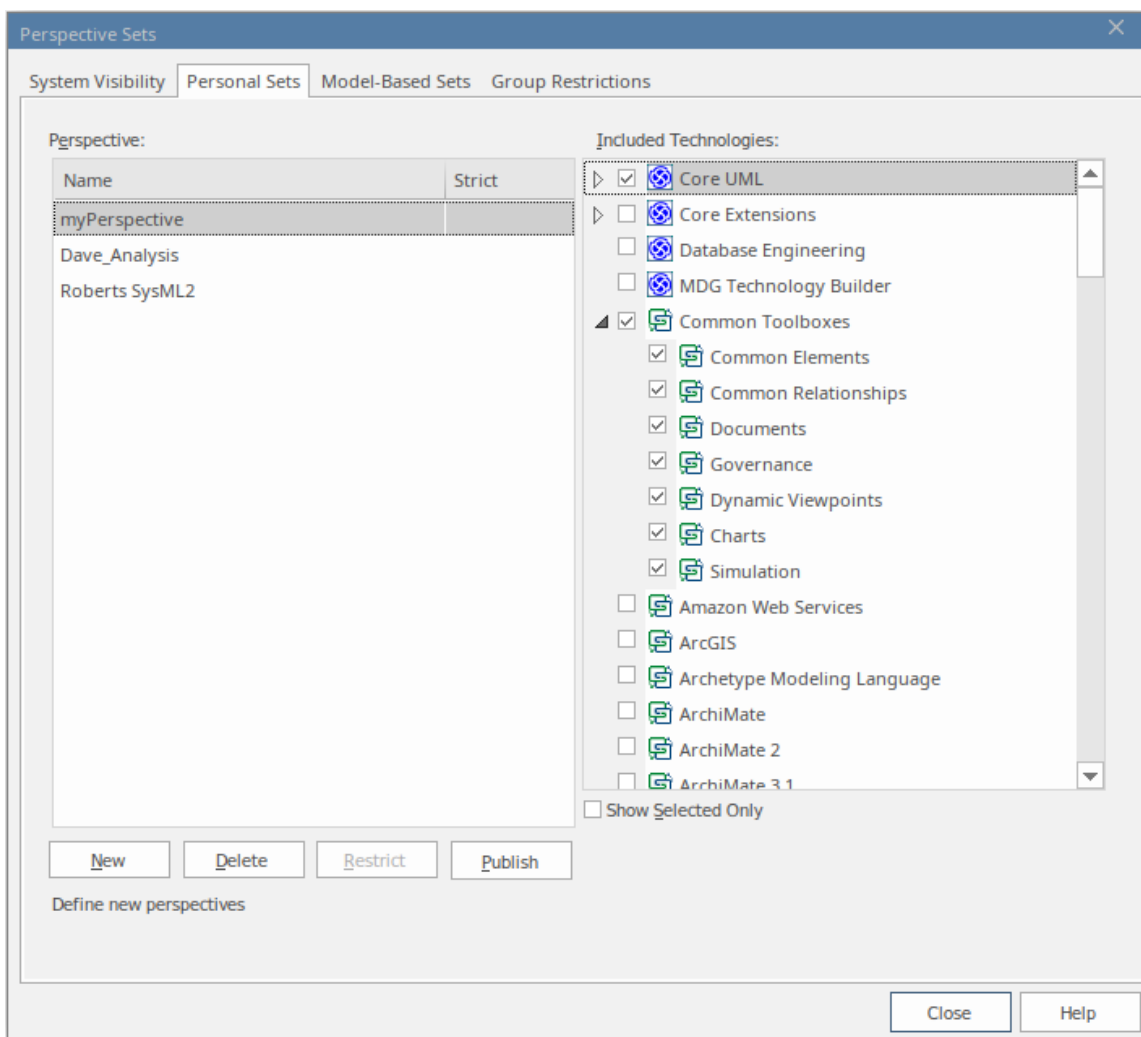

These custom Perspectives can be created, modified and

deleted as the roles you perform change over time. For information on creating custom Perspectives, see the *Customizing Perspectives* Help topic.

Perspective Modeling

Built-in perspectives can be modeled using the MDG Technology for Model Perspectives. This can be accessed by selecting the perspective **Custom Technologies > Model Perspectives**. On a perspective workspace diagram, one or more perspectives are modeled as having a number of technology sets, each of which is made up of a number of technologies. A perspective can be linked to a security group. When a security group has a perspective linked to it, that perspective will be the only one that members of the security group can access, so security groups can be linked to multiple perspectives, including built-in (internal) perspectives.

Ribbon sets can also be defined on a perspective workspace diagram. A ribbon set defines which ribbon commands are available and will have a number of linked ribbon categories, named for the main ribbons - Design, Layout, Develop etc. Each ribbon category will have a number of ribbon groups, named for the panels on a ribbon, e.g. ribbon category 'Design' will have ribbon groups Explore, Package, Diagram etc. When a ribbon set is linked to a security group, it defines and limits the ribbon commands available to members of the security group.

For more information, see the Perspective Modeling help

topic.

Types of Perspective

There is a wide selection of built-in Perspectives provided within Enterprise Architect, each containing a suite of Patterns. The Perspectives themselves are organized into groups called Perspective Sets.

Extensive research has been conducted to define sets of Perspectives that are expertly tailored to meet the needs of modelers who work in a particular project discipline or team role. For example, there are Perspectives for strategists, enterprise and solution architects, requirement analysts, user experience designers, informaticians, systems engineers and many more, remembering that a user can switch to another available Perspective at any time when their role or modeling emphasis changes. You can select certain sets and hide others; effectively, it is like having access to fifty different tools, but all cleverly concealed when they are not required, allowing you to stay focused on the task at hand with the tools, workspaces, languages and features that are needed, including best practice patterns to get your modeling off to a flying start.

This *Types of Perspective* topic is a reference, describing each Perspective Set and Perspective. You can also create your own Personal Perspectives, which are included under the second item in the full list of Perspective Sets.

To select and apply any of these Perspectives, see the [Using Perspectives](#) Help topic.

Perspectives

Category	Perspectives
All	This category lists every Perspective Set and Perspective available.
Personal Sets	This category lists every custom Perspective that is available to you.
Shared Sets	The 'Shared Sets' category holds the Perspectives that you have created for yourself, using the 'Start > All Windows > Perspective > Settings' option. For further details, see the Help topic <i>Customizing Perspectives</i> .
Specialized	This category lists all Perspectives provided by imported User Technologies (including the UML Technology).
UML	The UML category provides the Perspectives for normal UML modeling, including: <ul style="list-style-type: none">• All UML Modeling - all modeling tools and objects provided by the other Perspectives in this group• UML Structural Models - the modeling tools and objects for structural UML models, such as:

	<ul style="list-style-type: none"> - Package diagrams - Class diagrams - Object diagrams - Composite Structure diagrams - Component diagrams - Deployment diagrams • UML Behavioral Models - the modeling tools and objects for behavioral UML models, such as: <ul style="list-style-type: none"> - Use Case diagrams - Sequence diagrams - Communication diagrams - Timing diagrams - Interaction Overview diagrams - Activity diagrams - StateMachine diagrams
Strategy	<p>The Strategy category provides Perspectives for:</p> <ul style="list-style-type: none"> • All Strategy - all modeling tools and objects provided by the other Perspectives in this group • Mind Mapping - the basic Mind Map diagram • Strategy modeling, such as: <ul style="list-style-type: none"> - Organizational Chart - Value Chains - Strategy Maps - Balanced Scorecard

	<ul style="list-style-type: none"> - One-level and Two-level Flow Charts - Decision Analyses with Decision Tree and with Decision Models - SWOT Analysis • Risk Analysis - the Risk Taxonomy - Threat Community diagram
<p>Analysis</p>	<p>The Analysis category provides Perspectives for:</p> <ul style="list-style-type: none"> • All Analysis - all modeling tools and objects provided by the other Perspectives in this group • Custom Diagram Style - the 'Simple Style' diagram rendering for presentations and non-technical display of information • Amazon Web Services (AWS) - for creating Amazon/AWS diagrams in Enterprise Architect • Google Cloud Platform (GCP) Icons - for creating Google Cloud Platform diagrams • Microsoft Azure - a new Image library of graphics (icons and images) required to model Microsoft Azure deployments • Whiteboards - diagram structures in Whiteboard and/or Hand-drawn mode

	<ul style="list-style-type: none"> • Simple Analysis, based on a Two Activity Process • Case Management Model and Notation (CMMN) analysis, with a: <ul style="list-style-type: none"> - Claims Management example - Basic 5-Task Plan - Three Choice Tasks Pattern - Two Phase Case Plan • Eriksson-Penker Business Extensions (EPBE) modeling, the basic business process • Web Stereotypes, based on a simple Java Server Page (JSP) model • Threat Modeling
Requirements	<p>The Requirements category provides Perspectives for:</p> <ul style="list-style-type: none"> • All Requirements - all modeling tools and objects provided by the other Perspectives in this group • Creating a range of Requirement Hierarchy diagrams, and a Requirement Specification View • Working with Decision Model and Notation (DMN) to: <ul style="list-style-type: none"> - Create a simple Decision diagram with a Decision Table - Set up a DMN Business

	<p>Knowledge Model</p> <ul style="list-style-type: none"> - Model a DMN Decision • Setting up a Modeling Business Rules model • Setting up one-level and two-level Data Flow Diagrams models
<p>UX Design</p>	<p>The UX Design category provides a number of Perspectives for modeling user interfaces on various devices, including:</p> <ul style="list-style-type: none"> • All UX Design - all modeling tools and objects provided by the other Perspectives in this group • User Interaction & Experience for various phone and tablet devices • Interaction Flow Models IFML Interaction flows on desktop applications, information entry, interaction on wireframe devices, and information searches • A basic Enterprise Architect user interface model for a window with lists and combo boxes • An alternative simple user interface • Win32 User Interface Dialogs
<p>Business Modeling</p>	<p>The Business Modeling category provides these Perspectives:</p>

All Business Modeling - all modeling tools and objects provided by the other Perspectives in this group

- [Business Process Model and Notation \(BPMN\)](#) - Patterns for:
 - BPMN 2.0 modeling
 - BPEL 2.0 Starter model
- [BPSim Business Simulations](#) - Patterns for BPMN 2.0 and BPEL 2.0 modeling, plus:
 - Patterns for Business Process Simulation (BPSim) constructs and
 - Patterns for a number of BPSim Case Studies
- [Business Motivation Model \(BMM\)](#)
- Business Model Patterns for Business Use Case models and Use Case Realization
- [Business Modeling/Interaction](#) model Patterns
- BABOK - a wide range of Patterns supporting models for:
 - Strategies
 - Collaboration activities
 - Analyses
 - Business Processes
 - Project Management activities
 - Standard business documents
- BIZBOK - Patterns for modeling

	<p>BIZBOK activities</p> <ul style="list-style-type: none"> • Value Delivery Modeling Language (VDML) - Patterns for modeling in Value Data Markup Language
<p>Software Engineering</p>	<p>The Software Engineering category provides Perspectives for software development, including:</p> <ul style="list-style-type: none"> • All Software Engineering - all modeling tools and objects provided by the other Perspectives in this group • Code Engineering, modeling programs in a number of programming languages • Service Oriented SOMF 2.1, for several Conceptual Association types • SoaML, for modeling aspects of basic service provision • XSLT Feature demonstrations, such as XSLT transforms and debugging • WSDL - providing a complete WSDL template model • XML Schema - providing an XML Schema Package and diagram • ICONIX modeling • Gang of Four (GoF) Patterns Patterns for Creational, Structural and Behavioral models

Systems Engineering	<p>The Systems Engineering category provides Perspectives to support Systems Engineering projects:</p> <ul style="list-style-type: none">• All Systems Engineering - all modeling tools and objects provided by the other Perspectives in this group• Systems Modeling Language (SysML), with a wide range of Patterns for generating:<ul style="list-style-type: none">- Project structures- Requirements diagrams- Use Case diagrams- Activity diagrams- Block Definition diagrams- Internal Block diagrams- Parametric diagrams- StateMachine diagrams- Libraries- Model elements- OpenModelica Case Studies• UAF, with Patterns for:<ul style="list-style-type: none">- Strategic Views (St-xx)- Operational Views (Op-xx)- Services View (Sv-xx)- Personnel Views (Pr-xx)- Resources Views (Rs-xx)- Security Views (Sc-xx)- Projects Views (Pj-xx)- Standards Views (Sd-xx)
---------------------	---

- Actual Resources Views (Ar-xx)
- Dictionary View (Dc)
- Requirements View (Rq)
- Summary and Overview (SmOv)
- Information View (If)
- Parameters Views (Pm-xx)
- The SysML 1.5 sets (as listed, except for OpenModelica Case Studies)
- [Unified Profile for DoDAF/MODAF \(UPDM\)](#) with Patterns for:
 - UPDM Frameworks (DoDAF and MODAF)
 - DoDAF All Viewpoints (AV-n)
 - DoDAF Capability Viewpoints (CV-n)
 - DoDAF Data and Information Viewpoints (DIV-n)
 - DoDAF Operational Viewpoints (OV-n)
 - DoDAF Project Viewpoints (PV-n)
 - DoDAF Services Viewpoints (SvcV-n)
 - DoDAF Standard Viewpoints (StdV-n)
 - DoDAF Systems Viewpoints (SV-n)
 - MODAF All Views (AV-n) Viewpoints
 - MODAF Acquisition (AcV-n)

	<p>Viewpoints</p> <ul style="list-style-type: none"> - MODAF Operational (OV-n) <p>Viewpoints</p> <ul style="list-style-type: none"> - MODAF Service Oriented Views (SOV-n) <p>Viewpoints</p> <ul style="list-style-type: none"> - MODAF Strategic Views (StV-n) <p>Viewpoints</p> <ul style="list-style-type: none"> - MODAF System Viewpoints (SV-n) - MODAF Technical Standards Views (TV-n) <ul style="list-style-type: none"> • Executable StateMachines, with various Patterns including a set to demonstrate case studies • Matlab/Octave Solvers • AUTOSAR, by LieberLieber - sets of patterns for creating models in accordance with the AUTOSAR 4 Virtual Function Bus specification in LieberLieber AUTOSAR Engineer • MARTE - a range of UML-type Patterns for creating diagrams under the 'Modeling and Analysis of Real Time and Embedded systems' profile from the OMG
<p>Simulation</p>	<p>The Simulation category provides Perspectives to allow easy access to the wide variety of Simulation technologies</p>

	<p>available in Enterprise Architect:</p> <ul style="list-style-type: none"> • All Simulation - all modeling tools and objects provided by the other Perspectives in this group • SysML with Modelica • UML Behavioral • Executable StateMachines • Matlab/Octave Solvers • BPSim • Decision Modeling • Executable Business States • Win 32 UI Models
<p>Database Engineering</p>	<p>The Database Engineering category provides sets of Perspectives for modeling a range of DBMS repositories, including:</p> <ul style="list-style-type: none"> • All Database Engineering - all modeling tools and objects provided by the other Perspectives in this group • Starter Model and Model Structure Patterns for each of the main DBMSs supported by Enterprise Architect • Data Warehouse Architecture • Data Warehouse Schema • Patterns for simple Entity Relationship Diagrams (ERDs) models

	<ul style="list-style-type: none"> • Patterns for simple ArcGIS Geodatabases projects and workspaces
<p>Enterprise Architecture</p>	<p>The Enterprise Architecture category provides a number of Perspectives for Enterprise Architecture frameworks, including:</p> <ul style="list-style-type: none"> • All Enterprise Architecture - all modeling tools and objects provided by the other Perspectives in this group • ArchiMate Modeling Language, supplying Patterns for: <ul style="list-style-type: none"> - Basic viewpoints such as Organization, Application Usage and Service Realization - Motivation Viewpoints such as for Stakeholders, Principles and Requirements Realization - Strategy Viewpoints - Implementation and Migration Viewpoints • The Open Group Architecture Framework (TOGAF), with Patterns for: <ul style="list-style-type: none"> - A Starter Model - The Architecture Development Method - The Enterprise Continuum - The Technical Reference Model

	<ul style="list-style-type: none"> - Catalogs • The Zachman Framework • GRA-UML annotations library and starter model • The Essential Architecture (TEA)
<p>Information Exchange</p>	<p>The Information Exchange category supports a number of built-in technologies, providing Perspectives and basic model Patterns for:</p> <ul style="list-style-type: none"> • All Information Exchange - all modeling tools and objects provided by the other Perspectives in this group • Ontology Definition Metamodel • Geography Markup Language (GML) • Archetype Modeling Language (AML) • National Information Exchange Modeling (NIEM) 3.0, 3.1, 3.2 and 4.0 Reference Models and NIEM 3 and 4 starter models • SIMF • Universal Business Language (UBL) • UML Profile for Core Components (UPCC) • UMM 2.0 Profile
<p>Publishing</p>	<p>The Publishing category provides</p>

	<p>Perspectives for communicating information on the model, including:</p> <ul style="list-style-type: none"> • All Publishing - all modeling tools and objects provided by the other Perspectives in this group • Document Generation • Standard Charts • Dynamic Charts • Diagram Legends to define how diagram legends are set up and used • Model Glossary • Help Authoring • Process Guidance - working up process templates
<p>Construction</p>	<p>The Construction category provides these Perspectives:</p> <ul style="list-style-type: none"> • All Construction - all modeling tools and objects provided by the other Perspectives in this group • Project Management, for Project Management and Roadmap diagrams • Kanban Boards workflows • Reviews and Discussions to define the structure and function of these team collaboration activities • Construction View to show a simple

	<p>Construction rendering of an element with its management items, and more complex diagrams that include the elements related to the Construction element</p> <ul style="list-style-type: none"> • Test Management to define how tests are planned and managed • Change Management to define a model for managing issues and changes • Scriptlets • The Data Miner • Software & Systems Process Engineering Meta-Model (SPEM)
<p>Custom Technologies</p>	<p>The Custom Technologies category provides Perspectives to support:</p> <ul style="list-style-type: none"> • All Management - all modeling tools and objects provided by the other Perspectives in this group • The MDG Technology Builder • Model Perspectives • Model Add-Ins

Using Perspectives

You can access both built-in and custom Perspectives from a number of different points. This makes it easy to start your work in the appropriate environment with the required Perspective from any point, and to quickly and smoothly switch to a different Perspective if the need arises.

Conversely, if you prefer to have a wider range of tools and languages immediately available to you, you can select the appropriate 'All <perspective group name>' option in the Model Builder or  list to filter for all Perspectives for a domain.



Note that if a 'Perspective for Security Group' has been set for the model and you are a member of that security group, you will not be able to change the visibility of Perspectives as that will be defined by the administrator for the group.

Access

Currently, selecting a built-in Perspective will take you to the Model Builder dialog. Some access paths first take you to the Perspectives Portal, and when you select a Perspective from there the Model Builder dialog is opened and you choose the appropriate Patterns to use (if required).

Other paths take you directly to the Model Builder, where you first select the Perspective and then the Patterns to use (if required).

Ribbons	Start > All Windows > Perspective >
---------	-------------------------------------

	<p><perspective group> > <perspective> Start > Explore > Portals > Perspectives > <perspective group> > <perspective> Start > Personal > Model Builder > <perspective group> > <perspective> Design > Package > Model Builder > <perspective group> > <perspective></p>
Context Menu	<p>Right-click on Package > Model Builder (pattern library) > <perspective group> > <perspective></p>
Other	<p>(Top right corner of screen) >  > <perspective group> > <perspective> ('My Perspective' options just apply the custom Perspective)</p> <p>Navigator Toolbar :  :  > <perspective group> > <perspective></p>

Use a Perspective

Having selected a Perspective, and depending on what Perspective that is, you would expect to see impacts on the Model Builder dialog, 'New Diagram' dialog, Diagram Toolbox and 'Stereotypes' dialog, each offering fewer options more specific to the Technology or operations you

are working in. For Perspectives related to Code Engineering, the code editors and code generators might also have a narrower focus.

As you develop models and/or engineer code, you will see the structures you require and not have to pick them out from many other structures of no relevance to the work you are doing.

Filter Perspectives Available

You are unlikely to use all the Perspectives available in Enterprise Architect, so if you prefer you can exclude the individual Perspectives - or complete Perspective Sets - that you do not need from display in the Model Builder and  selection lists. You do this using the 'Perspective Sets' dialog:

Start > All Windows > Perspective > Settings

The 'Perspective Sets' dialog defaults to the 'System Sets' tab. If you want to exclude a complete Perspective Set, deselect the checkbox against that category in the 'Perspective Sets' panel.

Otherwise, if you want to just exclude individual Perspectives click on the parent Perspective Set name and, in the 'Perspectives' panel, deselect the checkbox against the Perspective name. In this illustration, the CMMN and Erikson-Penker Model Perspectives have been excluded from display.

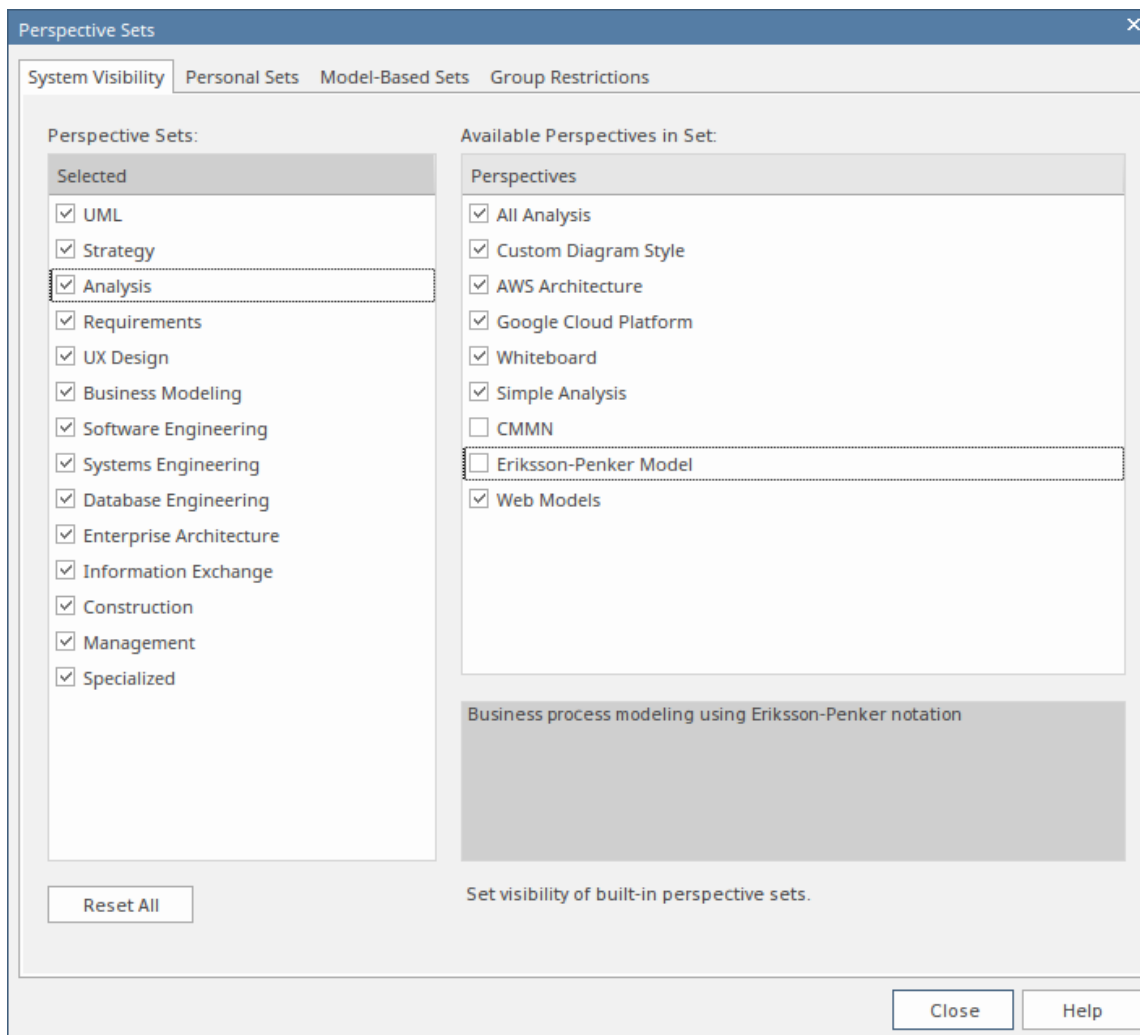

Note that if you exclude a Perspective Set, the checkboxes against the individual member Perspectives remain selected. However, the Perspectives do not show in the selection lists in, say, the Model Builder.

If you decide to show any excluded Perspectives again, return to the dialog and select the appropriate checkboxes. Alternatively, show all Perspectives as explained in *Revert to All Perspectives*.

Revert to All Perspectives

If you have filtered your list of Perspectives, or been

working within a specialized Perspective such as Requirements or a customized Perspective, and you want to return to a non-specific environment, either:

- Select the 'Start > All Windows > Perspective > Settings' ribbon option to display the 'Perspective Sets' dialog, and click on the Reset All button or
- Select  > All

Notes

- A Perspective hides all Technologies that are not specifically associated with it; if you use custom Technologies in your work, add them to a custom Perspective with any built-in Technologies you want to use, so that all your specialized tools are available together
- An individual Technology might not present all facilities you need (for example, ICONIX does not have a diagram profile, so a Perspective that just exposes ICONIX does not allow you to create diagrams); select or create a custom Perspective that includes a Technology that adds the missing facilities (in this case, the UML Technology)
- In order to function when included in and presented by the Perspective, a Technology must remain enabled in the 'Manage Technologies' dialog

Customizing Perspectives

Whilst Enterprise Architect boasts a wide range of system (built-in) Perspectives, as users and teams gain more experience with the huge number of technologies and features in the tool, or their roles change, they might want to create their own personal or model based Perspectives more specifically tailored to their area of work, or to expose Technologies they have recently imported. Enterprise Architect provides the ability for Perspectives to be completely customized down to the level of the items that appear on a technology Toolbox page, and these definitions can be created once and then reused by different team members or even across different repositories.

Before starting, review the Technologies available to you in Enterprise Architect and identify and enable those you want to apply in a Perspective, either individually or in combination. This is particularly important for any custom Technologies you have, as selecting a Perspective makes available only those Technologies it specifically contains and hides all others - including your custom Technologies.

You can create custom Perspectives for your own personal use, or for all model users, and move or copy individual Perspectives between the two levels. You can also publish custom Perspectives, exporting them as a set from one model and importing them as a set into other models.

The procedures for working with personal custom Perspectives and model-level custom Perspectives are the same, except where specifically stated in this topic.

If you have User Security enabled on a model or project, as an administrator you can also set up Perspective Settings that identify the Perspectives available to users in each of the defined security groups. See the *Perspectives for Security Groups* Help topic.

Access

These access options display the 'Perspective Sets' dialog, through which you can create customized Perspectives.

Ribbon	Start > All Windows > Perspective > Settings... > Personal Sets or Shared Sets
Perspective drop-down	Open the Perspective drop-down menu located in the top-right corner of the main window. Select 'Settings...' from the bottom of the list. The settings can also be loaded from other places in Enterprise Architect that show the Perspective drop-down menu. Then select Personal Sets or Shared Sets

Create Custom Perspective

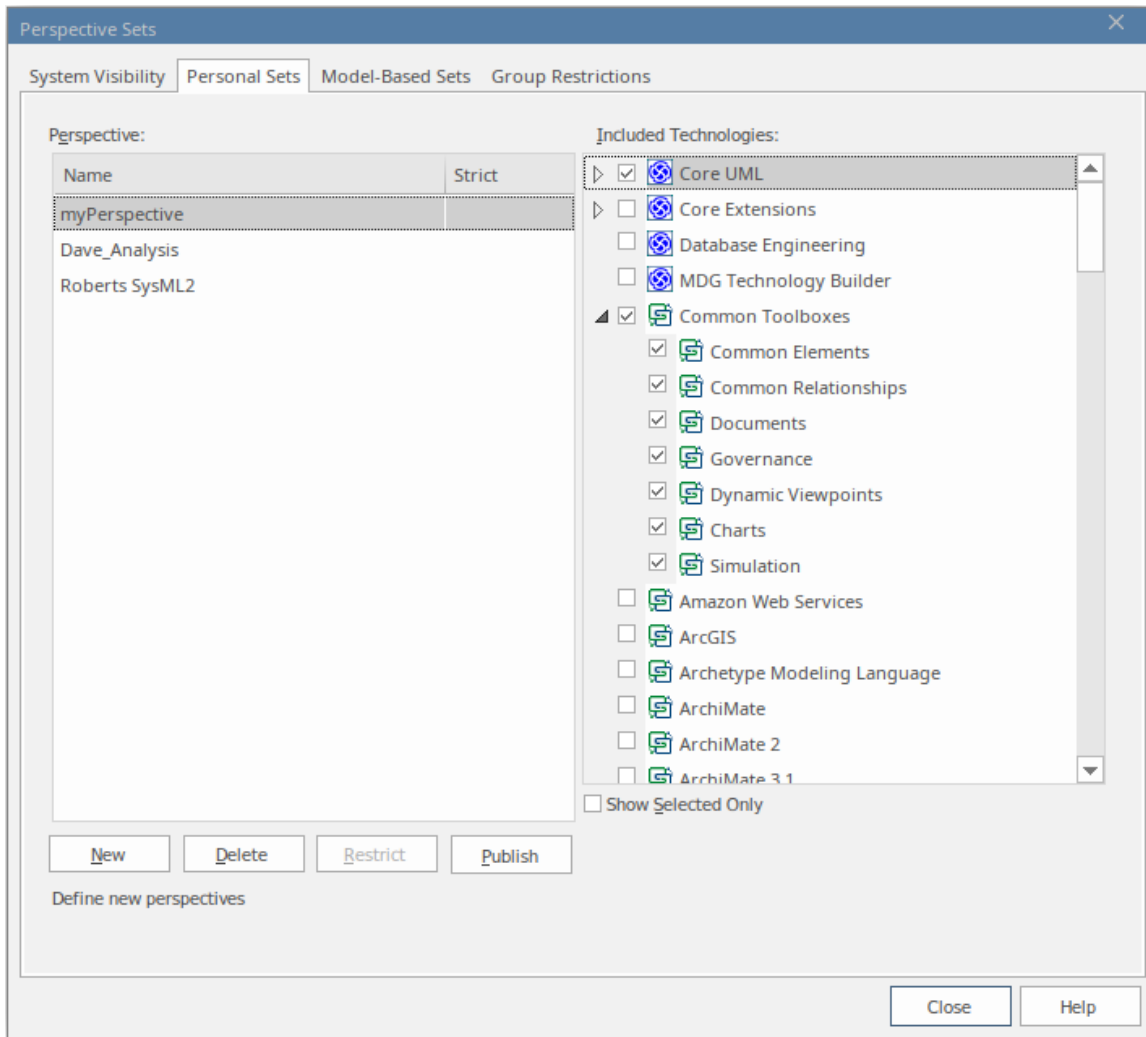

Step	Action
1	<p>Click on the New button. The 'Create Perspective' dialog displays, prompting you for the name of the new Perspective. Type in the Perspective name.</p> <p>In your Perspective, you can restrict the creation of constructs (types of diagram, element, connector and Pattern) from within other Technologies. (See the Restrict Custom Perspective section later</p>

	<p>in this topic.) If you want to do this, select the 'Strict' checkbox.</p> <p>Click on the OK button. The name is added to the 'Perspective' panel.</p> <p>If you have selected the 'Strict' checkbox for a Perspective, the word 'Yes' displays in the 'Strict' column and the Restrict button is enabled.</p>
2	<p>The new Perspective will be selected. Tick the technologies to be included in the Perspective. Untick any technologies that should not be in the new Perspective. Tick the 'Show Selected Only' checkbox to quickly see only the technologies that are currently ticked.</p>
3	<p>You can also edit the Perspective name, and clear or select the 'Strict' checkbox; right-click on the Perspective name and select the 'Edit' option. The 'Edit Perspective' dialog displays, on which you can overtype the name and/or alter the checkbox selection. Then click on the OK button.</p>
4	<p>When you have finished setting up or</p>

	changing a Perspective, click on the Save button, or click on the Close button and you will be prompted to save any changes.
--	--

Manage Modeled Perspectives

Enterprise Architect 17.0 adds a new tab to manage Perspectives that are modeled using the new Perspective Modeling stereotypes.

The list shows all <<perspective workspace>> elements in the model that are used to encapsulate modeled perspective and ribbon sets.

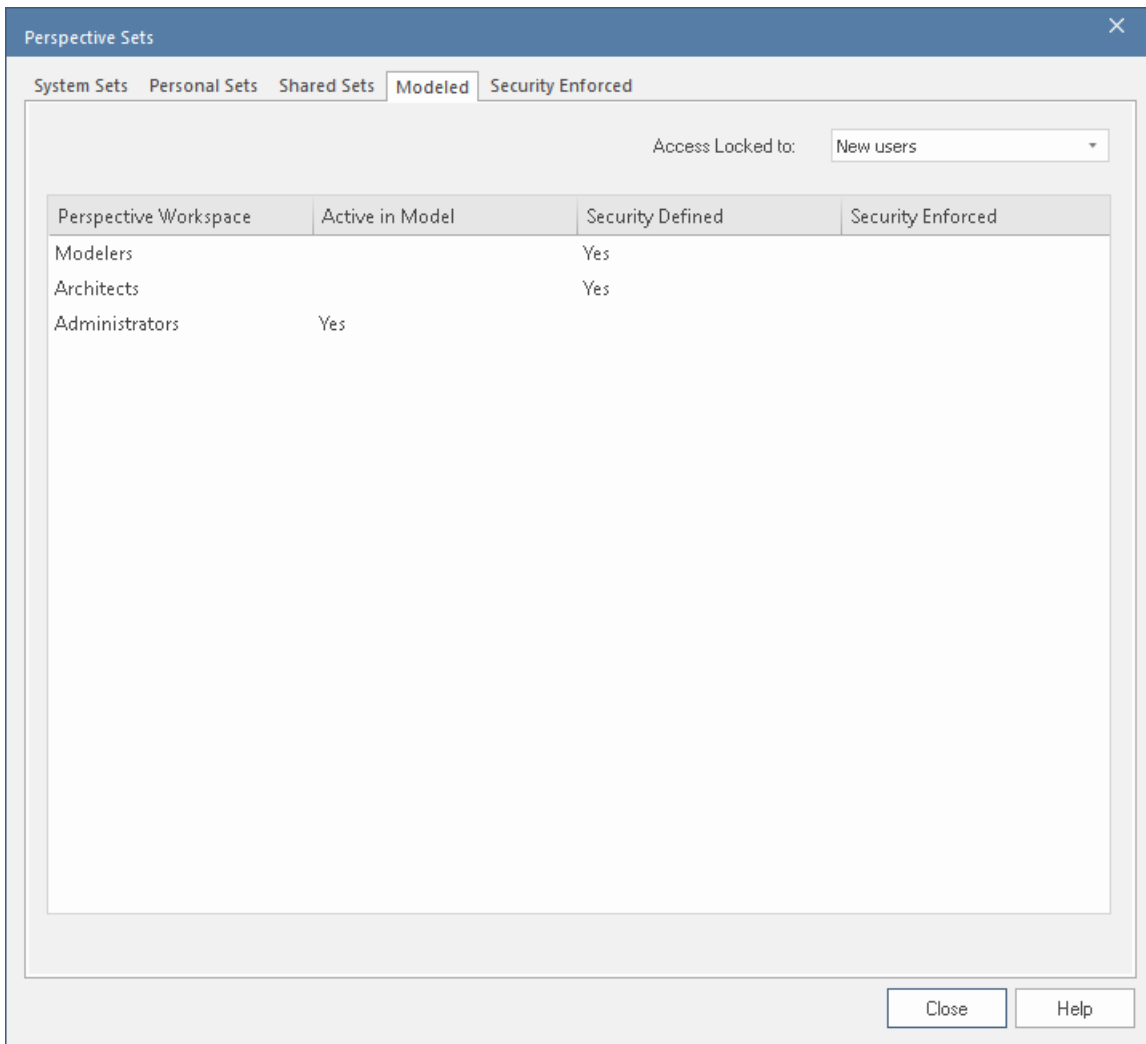

Active in Model

If 'Yes' then this Perspective Workspace has been activated in the model and can be viewed in the Shared Sets tab.

Right-click on the row to update with any changes to the modeled perspective, or to de-activate to remove it from the Shared Sets

If blank then this Perspective Workspace has not been activated in the model and will not be available to select. Right-click

	to activate the Perspective Workspace - choose to also link the Security Groups if available.
Security Enabled	If 'Yes' then this Perspective Workspace has a linked <<security group>> element and can be used to restrict users in the linked group to only be allowed access to this Perspective Workspace.
Security Enforced	If 'Yes' then this Perspective Workspace has been activated in the model and is linked to a Security Group the will restrict uses in that group to only be able to access perspectives, technologies and ribbons as defined in the <<perspective workspace>>. These will be listed in the Security Enforced tab.

Restrict a Custom Perspective

Enterprise Architect is a tool for all seasons and is used to create models for initiatives of all sizes, from small endeavors such as a website for a small retail store right up to highly complex systems used in aerospace missions. Many of the supported languages and technologies also have this dimension, defining mechanisms for simple grammars

through to extremely complex mechanisms for modeling large real-time systems.

Enterprise Architect provides the Strict Perspectives as a mechanism to restrict users to just the subset of the technology and the tool that they need to undertake their modeling tasks. For example, there might be a group of strategic modelers who just need to model straight-through processing. They only need access to the basic BPMN modeling palette such as Activities and Control Flows, and are not concerned about Pools, Lanes Gateways and Message Flows, for example, and certainly don't want to see Choreography diagrams. The librarian could set up a Strict Perspective restricted to just these modeling elements, connectors and diagrams.

To set a custom Perspective to 'Strict', click on the Perspective name and click on the Restrict button. The 'Modeling Permissions/Restrictions' dialog displays, listing the constructs (diagram, element, connector and Pattern) of each Technology in the Perspective.

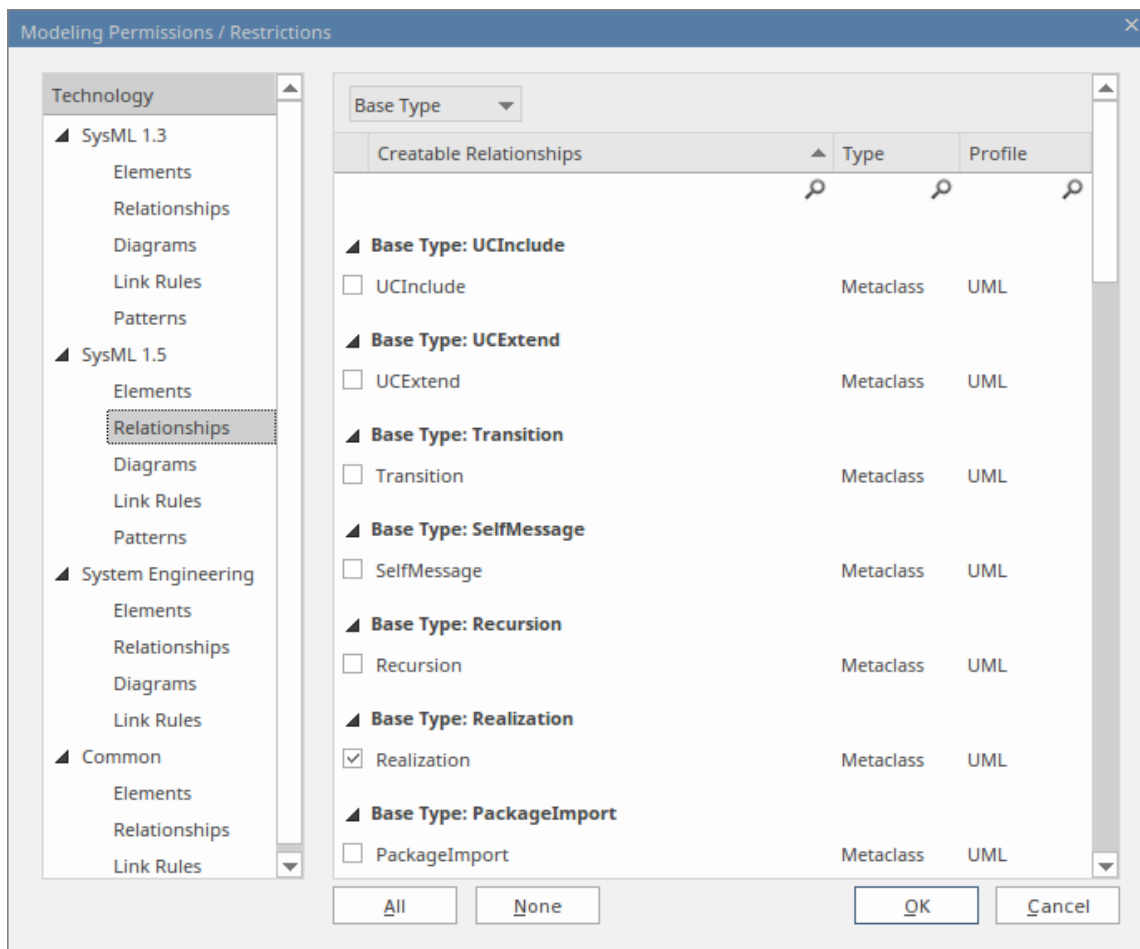

Click on the type of construct for each Technology in turn, and in the lists in the right-hand panel select the checkbox against each type of element, relationship, diagram, link rule or Pattern to allow in the Perspective. If it makes the process easier, use the All button or None button to select all checkboxes or clear all checkboxes before checking or clearing individual entries.

When you have finished setting the allowed constructs, click on the OK button to return to the 'Perspective Sets' dialog.

Publish Custom Perspectives

If you have custom Perspectives in one model, you can publish them by exporting them as a set to file and

importing them into other models.

1. On the appropriate tab ('Shared Sets' or 'Personal Sets'), click on the Publish button to display the 'Publish Perspectives' dialog.

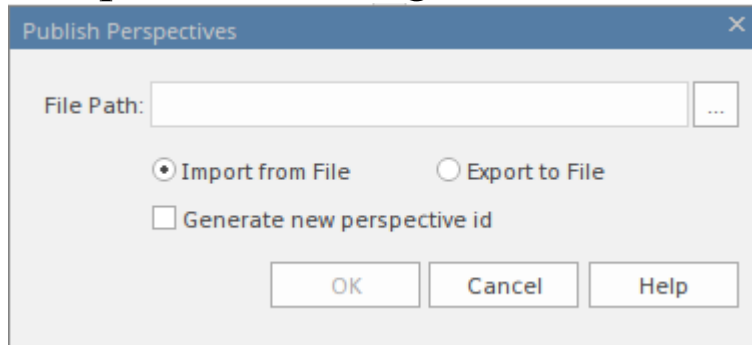

2. In the 'File Path' field, type in or browse for the location of the external file:
 - From which to import previously-captured custom Perspectives, or
 - Into which to export the current set of custom Perspectives
3. Select the appropriate radio button for the import or export operation you are performing.
4. Click on the OK button. The exported Perspectives are copied to the specified file. Imported Perspectives are listed on the 'Perspective' panel of the 'Shared Sets' or 'Personal Sets' tab, as appropriate.

Move or Copy Custom Perspectives

If you have created a Perspective in either the 'Shared Sets' tab or the 'Personal Sets' tab, you can move or copy that Perspective from its source tab to the other. You might move a Perspective to make yours available to other users,

or to restrict a model Perspective to your own use, or copy the Perspective and edit it to create a variant for general or personal use.

Right-click on the selected Perspective to move or copy that Perspective, or click in the white space of the 'Perspective' panel to move or copy all Perspectives in the list. A short menu provides options to move or copy the Perspective to the alternative group - 'Shared Sets' or 'Personal Sets'. Click on the appropriate option; the move or copy takes place immediately and the Perspective name is displayed in the target panel.

Delete a Custom Perspective

If you no longer want to use a custom Perspective, you can delete it from the list of those available.

On the 'Shared Sets' or 'Personal Sets' tab of the 'Perspective Sets' dialog, click on the custom Perspective name and then on the Delete button.

In response to the confirmation prompt, click on the Yes button.

Perspectives for Security Groups

Perspectives can be integrated with User Security, allowing administrators and librarians to define the set of Perspectives available to a given security user group. This ensures that users in the group have all the tools and languages they need, whilst helping them focus on their work by completely hiding any irrelevant tools that might otherwise be distracting. This results in productivity gains, while still allowing the modelers to switch between Perspectives that have been assigned to them. So, for example, a security group called *Strategic Process Modelers* could be defined and an administrator could assign to it the entire *Strategy* Perspective set and the *Decision Modeling* Perspective from the *Requirement* set. All users assigned to this group would have access to, and be able to switch between, the individual Perspectives or, by selecting *All*, would be able to access the technologies in all their Perspectives. Users who have been assigned as members of a number of groups will have available to them the amalgam (union) of all their groups' Perspectives.

An administrator or librarian who has defined fine-grained technologies using the strict and restricted feature can apply these restricted Perspectives to any group, thus ensuring that the members of the group have only the restricted set of elements, connectors and diagrams from the specified technology. For example, there might be a group of strategic modelers who just need to model straight-through processing. They only need access to the basic BPMN

modeling palette such as Activities and Control Flows, and are not concerned about Pools, Lanes, Gateways and Message Flows, for example, and certainly don't want to see Choreography diagrams. The librarian could set up a Strict Perspective restricted to just these modeling elements and connectors and diagrams. They then apply it to the group *Strategic Process Modelers* and ensure the users are made part of that group using the 'Security Users' dialog, available from the 'Configure' ribbon. This gives an administrator fine grained control of what parts of the language their project team can use, resulting in boosts in productivity and outputs.

The model administrator can similarly tailor the ribbons available to each user security group, as a Ribbon Set for each group, so that particular ribbons can be hidden to further customize and focus the modelers' workspace.

It is important to note that the 'hidden' technologies are not disabled - the model is still logically correct and fully supported for every underlying technology; it is simply that a particular security group will not be able to model using the hidden technologies.

This feature is available in the Corporate, Unified and Ultimate Editions of Enterprise Architect, from Release 15.0.

Access

Ribbon	Start > All Windows > Perspective > Settings > Security Enforced
--------	--

On the 'Perspective Sets' screen, The 'Perspective Settings for Security Groups' panel displays, listing the existing security groups for which Perspective Sets have been defined. (Existing security groups that do not have a Perspective Setting will show in the list if the 'Hide Unconfigured' checkbox is deselected.)

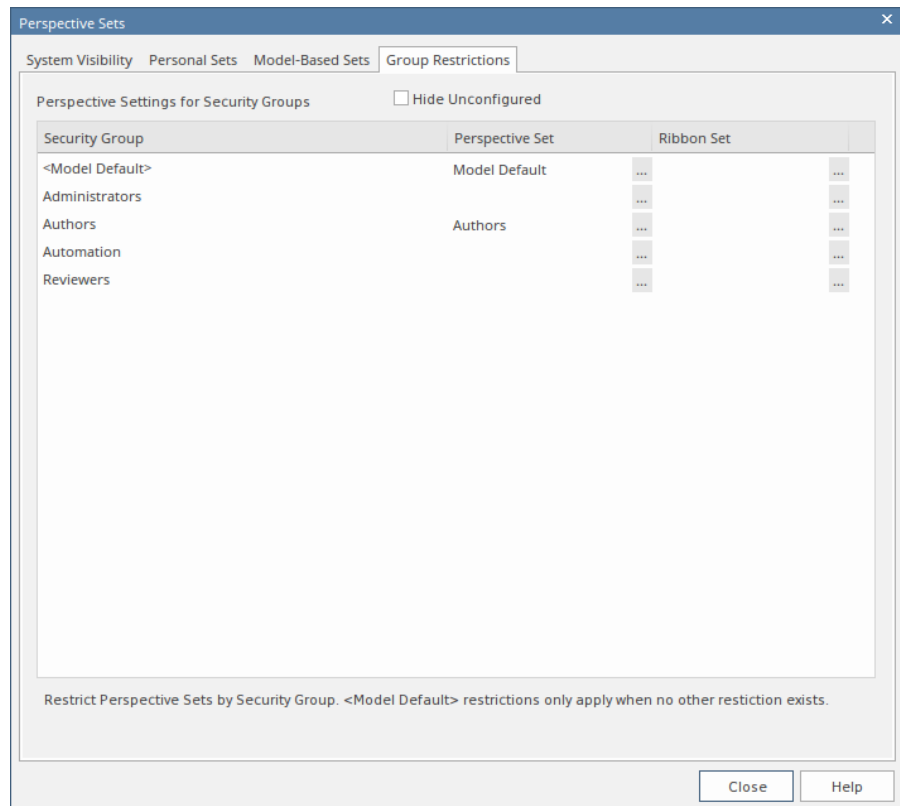

Notice that in the 'Perspective Set' column against the security group 'Authors' the value 'Authors' indicates the Perspective Setting that exists for that group.

At the top of the list is the group '<Model Default>', which enables you to refine the Perspectives and ribbons available to all

users of this model - it is effectively an 'all model users' security group.

Create or Edit a Perspective Setting for a Security Group

1. Click on the required security group name, then click on the  icon on the right of the field in the 'Perspective Set' column. The 'Perspectives for Security Group' dialog displays.

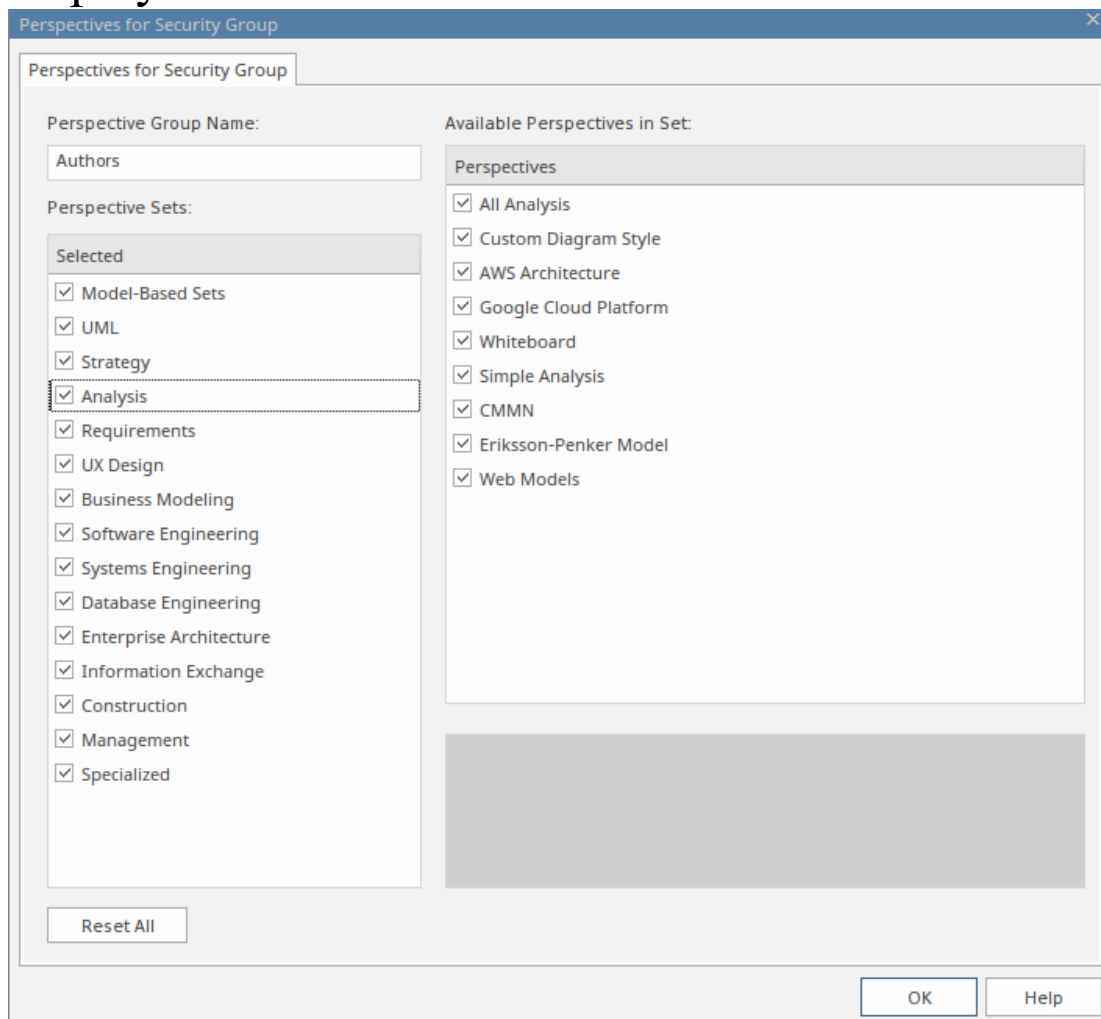

The dialog lists all of the Perspective Sets available in

Enterprise Architect and, when you click on the name of a Perspective Set, all of the Perspectives available in the selected set (as shown for the 'Analysis' Set). All Sets and Perspectives have checkboxes, which initially are all selected.

2. To make a complete Perspective Set unavailable to users in the security group, click on the corresponding checkbox to clear it.
3. To make individual Perspectives unavailable within an active Perspective Set, click on the corresponding checkboxes to clear them.
4. Work through all the Perspective Sets to define all the Perspectives that are not available to the users in the security group. If you want to reset all unselected checkboxes to selected, click on the Reset All button.
5. When you have defined the Perspective Setting, click on the 'Perspective Group Name' field and type in a name for the Perspective Setting for the security group.
6. Click on the OK button. The 'Perspective Settings for Security Groups' tab of the 'Perspective Sets' screen redisplay, with the name of the Perspective Setting in the 'Perspective Set' field for the selected security group.
7. You can repeat the process for another user security group.
8. When you have set up your Perspective Settings for the security groups, click on the Close button to close the 'Perspective Sets' screen.

Create a Ribbon Set for a Security Group

This process is similar to that for creating a Perspective Setting for a security group.

1. Click on the required security group name, then click on the  icon on the right of the field in the 'Ribbon Set' column. The 'Ribbon Set for Security Group' dialog displays.

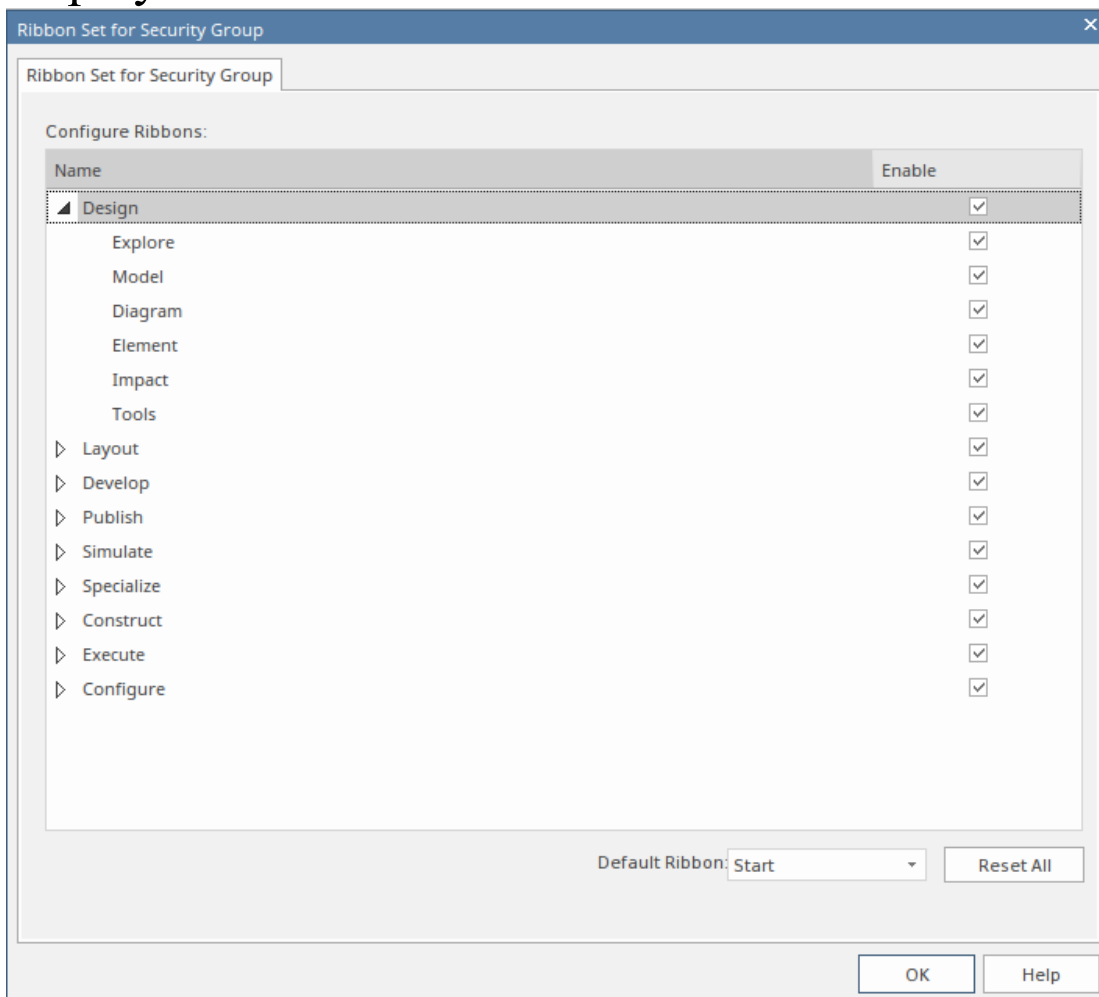

The dialog lists all of the ribbons available in Enterprise Architect and, when you expand the name of a ribbon, all of the option panels available in the selected ribbon (as shown for the 'Design' ribbon). All ribbons and panels have checkboxes, which initially are all selected.

2. To make a complete ribbon unavailable to users in the security group, click on the corresponding checkbox to clear it.
3. To make individual option panels unavailable within an active ribbon, click on the corresponding checkboxes to clear them. Clearing all the panel checkboxes for a ribbon also hides the complete ribbon (you cannot display an empty ribbon).
4. Work through all the ribbons to define all the option panels that are not available to the users in the security group. If you want to reset all unselected checkboxes to selected, click on the Reset All button.
5. When you have defined the Ribbon Set, you can also identify one ribbon as being the default that is shown whenever users in the selected security group open Enterprise Architect. Click on the drop-down arrow in the 'Default Ribbon' field, and select the required ribbon name.
6. Click on the OK button. The 'Perspective Settings for Security Groups' tab of the 'Perspective Sets' screen redisplay, with the name of the Ribbon Set in the 'Ribbon Set' field for the selected security group.
7. You can repeat the process for another user security group.
8. When you have set up your ribbon sets for the security groups, click on the Close button to close the 'Perspective Sets' screen.

Notes

- Only model administrators can edit these settings
- You cannot hide the 'Start' ribbon, 'Specification - Specify' ribbon or 'Document - Edit' ribbon, or any panels that they contain
- If the 'Settings' ribbon is hidden, the Model Administrator's login overrides that to ensure that the administrator can administer the model
- Using the Reset All button for a Perspective Setting or Ribbon Set effectively cancels any special settings for the security group, and gives the member users access to all Perspectives and ribbons

Perspective Modeling

Perspective Workspace

A perspective workspace package will contain a perspective workspace diagram on which a built-in perspective set can be modeled. Opening the perspective workspace diagram will make the Model Perspectives toolbox appear. The rest of this section describes the elements and packages used on a perspective workspace diagram.

Once you have finished modeling a built-in perspective set, select the perspective workspace package and use the **ribbon > Specialize > Publish Perspective** command to open the Perspective Sets dialog where you will be able to load and activate the perspective workspace.

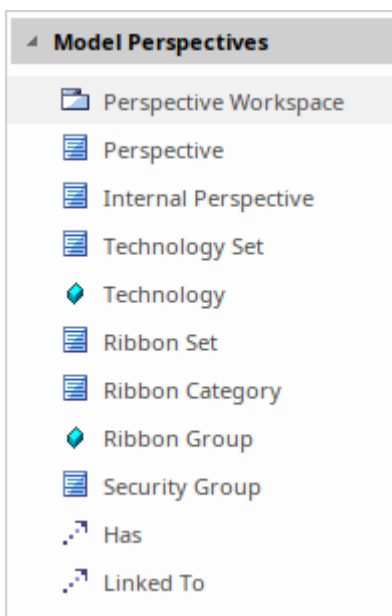

Perspective

A perspective is represented by a Class with the <<perspective>> stereotype. After importing a perspective workspace, the names of the perspective elements in the workspace will appear under Perspective > Model-Based Sets. A perspective has technology sets and is linked to security groups.

Technology Set

A technology set is represented by a Class with the <<technology set>> stereotype. The name of a technology set element is not important; it is not used anywhere else. It is a set of technologies, represented by <<technology>> attributes, that make up all or part of a perspective. A perspective can have multiple technology sets, and a technology set can belong to multiple perspectives. You can set restrictions on this technology set using the right-click > Set Restrictions to command. A technology set has tagged value Strict which can be set to true.

Technology

A technology is represented by an Attribute with the <<technology>> stereotype. When you drop a technology attribute from the toolbox onto a technology set element, a dialog will allow you to pick from the full list of available technologies. But see the Technology Set Patterns, below, which create a technology set with all of its technologies, to save you having to select technologies one by one.

Ribbon Set

Ribbon sets are linked to security groups. A <<ribbon set>> element, name not important, has <<ribbon category>> elements representing each ribbon category (Design, Layout, Develop etc - the Start category is always assumed present so is not modeled) each of which has <<ribbon group>> attribute for each ribbon panel (e.g. Design has Explore, Package, Diagram, Element and Dictionary). If you want to limit the ribbon commands a security group member can access, link the security group element to a ribbon set consisting of all the ribbon categories and groups they are permitted access to (it's an allow list). It is recommended that you drop the "Complete Ribbon Set" pattern on the diagram and remove the ribbon groups you don't want. A ribbon set element has a tagged value "default ribbon" which allows you to define which ribbon is made visible at startup. Unless otherwise declared, this will be the Start ribbon.

Ribbon Category

A ribbon category is represented by a Class with the <<ribbon category>> stereotype. A ribbon set has ribbon categories. A ribbon category can own ribbon group attributes. Ribbon categories are named for each ribbon on the main menu except Start, which is always assumed present and therefore not modeled.

Ribbon Group

A ribbon group is represented by an Attribute with the <<ribbon group>> stereotype and is owned by a ribbon category. Ribbon groups are named for each panel on a main ribbon. Use the Complete Ribbon Set pattern to create the full set of ribbon categories with their ribbon groups then you can easily remove the ones you don't want. This is much easier than adding everything you want, individually. To remove a ribbon group from the ribbon, simply delete the attribute.

Security Group

A security group is represented by a Class with a <<security group>> stereotype and can have ribbon sets linked to it. In a security-enabled model, drop a <<security group>> element from the toolbox and a dialog asks you to choose from all the security groups defined in the current model, if any. In a non security-enabled model, it only offers "<Model Default>". You can then link to or from all the perspectives, internal perspectives and ribbon sets that the security group can access.

Internal Perspective

An internal perspective is represented by a Class with the <<internal perspective>> stereotype. It is named for the

sub-menu on the perspective menu, e.g. UML, Strategy, Analysis. Linking an internal perspective to a security group makes all of the perspectives under the internal perspective available to the security group. For example, linking an internal perspective named Business Modeling to a security group makes the BPMN, BPSim, Business Motivation etc perspectives all available to the security group.

Internal Perspective Groups Pattern

This pattern will create one of every available internal perspective group. When you link a perspective to a security group, that security group will have an allow list of available perspectives; in other words, it won't have access to any of the built-in perspectives unless they are explicitly made available. Use this pattern to add the full set of internal perspective groups to the diagram then choose which ones to link to each security group, using the Linked To connector.

Complete Ribbon Set Pattern

This pattern will create one of every available ribbon category and populate it with every available ribbon group. (If you use this pattern as a security user with restricted ribbon set, you will get a reduced set of elements created). A ribbon set is defined as an allow list of ribbon categories and groups. To exclude a small number of groups or categories

from a ribbon set, drop this pattern onto a diagram, connect from ribbon set to each ribbon category using the <<has>> connector and then delete the category elements and group attributes that aren't required.

Technology Set Patterns

The Technology Set pattern can be imported from the Model Builder dialog. It includes a Technology Set element for every built in perspective provided with Enterprise Architect. These can be copied or moved into your perspective workspace and linked to one or more Perspective elements.

The Model Builder

The Model Builder provides Patterns from a wide range of technologies, which you can use to quickly generate new models in your project both when you first create the project and over time. From the Model Patterns you can create basic models that you can develop further as components of your project. You click on the ☰ menu icon at the top of the left-hand panel and select a Perspective Set from the drop-down list, which then shows a list of Pattern groups and the Patterns they contain. If you click on a Pattern, a description displays in the right-hand panel of the window, showing a type diagram (where appropriate) and an explanation of what the Pattern is and what it does. This description is drawn from an RTF file paired with the Pattern's source XML file.

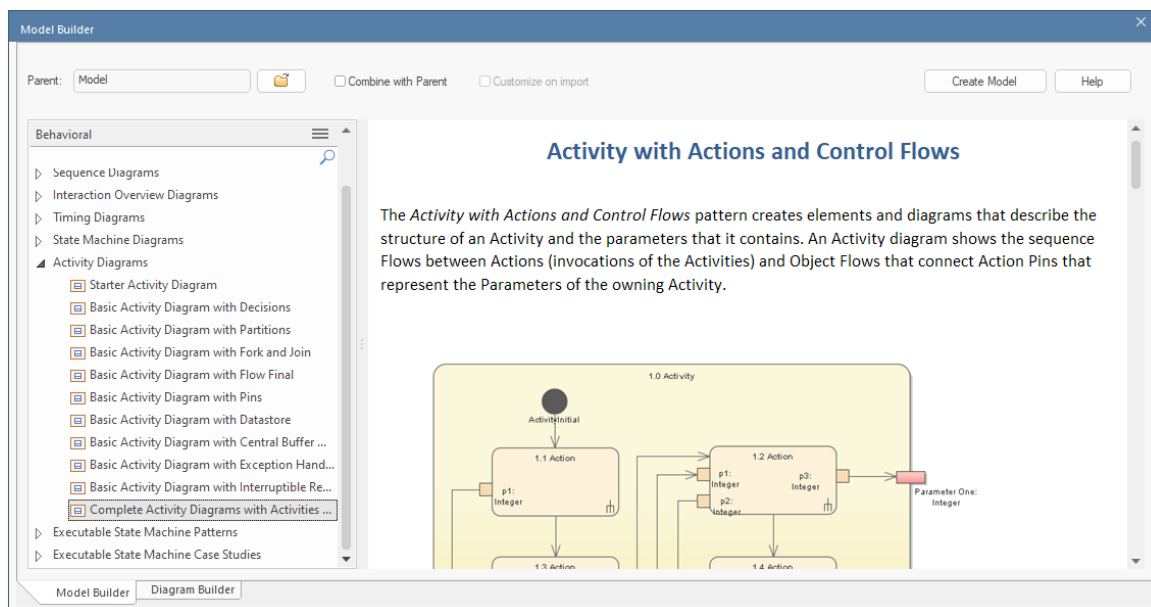

Access

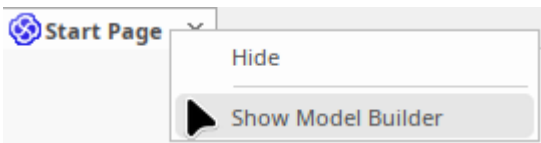
<p>Ribbon</p>	<p>Design > Package > Model Builder Start > Personal > Model Builder</p> <p>The Model Builder can be displayed as a main view or modal dialog. To display Model Builder Options, click on the drop-down arrow beside "Start > Personal > Model Builder":</p> <ul style="list-style-type: none"> • Start > Personal > Model Builder > Show Builder as Dialog • Start > Personal > Model Builder > Show Builder Page in Main View • Start > Personal > Model Builder > Show Builder Page on Startup
<p>Context Menu</p>	<p>Right-click on Package Model Builder Right-click on any Main View tab area Show Model Builder</p> 
<p>Keyboard Shortcuts</p>	<p>Ctrl+Shift+M</p>
<p>Other</p>	<p>Browser window caption bar :</p>

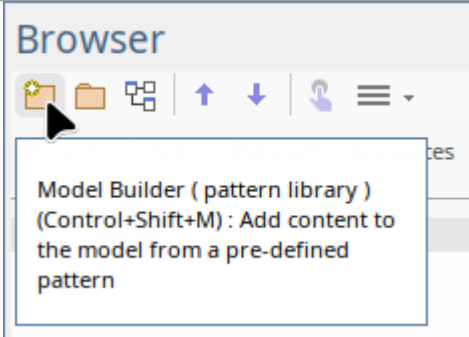

Browser window caption bar : ☰ >
Model Builder

Generate a New Model

Field/Button	Action
Perspective	<p>When you open the Model Builder window, the Pattern groups and Patterns available for the current Perspective are listed. Initially, the current Perspective is the one shown in the  <perspective name> icon at the top right of the application screen.</p> <p>If you click on the <perspective name> button or the ☰ button, a list of all the Perspective groups displays. As you mouse-over an option in the list, the Perspectives available in that group also display. When you click on a Perspective to select it, the panel is updated with the</p>

Pattern groups and Patterns provided by the selected Perspective. As you click on a Pattern in the list, a description is provided in the right-hand panel.

Note that selecting a Perspective from the <perspective name> button list does not change the current 'global' Perspective shown in the  <perspective name> icon. If you want to re-set the Model Builder Perspective to the global Perspective, simply click on the <perspective name> button and select 'Active'.

It is possible to make available every Pattern Group and Pattern available in the model; click on the button and select the 'All' option.

Conversely, you can restrict the list of Patterns shown by typing a text string in the Filter Bar underneath the button. Only Patterns that have that text string in their name are listed. This is also a useful tool for locating specific Patterns when you are not sure where they are held - select 'All' Perspectives and type the Pattern name in the Filter Bar field. The panel lists each Pattern that has the text string in its name

If you are a Technology Developer you can create and import your own MDG

	<p>Technology, and distribute one or more custom Model Patterns from that Technology through the Model Builder; the name of your Technology (or Technology categories) is added to the selection list under 'Specialized' for your users to access the Technology Patterns. To select a Model Pattern, simply click on it. If you want to select more than one Pattern, hold the Ctrl key down while you click on each Pattern.</p>
Create Model	<p>Click on this button to import a model structure derived from the Pattern(s) you have selected. The 'Importing Model Templates' dialog displays whilst the import is in progress, and any problems with the import are reported in the System Output window. The generated model structure displays under your selected Package in the Browser window.</p>
Parent	<p>Displays the name of the Parent package you have selected in the Browser window.</p> <p>If you need to change the package under which the model will be generated, click on the  icon and browse for the correct Parent package on the 'Navigator'</p>

	<p>browser.</p>
<p>Combine with Parent</p>	<p>Select this option to import the contents of the Pattern into the selected Package. When creating a Pattern, Enterprise Architect will normally create a new Package to represent the Pattern, as a child of the selected Package. If you select this checkbox, no new Package is created and instead the contents of the Pattern are added to the selected Package (provided that the selected Package is not a root node).</p>
<p>Customize on import</p>	<p>A Pattern can contain several Packages; select this checkbox to indicate that you will import only some of these Packages from the Pattern into your model. After you click on the Create Model(s) button, the 'Select Packages' dialog displays on which you specify which of the Packages to import.</p> <p>If you select more than one Pattern, the 'Select Packages' dialog displays for each Pattern in turn.</p> <p>If you do not select the checkbox, all Packages in each Pattern will be imported into the model.</p> <p>The option is disabled if there are too few</p>

	Packages to select from, or if it is not logical to import only some of the Packages.
--	---

Notes

- The 'Select Package(s)' dialog does not display for some of the Simple Template and Basic Template Patterns, even if the 'Customize Pattern on import' option is selected

Customize Model Content

When you set up a project by importing models using the Model Builder, you can generate the model structures from Patterns that you select in the Builder. Each Pattern can contain a number of Packages and sub-Packages, and it is possible to select which of these Packages to add to your model and which to omit, using the 'Select Packages' dialog. This is especially useful when setting up a new model with a reasonably complex structure, such as the TOGAF framework model. Being able to select which Packages are included and which are omitted is a good way to customize the level of implementation necessary for the current project.

Access

Ribbon	Design > Package > Model Builder > Select 'Customize Pattern on import' checkbox : Create Model button
Context Menu	Browser window Right-click on a Package node Model Builder (pattern library) Select 'Customize Pattern on import' : Create Model button
Keyboard	Ctrl+Shift+M Select 'Customize Pattern

Shortcuts	on import' : Create Model button
Other	Browser window caption bar menu Model Builder (pattern library) Select 'Customize Pattern on import' : Create Model button

Select Package(s) dialog

Option	Description
Select Package(s) to import from <pattern>	Shows the hierarchy of Packages contained in the Pattern, with a checkbox to the left of each item. The checkboxes are selected by default. Deselect the checkbox against each Package that you do not want to import. <ul style="list-style-type: none"> • Deselecting a Package automatically deselects all its child Packages • Re-selecting a Package automatically selects all its ancestor Packages
OK	Click on this button to import the selected Packages from the current Pattern.
Cancel	Click on this button to abort the creation

	of model structures from the current Pattern.
--	--

Model Views

The top-level Packages in a model (below the Model Root nodes) can be created as Views, which are simply used to structurally partition and extend the model according to specific requirements and modeling techniques, such as Component View or Dynamic View. These Views have the same concept as the Simple UML Views generated as Model Packages; however, unlike the Model Package views, basic Views:

- Do not have any automatically-generated components
- Can be created only under a Model Root node
- Are top-level Packages with different Package icons
- Are not directly available for Requirements, Analysis or Testing, although you can develop these Views from Simple Views or within Use Case Views

Types of View

There are seven main types of View, as listed here, each identified by a specific Package icon; the types of diagram we mention are suggested content for each View type, but you can add any structures you want to any View.

- Use Case View - containing Use Case diagrams and Analysis diagrams
- Dynamic View -containing Activity diagrams, Communication diagrams, Sequence diagrams and StateMachine diagrams

- Class View - containing Class diagrams, Code Engineering and Data Models
- Component View - containing Component diagrams
- Deployment View - containing Deployment diagrams
- Package View - containing either Package diagrams specifically, or any other Package content raised up to the highest level in the hierarchy; this View has the standard Package icon as used across the model
- Simple View - to customize your own type of view

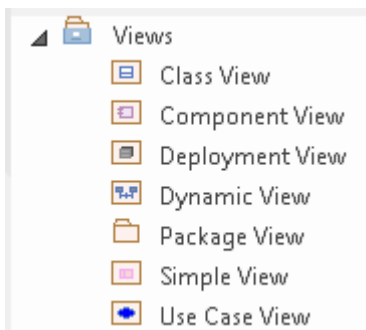

You can work within the first six standard View types, or devise your own type based on the Simple View.

You can create Views, change the View icon (see the *Rename Views* Help topic), and perform any operation available for other types of Package, by right-clicking on the selected View and choosing the appropriate context menu option.

Note that if you drag a Package from lower down in the hierarchy to just below the Model Root node, you can treat that Package as a View and change the View icon.

Conversely, if you drag a View to a position lower in the hierarchy, the View icon automatically changes to the standard Package icon.

Add Views

This example shows a customized view called Java Code View, which has been added to the end of the list of Views in the Browser window.

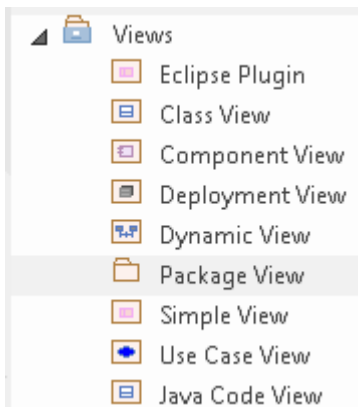

Access

In the Browser window, select a model root node, then:

Ribbon	Design > Package > Add Package
Context Menu	Right-click on root node Add View
Other	Package Browser caption bar menu New Package

Create a View

These fields are on the 'Create Package' dialog, which has a

'Set View Type' icon that is only active for View-level Packages.

Option	Action
Name	Type the name of the View (in the example, this is 'Java Code View').
	Click on this icon and select the appropriate menu option to set the icon to display next to the View name (the Java Code View has a Class icon).
OK	Click on this button to add the View to the Browser window.

Rename Views

If you decide to change the name of a View, you can do so very easily.

In renaming the View, you might want to change the icon next to the View name as well; this is equally easy to do.

Rename a View

Step	Action
1	Right-click on the View in the Browser window, and select the 'Properties Properties' option. Alternatively, click on the View name and press F2. The 'Package <name>' Properties dialog displays.
2	In the 'Name' field, type the new name and click on the OK button.

Change a View Icon

Step	Action

- 1 In the Browser window, right click on the View name and select the 'Set View Icon' menu option. The 'Set View Icon' dialog displays.

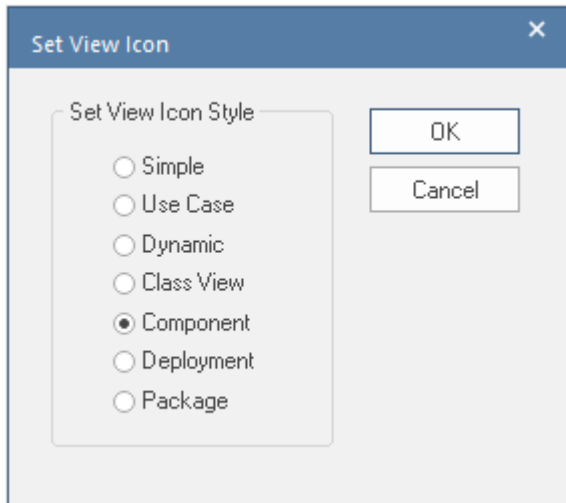

- 2 Click on the radio button for the type of icon you want to apply, then click on the OK button. The selected type of Package icon displays against the View name in the Browser window.

Delete Views

You can use Views as the main divisions of your project, or as temporary holding structures that you delete after you have redistributed any content you want to keep.

Delete a View

Step	Action
1	In the Browser window, right-click on the View to delete and select the 'Delete <viewname>' option.
2	<p>If you have selected the 'Confirm Deletes' checkbox in the Project Browser section of the 'Start > Appearance > Preferences > Preferences > General' dialog page, the system displays a warning that child elements are to be deleted.</p> <ul style="list-style-type: none">• To delete the View and its contents, click on the Yes button.• To cancel the deletion, click on the No button.

Notes

- If you delete a View, its contents are deleted at the same time; they cannot be restored

Model Packages



A Package is a grouping element that acts as a container for other modeling elements (including other Packages) and diagrams; Packages are represented in the Browser window as a familiar folder icon. Using the Package element, you can construct hierarchical models, allowing complex systems to be decomposed and categorized. Packages and their contents can be moved around freely in the Browser window, so that you can easily refactor the repository. Packages can be copied and pasted between model branches, renamed or viewed as a list.

Packages are important in Enterprise Architect because a number of functions can be applied at Package level, such as Baselineing, Version Control, Transformation and more. Formally, the Package is a Namespace for the members it contains, and a model element can be a member of one and only one Package. In software engineering and other formal modeling disciplines a Package can be set as a Namespace Root, which acts as the starting point of a given namespace.

Notes

- In the Corporate, Unified and Ultimate Editions of Enterprise Architect, if security is enabled you must have 'Update Element' permission to update or delete a Package

Annotation

An Annotation Package is a specialized form of Package that is automatically created when a parent Package has one or more diagrams that contain diagrammatic elements - non-model elements that have no purpose outside a diagram. Such elements include Notes, Text, Boundary elements and Navigation Cells. The Package does not have any properties (including not having a name), and is simply a container for those diagrammatic elements, allowing them to be listed in the Browser window and - if necessary - re-used in multiple diagrams. This also protects the elements from being deleted if the diagram that contains them is deleted. The Annotation Package is represented in the Browser Window by a blue Package icon followed by brackets.

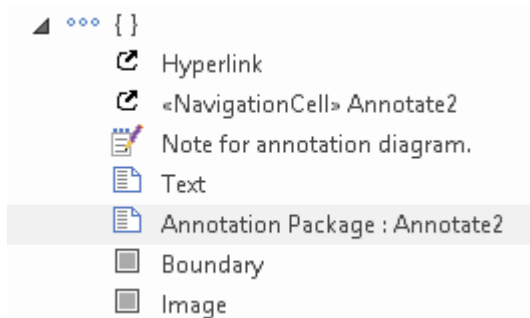

Add a Package

Adding a Package to a model is a simple but versatile process. It is possible to add a new Package to a View, Model Package or lower-level Package. In the process you can automatically:

- Create a Package using a specific Model Pattern
- Create a child diagram for the Package
- Add the new Package to the Version Control system that its parent object is under

Access

Ribbon	Design > Package > Add Package
Context Menu	Browser window Right-click on Package Add a Package
Keyboard Shortcuts	Ctrl+W
Other	Browser window caption bar menu New Package (📁)

Add a Package to the model hierarchy

Option	Instruction
Owner	Displays the name of the currently-selected Package or View, to which you are adding the new Package. If this is not the required owner Package, click on the  button and select the correct Package.
Name	Defaults to the automatic name, either 'Package n' or, if you have an autonaming scheme turned on, the defined name. If necessary, overtype this name with the preferred name of the new Package.
Select and Apply Model Pattern	Select this radio button to create the new Package from a Model Pattern.
Create diagram	Select this radio button if you want to immediately create a child diagram for the Package.
Package Only	Select this radio button if you want to just create a Package.
Add to Version	(Available if you are adding this Package to a parent object that is under Version

Control	Control.) Select this checkbox to add the new Package to the same Version Control system, deselect the checkbox to exclude the Package from Version Control.
OK	<p>Click on this button to create the Package in the Browser window.</p> <p>If you selected the 'Select and Apply Model Pattern' radio button, the 'Model Builder' dialog displays. Select the appropriate Perspective and Pattern to import.</p> <p>If you selected the 'Create diagram' radio button, the 'Model Builder' dialog opens, with its 'Diagram Builder' tab page displayed. Provide a name for the diagram and select the Technology and type.</p> <p>The new Package is inserted into the Browser window under the selected parent Package or View.</p>
Cancel	Click on this button to abort the changes you have made and close the dialog.

Notes

- You can also add a new Package element by dragging the Package icon from the Toolbox into a diagram; in this case the Package is created under the diagram's owning Package
- If the change is not immediately visible in the Browser window, click on the parent Package and press the F5 key to refresh it
- In a multi-user environment, other users do not see the change until they also press the F5 key or reload their project

Open Package in the Browser Window

When you access a model in Enterprise Architect, you can explore the contents of any Package in the Browser window by clicking on the white arrow to the left of the Package name, to expand the Package structure. You can, in an analogous way, collapse an expanded Package by clicking the black triangle to the left of the Package name. If the model has a default diagram (which displays automatically when you open a repository) the diagram's parent Package will already be expanded.

To display the Package's properties, select the Package name and view the docked Properties window.

Alternatively, right-click on the Package name and select the 'Properties | Properties' menu option; the Properties window displays for the Package.

Notes

- Package contents are arranged alphabetically, and elements can be dragged from one Package to another using the computer mouse
- To collapse the Package structure again, click on the black arrow to the left of the Package name in the Browser window
- To refresh the view of the Package contents, click on the Package in the Browser window and press the F5 key

Rename a Package

If you want to correct or change a Package name, it is very simple to do so using the 'Properties' dialog for the Package.

Access

In the Browser window, select a Package and:

Ribbon	Design > Package > Manage > Properties
Context Menu	Right-click on Package Properties
Keyboard Shortcuts	F2 Alt+Enter
Other	Double-click on Package

Rename a Package

Step	Action
1	In the 'Name' field, type the new name.

2	Click on the OK button.
---	-------------------------

Notes

- In a multi-user environment, other users do not see the change until they reload their project

Copy a Package

In developing your model, you might want to duplicate the structure and organization of a section so that, for example, you can replicate that part of the model in another model, or make it easier to cross-refer the contents of duplicate sections. You can quickly do this by copying a complete Package, including its child Packages, elements and diagrams, and then pasting it under:

- The same parent Package
- One or more other Packages in the same model or project, or
- One or more other Packages in another model or project

You would tend to use this procedure for copying sections of a model within the project rather than reproducing an entire model or project, although copying these larger structures is equally feasible.

Duplicate a Package

Action	Detail
Copy the Package	In the Browser window, right-click on the Package and select the 'Copy / Paste Copy to Clipboard Full Structure for Duplication' option (or click on the Package and press Ctrl+Shift+C). The 'Copy selected Package to Clipboard'

	<p>dialog briefly displays until the copy operation completes.</p>
Paste the Package	<p>In the Browser window, right-click on the target Package into which to paste the copied Package, and select the 'Copy / Paste Paste Package from Clipboard' context menu option (or click on the Package and press Ctrl+V).</p> <p>The 'Paste Package from Clipboard' dialog briefly displays until the paste operation completes.</p> <p>In the Browser window, the target Package is expanded to show the pasted Package; if you are pasting the Package within the same model as the copied source, the source parent Package is also collapsed. Note that any Version Control settings on the initial Package are removed from the pasted version.</p> <p>If the target Package already contains:</p> <ul style="list-style-type: none">• A Package with the same name as the pasted Package, the pasted Package name has the suffix - Copy• A Package with the same name as the pasted Package including the - Copy suffix, the suffix becomes - Copy1 (or - Copy2, - Copy3 and so on, as copies of the Package accumulate in the target

	<p>parent Package)</p> <p>You can keep the same Package name as the source, or you can rename the Package by either:</p> <ul style="list-style-type: none">• Clicking twice on it and editing the name in the Browser window, or• Double-clicking on it and editing the name in the 'Properties' dialog
--	--

Notes

- You cannot paste a Package into a parent Package that is locked by another user or that is checked in; the 'Paste...' option is grayed out in the context menu
- This procedure is effectively the same as exporting and importing the Package Native/XMI file, with the 'Strip GUIDs' checkbox selected
- The paste operation can be a single transaction or a series of transactions to paste each data item separately, depending on the setting of the 'Import using single transaction' checkbox in the 'XML Specifications' page of the 'Preferences' dialog
- You can also move a Package to a different part of the model, in the same way as moving an element

Delete a Package

If you do not want to keep a particular Package in the model, it is very simple to remove it.

Access

Context Menu	Right-click on Package Delete '<package name>'
Keyboard Shortcuts	Ctrl+Del

Notes

- Deleting a Package also deletes all contents of the Package, including sub-Packages and elements; make very sure that you really want to do this before proceeding
- In a multi-user environment, other users do not see the change until they reload their project

Model Diagrams

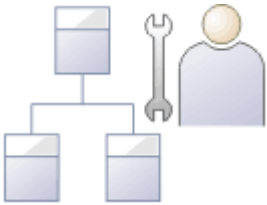

Diagrams are one of the most expressive views of the repository. They show a number of elements connected to each other by relationships, creating a narrative that describes a part of the repository in a visual language. Quite commonly the elements in a diagram exist in the same Package in the Browser window; however, the most expressive diagrams typically contain elements of different types from different Packages.

Creating a diagram is one of the most common ways for a modeler to add elements or relationships to the repository. As new elements are dropped onto the diagram canvas from the Toolbox, they are added to the same Package (or element) that contains the diagram. These same elements can participate in other diagrams; in fact, the more diagrams the elements appear in, the richer the model.

Diagrams are displayed in the Browser window as a child of either a Package or another element. While they often reside in the same Package (or element) as the elements they contain, they can be freely moved around the Browser window to any location.

Like learners of natural languages, newcomers to modeling often create basic diagrams that lack expression, but with a little practice and some time spent examining the diagrams

of experienced modelers their diagrams will soon become rich and expressive.

Enterprise Architect supports a wide range of modeling languages, each of which has a set of diagrams; these include the UML, BPMN, SysML and many other languages and technologies.

Developing Diagrams

As you create your diagrams and add modeling elements to them, you can use a number of helpful facilities to add extra meaning and expression, such as:

- Partition the diagram, whatever the type, either vertically into columns or horizontally into rows, using Swimlanes
- Partition the diagram into a grid of cells, using a Swimlanes Matrix
- Create a Kanban diagram, sectioned and color-coded to organize the elements' project management properties
- Add Legend elements, which both provide and can automatically apply a key to the colors and styles you have used for the modeling elements on the diagram
- Depict the more elements on the diagram as the objects that they represent, using graphical images from the Image Manager
- Automatically apply one of a range of layout formats to the diagram

Notes

- If the diagram display is too small to read comfortably, click on the diagram, press and hold Ctrl and use the mouse wheel to temporarily expand or reduce the display magnification
- Diagrams can be the subjects of informal discussions and formal reviews; to add a diagram to a:
 - Discussion, simply click on it when the Discuss & Review window is open
 - Review, encapsulate it in a Navigation Cell on the Review diagram

Diagram View

If you have created diagrams in the Browser window, you can select to open them and then add elements and connectors to them within the Diagram View. This is the main workspace for developing the structure of your model components, dragging new objects onto the diagram from the Diagram Toolbox and existing objects from the Browser window. You can also add elements and connectors using the Quick Linker and other context menus within the Diagram View, and move, format and edit them.

Most work on elements and connectors is carried out in the Diagram View, so understanding how it works and how to manipulate elements is essential. You can use the EAExample project supplied with the system, or your own 'sandpit' models, to explore the capabilities and behavior of the Diagram View.

Access

Browser Window	<ul style="list-style-type: none">• Double-click on the diagram name, or• Select the diagram node and press the Enter key
----------------	--

Diagram sections

Section	Description
Caption Bar	<p>Across the top of a diagram is the diagram caption bar, which includes:</p> <ul style="list-style-type: none"> • A horizontal 'chevron' icon to display or hide the Diagram Toolbox docked on the left of the Diagram View, from which point you can drag it and dock it elsewhere; if you then hide the toolbox and show it again, it is placed back on the left of the Diagram View <p>Whichever diagram you have displayed, the Toolbox pages are appropriate to that diagram type</p> <ul style="list-style-type: none"> • Icon and text label for the diagram type • Diagram name • A second 'chevron' icon that toggles display of the inline specification panel for the diagram (see the later table entry on this view). • A drop-down arrow that lists the currently-open diagrams and views; click on: <ul style="list-style-type: none"> - A diagram or view name to switch to that diagram or view - Options to redisplay the hidden Start Page and (if defined) the Model Default

	<p>diagram, Model Default Kanban chart, User Default diagram or User Default</p> <p>Kanban chart</p> <ul style="list-style-type: none"> • The window 'close cross'; click on this to close the displayed diagram
<p>The Diagram Toolbar</p>	<p>This is the fixed Toolbar that displays at the top of every diagram if the 'Show Diagram Toolbar' option is selected on the 'Window Behavior' page of the Preferences window. It provides a wide range of options to help you lay out, format, view and filter the contents of diagram.</p> 
<p>Diagram View</p>	<p>The larger area underneath the Caption bar is the work area within which you can create and view the diagram structures. The borders of the printable diagram page are represented by pale broken lines; structures created beyond these borders will print on separate pages.</p> <p>The Diagram View area is also where the diagram and object context menus operate, and where the representation of the model structure can be changed to a Specification Manager view, Relation</p>

	Matrix View, Construct View (Resource Management), Gantt chart or Diagram List format.
Inline Specification Panel	<p>This panel presents a textual specification of each element in the diagram, the elements being listed initially in alphabetical order. This helps you to visualize and read, at the same time, the section of the model represented by the diagram, giving a comprehensive view of the model. It is also useful when you are creating Package structures using templates (with the Model Builder); you can quickly update your elements without having to open another docked window. As you click on an element in either the diagram or panel, it is also selected in the other.</p> <p>The panel does not display separately from the diagram; you toggle it on or off for each diagram individually.</p> <p>You can double-click on the element name or notes in the panel and edit the text directly. You can also right-click on an element and select from these context menu options:</p> <ul style="list-style-type: none">• Properties - to display the 'Properties' dialog for the element

- Edit Selection - to immediately put the element name in edit mode, to change it
- Edit Notes - to immediately put the element notes in edit mode, to change them
- Find in Project Browser - to locate and highlight the selected element in the Browser window
- Properties Window - to display the Properties window for the element
- Extended Properties - also displays the Properties window; view the 'Tags' tab and/or the <<stereotype>> segment of the 'Element' tab
- Apply Sort - to change the order in which the elements are listed, to the sequence of elements either left to right across the diagram, or top to bottom down the diagram
- Reload View - to refresh the display in the Inline Specification View

Notes

- Diagrams can contain hyperlinks to other diagrams, which are opened when you click on the links

- It is possible to open several diagrams at once, but within the Diagram View you can only view one at a time
- You can view and work on several diagrams at once by making each tab containing a diagram into a floating window, using the tab context menu; the docked Toolbar remains on the left of the Diagram View frame
- You can also work on elements using the Diagram List
- Additional information on the diagram, or a selected element within the diagram, is displayed in the system Status bar

Working In Diagrams

Enterprise Architect provides a wide range of facilities for creating, editing and managing the diagrams that represent aspects of your models.

Facilities

Facility
Create a UML diagram, Extended diagram or MDG Technology diagram in your model, through the Browser window.
Set or change various properties of a diagram, such as the diagram name, through the diagram 'Properties' dialog. Some properties influence the display of the diagram and some are logical attributes that appear in the documentation.
Display a Diagram Properties Note on the diagram. A Diagram Properties Note is a simple fixed-text box containing the diagram name, author, version, creation date and modification date. You can move this text box to any point on the diagram.
Add new elements and connectors to a diagram using the Diagram Toolbox pages specific to the diagram type,

or other Toolbox pages as you need.

Add new elements and connectors to a diagram using the **Quick Linker** facilities.

Drop existing elements from the Browser window into the diagram.

Drop elements copied from a diagram into another diagram.

Change the Z-order of selected elements on the diagram, to define which elements might lie over or underneath other elements.

You can convert a tabbed diagram in the Diagram View into a floating diagram. In this case, you can move or copy elements between that diagram and another floating diagram or tabbed diagram.

Move sections of the diagram independent of the rest of the diagram.

Automatically resize the selected elements on the diagram to the default size for the element type, or as close to it as the element contents allow.

Identify which other elements are related to a selected element on the diagram and, if necessary, add one or

more of those other elements to the diagram.

Generate virtual images of connector end elements, to simplify complex and extended relationships on a diagram.

Control the display of labels around elements and connectors on the diagram.

More precisely represent realized interfaces of a Class on your diagram.

Expand the contents of a Package element within a diagram.

Manage the visibility of a range of element features on the diagram.

Undo and redo the immediately previous changes to the diagram.

Pan across and down a large diagram, and zoom into or out of the diagram display.

Select and move elements on the diagram using keyboard keys ('hotkeys').

Switch between the currently-open diagrams and views in the Diagram View.

Change a diagram from one type (such as Class) to another (such as Data Modeling).

Flag a selected diagram as the Model Default diagram for your project, or your User Default diagram.

Scale down the Printable image of the diagram to fit the size of paper it is being printed on.

Set the scrollable/printable area of the diagram display area.

Present a set of diagrams in a Model Views slideshow.

Lock the current diagram so that it cannot be updated.

Create a duplicate copy of an existing diagram.

Save an image of the diagram to a file, in a range of graphic file formats.

Copy an image of the diagram to the MS Windows clipboard.

Delete one or more diagrams from the model.

Notes



- In the Corporate, Unified and Ultimate Editions of Enterprise Architect, if security is enabled you must have 'Update Element' permission to update or delete items on a diagram, and 'Manage Diagram' permission to create, copy or delete diagrams

Add New Diagrams

Enterprise Architect provides a number of ways in which to create a new UML diagram, Extended diagram or MDG Technology diagram in your model. The principal method is to select the Package or element under which to create the diagram and select a menu option to add it, as explained here.

Add a New Diagram to the Model

Step	Action
1	In the Browser window, click on the Package or element under which to place the diagram.
2	Either: <ul style="list-style-type: none"> • In the Browser window header bar, click on the  button, or • Right-click on the object to open the context menu and select the 'New Diagram' (Package) or 'Add New Diagram' (element) option, or • Press the Insert key and select the 'New Diagram' menu option The 'Diagram Builder' dialog displays.
	The 'Package' field defaults to the name of the

3	<p>Package selected in the Browser window or, if the parent is an element, the name of the Package containing that element.</p> <p>If you are adding a diagram directly to a Package and notice that it is not the correct Package, click on the  button and browse for the correct Package. (The  button is disabled when you are creating a diagram under an element, and the 'Parent' field shows the name of the element under which you are creating the diagram.)</p>
4	<p>The 'Diagram' field defaults to the name of the selected Package or element; if necessary, type a different name for the new diagram.</p>
5	<p>Click on the <perspective name> button underneath the 'Type' header, and select the Perspective Group and Perspective most appropriate to the area you are working in. If you want to examine diagram types across the model from any Perspective, click on the button and select 'All'.</p> <p>The panel underneath the header displays a list of diagram groups; click on the required group.</p> <p>When you initially open the 'New Diagram' dialog, the Perspective name on the button is the Perspective shown in the  <perspective name> icon at the top right of the application screen. Changing the Perspective in the 'New Diagram' dialog does not change the 'global' perspective on the icon. If you</p>

	want to re-set the 'New Diagram' dialog Perspective to the global Perspective, simply click on the <perspective name> button and select 'Active'.
6	<p>In the 'Diagram Types' panel, click on the type of diagram to create and, where listed, the view to create. The view is a refinement of the type to further tailor the diagram to a purpose, and restricts the elements and connectors provided in the Toolbox pages to those appropriate to the purpose.</p> <p>A description of the selected diagram type displays in the field underneath this pane.</p>
7	Click on the 'Create Diagram' button to create your new diagram.

Notes

- In the Corporate, Unified and Ultimate Editions of Enterprise Architect, if security is enabled you must have 'Manage Diagrams' permission to create new diagrams
- The diagram type determines the default Toolbox pages associated with the diagram and whether the diagram can be moved as a child of another element in the Browser window (for example, a Sequence diagram under a Use Case)

Insert Diagram Properties Note

On a diagram, it is possible to display a customized text box called the Diagram Properties Note, which automatically shows the diagram properties:

- Name
- Author
- Version
- Creation date and
- Modification date

You can move this Note around the diagram and change its appearance, and you can create several instances of it to, for example, put the property information on each page of the diagram. You cannot change the content.

Access

Ribbon	Layout > Diagram > Appearance > Show Diagram Property Note
Other	Drag the 'Diagram Notes' icon from the 'Common' page of the Toolbox onto the diagram Click on the 'Diagram Properties Note' icon in the UML Elements toolbar and click on the diagram

Notes

- The Diagram Properties Note is not the same as the Diagram Details Note, which displays if the 'Show Diagram Details' checkbox is selected on the 'Properties' dialog for the diagram; this always displays in the top left corner of the diagram - you cannot move it, change its appearance or have more than one instance of it on the diagram

Drop Package From Browser Window

You can drag a Package element from the Browser window and drop it onto the current diagram, to show a representation of the Package in one of several formats. You select the format from a short context menu. This is a useful feature to help organize the display, reporting and documentation of models.

Access

Other	Drag existing Package(s) from the Browser window onto the diagram.
-------	--

Select Drop options

Option	Action
Package element	Select this option to generate a Package element on the diagram, containing a list of the Package contents. In this illustration, note the child Actor and Use Case icons.

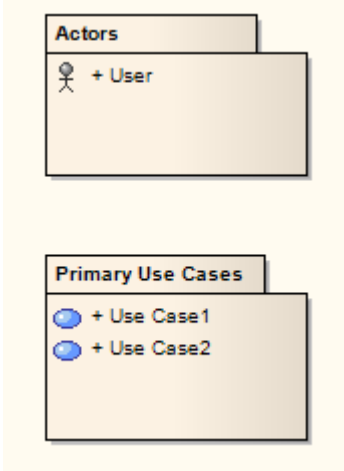
	 <p>You can hide the contents of the element if necessary. See the <i>Show or Hide Package Contents</i> Help topic. The diagram element is a simple link to the Package in the Browser window; any changes to the Package are reflected in all diagrams in which it is shown.</p>
<p>Report Specification linked to package</p>	<p>Select this option to generate a Report Specification Artifact element linked to the Package, which immediately opens to the 'Generate Documentation' dialog on which you enter the parameters for generating the report. Thereafter, you can simply double-click on the element and click on the Generate button to generate the same report on the Package, whenever necessary. The report can be read as a Linked Document on the element.</p>

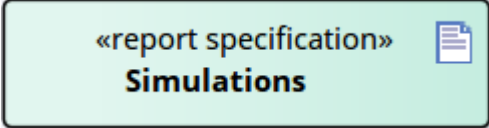
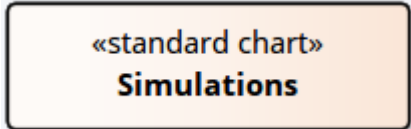
	
<p>Graph based on Package contents</p>	<p>Select this option to create a Standard Chart Artifact. The Standard Chart 'Properties' dialog displays at the 'Chart Detail' pages, on which you can configure the generation of a Pie Chart or Bar Chart to graphically represent an aspect of the Package content.</p> 
<p>Matrix profile</p>	<p>Select this option to create a Matrix Specification Artifact. The 'Matrix Specification' dialog displays.</p>
<p>Package as List</p>	<p>Drop the Package as a Model View chart element that lists the elements within the Package and shows the type (by icon), name, Scope, Status and Author of each element.</p>

Notes

- If you drop several Packages onto a diagram together, the 'drop type' context menu displays once; the option you

select applies to all Packages you have dropped on the diagram

Show or Hide Package Contents

If you have Package elements displayed in an open diagram, you can toggle between showing the Package contents within the elements, or leaving them clear.

Access

Ribbon	Design > Diagram > Manage > Properties > Elements
Context Menu	Browser window or open diagram Right-click on diagram Properties > Elements

Steps

Step	Instruction
1	Select the 'Package Contents' checkbox to list the content of each Package within its element. Clear the 'Package Contents' checkbox to hide the content of each Package within its element.

2	Click on the OK button.
---	-------------------------

Drop Elements from Browser Window

As well as creating new elements in the current diagram, you can drag existing elements (individually or as a group) from the Browser window into the diagram. To select multiple elements, click on the element names in the Browser window while pressing and holding:

- Ctrl to add single items to the selection of multiple elements, or
- Shift to select all the elements between the first and last selected items

When you drag an element onto a diagram from the Browser window, the system response depends on whether you are dragging a Package element or any other type of element. For information on dragging a Package element onto a diagram, see the *Drop Package From Browser Window* topic.

It is not possible to duplicate an element on the *same* diagram, but you can generate representations of the element at the ends of connectors, called virtual connector ends. See the *Virtual Connector Ends - Represent One Element Several Times on a Diagram* Help topic.

Access

Other	Drag existing element(s) from the Browser window onto the diagram
-------	---

	(If the 'Drop <element> from Project Browser' dialog does not display, press Ctrl while dragging the elements)
--	--

Select Paste options

Option	Action
Drop as	<p>Click on the drop-down arrow and select one of the drop types:</p> <ul style="list-style-type: none"> • Link - Drop the element as a simple link: in this case the one element is represented in the Browser window and in any diagram to which it has been added; changes to the element are reflected in all diagrams in which it is shown • Lifeline - (On Sequence diagrams) Drop a copy of the element as a separate Lifeline element, classified by the original element • Instance - (On diagrams other than Sequence) Drop a copy of the element as a separate instance of the original element, classified by the original element • Invocation - Drop a copy of a

StateMachine or Activity element as an invocation of the source element; the resulting element is a State object or Action - respectively - with the source element as its classifier

- Property - Drop a copy of the element as a separate Object instance
- Attribute - (Available when dragging a classifier onto an element that supports attributes) Create a new attribute classified by the dragged classifier; the attribute is automatically selected in in-place editing so that you can add the attribute name
- Child - Drop the element as a child of the copied element - that is, as a new element with a Generalization connector back to the copied element; this is very useful when you have a Class library or framework from which you inherit new forms - for example, you can drop a Hashtable as 'MyHashtable', which automatically becomes a child of the original Hashtable

Used with the 'Override Parent Operations' feature, this is a quick way to create new structures based on

	frameworks such as the Java SDK and the .NET SDK
Name	If the dropped element is being added as a new element (that is, a Lifeline, Instance, Child, or Property), this field is active; type a name for the new element.
Structural Elements	<p>If the original element has any structural elements (for example, Ports and Parts) this field contains the value 'Select'. Either:</p> <ul style="list-style-type: none"> • Leave this value as is, so that when you click on the OK button the Features window displays, from which you can select the child elements to reproduce with the pasted element (on the 'Parts / Properties' tab, 'Interaction Points' tab or 'Connection Points' tab, depending on the element type) or • Click on the drop-down arrow and select: <ul style="list-style-type: none"> - 'None' to not reproduce any child elements - 'All' to reproduce all child elements on the original element, or - '<diagram name>' to reproduce the configuration of child elements on an instance of the

	<p>original element on another diagram (if there are any other instances); there can be more than one diagram name, if the original element is found on several diagrams</p> <p>The resulting Object element is created large enough to display the selected child elements laid out neatly within the Object border.</p> <p>(If the element has no structural elements, the field contains the text 'No Embedded Elements'.)</p>
Copy Connectors	<p>This checkbox is enabled when you select to drop the copied element as an Instance, Property or Invocation.</p> <p>Select the checkbox to reproduce on the diagram any connectors between the original element and any other elements that have also been dropped into this diagram, as connectors between the instances.</p>
Select for all	<p>(If dragging multiple elements onto the diagram at once.)</p> <p>Select the checkbox to apply the dialog settings to all multiple-selected elements being dragged onto the diagram, and to</p>

	<p>add the elements together.</p> <p>Leave the checkbox unselected to add the elements to the diagram one at a time, with the opportunity to change the dialog settings for each element.</p>
Save selection as default	<p>Select this checkbox to make the current settings on this dialog the default for all drag and drop operations from the Browser window.</p> <p>This option also deselects the 'Auto Instance' checkbox on the 'Diagram > Behavior' page of the 'Preferences' dialog. The automatic drop operation becomes whatever you have set on the 'Drop ... from Project Browser' dialog, and is not overridden by the drop-as-Instance imposed by the 'Auto Instance' checkbox.</p> <p>The default setting you apply on Sequence diagrams is separate from the default for other types of diagram. Therefore, you can set the default to 'Lifeline' (if you prefer) and this does not affect or get changed by the default you might set for other types of diagram.</p>
Hold Ctrl to Show this dialog	<p>Select this checkbox to display this dialog for drag and drop operations only if you press and hold Ctrl as you drag the</p>

	<p>element onto the diagram.</p> <p>If you select this option, you can drag elements from the Browser window without displaying the dialog; the paste operation complies with whatever settings you used the last time you opened the dialog. To change these settings, hold Ctrl as you drag an element, and edit the field values on the dialog.</p>
OK	<p>Click on this button to complete the drop operation and close the dialog.</p>
Cancel	<p>Click on this button to cancel the drop operation and close the dialog.</p> <p>If you have selected multiple elements, the first-selected element is not dropped, but the remainder are.</p>
Cancel All	<p>(If dragging multiple elements onto the diagram at once.)</p> <p>Click on this button to cancel the insertion of all the multiple-selected elements being dragged onto the diagram.</p>

Notes

- Not all drop options apply to all element types; for many types, the only option available is 'Link'
- When an element dragged from the Browser window is dropped into the diagram, its default style and size is applied rather than any alternative styles and sizes used for instances of the element in other diagrams
- If an element is dropped onto a diagram as a Link, any attached Boundary, Note, Text or Constraint elements are duplicated on the diagram
- When using the 'Drop as - Instance' option, if the Instance is the same element type as the Classifier, then any stereotype that has been applied to the Classifier will be propagated to the Instance also

Drop Elements onto Connectors

A number of scenarios are supported, that allow you to drag elements, either existing elements from the Browser window or new elements from the diagram toolbox, and drop them onto connectors on a diagram.

In the general case, the dragged element is inserted into the middle of the connector, provided that the result is UML compliant. There is also a number of specific scenarios that are detailed in the table below.

Access

Other	<p>Drag a new element from the diagram toolbox onto a connector on the diagram</p> <p>Drag an existing element from Browser window onto a connector on the diagram</p> <p>Drag an existing element already on the diagram onto a connector on the diagram</p>
-------	---

Scenarios

Action	Result
Drag and	The Classifier is set as a Conveyed Item

drop a Classifier onto an ItemFlow connector	on the ItemFlow.
Drag a Classifier onto a Connector in SysML Internal Block Diagrams	An ItemFlow connector is created, with the Classifier used as a Conveyed Item (user is prompted to specify direction)
Drag a Signal onto a Message in a Sequence diagram	Apply the Signal as a Signal of the message
Drag a Trigger onto a Transition in a StateMachine diagram	Apply the Trigger as a Trigger of the flow
Drag an	Insert the element at the mid-point of the

Element on a Connector in a Diagram (General case)	connector
--	-----------

Drop Elements onto Other Elements

A number of scenarios are supported, that allow you to drag elements, either existing elements from the Browser window or new elements from the diagram toolbox, and drop them onto other elements on a diagram.

In most cases, the dragged element will become an embedded child element of the target element, however, there are some specific scenarios that are detailed in the table below.

Access

Other	<p>Drag a new element from the diagram toolbox onto an element on the diagram</p> <p>Drag an existing element from the Browser window onto an element on the diagram</p>
-------	--

Scenarios

Action	Result
Drag an Activity onto	Apply the Activity as an "entry/do/exit" behavior of the State (user is prompted to

a State in a StateMachine diagram	specify which behavior)
Drag a Signal onto a SendSignal Action	Apply the Signal Note: Only dragging of existing Signals from the Browser window is supported.
Drag a Signal onto an AcceptEvent Action	(Create a new Trigger and) Apply the Signal Note: Only dragging of existing Signals from the Browser window is supported.

Z Order Elements

Z Order refers to the sequence in which elements are layered through the depth of the diagram; each element on the diagram has a specific Z-order number that - when elements overlap - determines which elements the selected element displays in front of, and which behind. The first element added to a diagram will get a Z Order value of 1 and will appear behind any overlapping elements with a higher Z Order value.

You can move an element:

- One place further back, deeper into the diagram
- One place further forward, towards the front of the diagram
- To the bottom of the diagram (deeper in than all other elements in the diagram)
- To the top of the diagram (further forward than all other elements in the diagram)

You have options to change the Z order of a single element approximately in relation to the rest of the diagram; you can also select the 'Configure Z Order' option from the diagram context menu, to review and adjust the Z Order of each element on the diagram precisely relative to every other element

Access

--	--

Ribbon	Layout > Alignment > choose either 'Bring to Front' icon (top of the Z order) or 'Send to Back' icon (bottom of the Z order) Design > Diagram > Options > Configure Z Order
Context Menu	Right-click on element in a diagram Z-Order : Select the appropriate option to reposition the selected element.



Notes



- On a diagram, you can move the focus from element to element according to Z Order, by pressing Shift+Tab; each time you press these keys, the element with the next-lowest Z Order number is selected

Move Elements Within Diagrams

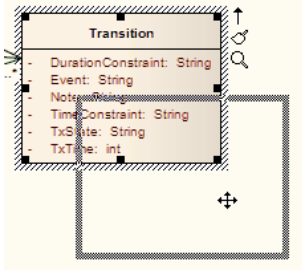
As you add new elements to a diagram, you might want to move the existing elements to create more space, make a structure more apparent, or create a nesting relationship between two elements. There are several ways in which you can move the elements within the diagram.

Move Elements

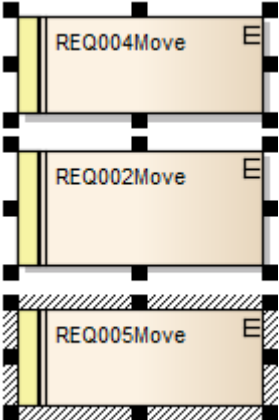
Image	Action
<p>Change Position</p> 	<p>Select an element or group of elements in the diagram, then:</p> <ul style="list-style-type: none"> • Use the mouse to drag the element or group of elements to the required position (the cursor switches to the four-arrow icon as shown) • Hold down Shift and press the appropriate arrow keys to move the element or group of elements by small increments in the arrow direction <p>If you are moving a single element and you have selected the 'Layout > Alignment >  > Smart Placement' and 'Show smart placement guide' options, as you move the element colored lines will display around the element. These</p>

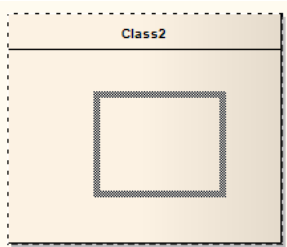
	<p>indicate the positions of the edges and edge-centers as they align with an adjacent element or connector. Note that the objects must be contemporary - not at different hierarchical levels and not in different partitions of the diagram.</p>
<p>Align Elements</p> 	<p>Select a group of elements in the diagram and align them on the last-selected element using:</p> <ul style="list-style-type: none"> • The 'Align...' options in the right-click context menu or • The Alignment buttons on the Diagram toolbar 
<p>Confirm Possible Nest Elements</p> 	<p>If you want to nest one element within another, you can drag that element onto the 'nest' element; the nesting element is then always encapsulated by the nest and moved within the nest.</p> <p>Not all element combinations are valid. For example:</p> <ul style="list-style-type: none"> • Drag a Signal element over a Class; because a Class element can nest a Signal, the Signal element is encapsulated • Drag a Class element over a Signal

	<p>element; because a Signal cannot nest a Class, the Class element is not encapsulated</p> <p>To confirm that the proposed nest element is able to accept the selected nesting element, observe the nest element border as you drag the nesting element over it:</p> <ul style="list-style-type: none">• If the nest element can accept the selected element, the nest element border changes to a dashed line• If the border does not change, the selected element cannot be encapsulated within the nest element
--	--

Notes (on Adding nesting element to nest)

- The 'Support for Composite Objects' checkbox must be selected on the 'Objects' page of the 'Preferences' dialog (select the 'Start > Appearance > Preferences > Preferences' ribbon option and click on the 'Objects' page); if this option is not selected, the dashed border does not show and the nesting element cannot be embedded on the nest element in the diagram
- Both elements must already exist on the diagram; the nest element border does not change if you drag a potential nesting element over it from the Toolbox or Browser

window

- The nesting element must be dragged right over the nest element, so that its borders are completely within the nest element borders
- The Z-order of the nesting element is automatically adjusted so that it is not hidden by the nest element
- When you embed a nesting element on its nest element, the nesting element becomes part of the nest element hierarchy in the Browser window; if you drag the nesting element out of the nest element, the nesting element becomes independent and is no longer embedded in the nest element hierarchy

Element Alignment Facilities

There are two distinct element alignment facilities provided by Enterprise Architect, known as 'Standard Grid' and 'Smart Placement'. These facilities assist in aligning, sizing and spacing elements on your diagrams, so you can quickly and easily produce aesthetically pleasing layouts.

Click on the 'layout grid' icon , to display a drop-down menu for enabling the Standard Grid or Smart Placement facilities, and for setting various options relating to those facilities. The options are described below.

You cannot operate both Standard Grid and Smart Placement at the same time. You can choose one, or the other, or neither.

Standard Grid Options

The Standard Grid facility is designed to enhance the precision and alignment of elements in diagrams or design interfaces. When enabled, this facility ensures that when positioning elements on the diagram, their edges automatically 'snap' to the nearest grid point as they are moved or resized. This helps maintain consistent spacing and alignment, making it easier to organize elements neatly without having to manually adjust their positions.

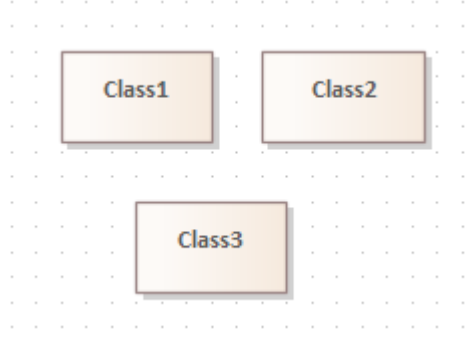
Option	Description
<p>Enable</p>	<p>Select this checkbox to Enable the 'Snap to Grid' facility. (Enabling Standard Grid will disable Smart Placement.)</p>
<p>Show Grid</p>	<p>Select this checkbox to display a grid of light gray dots over the background of the diagram.</p> <p>Note: It is not necessary to display the grid dots in order to use the Snap to Grid facility.</p>  <p>The diagram illustrates the 'Show Grid' option. It features a light gray dotted grid background. Three rectangular boxes, labeled 'Class1', 'Class2', and 'Class3', are positioned on the grid. 'Class1' and 'Class2' are aligned horizontally at the top, while 'Class3' is centered below them. The boxes are perfectly aligned with the grid lines, demonstrating the 'Snap to Grid' functionality.</p>

Smart Placement Options

When enabled, the Smart Placement facility causes edges or mid-points of elements that are being moved or resized, to 'snap to position' to align with the edges or mid-points of nearby elements. It can also 'snap to position' such that element sizes and spacing are equal.

When the option to display guidelines is enabled, as elements are moved or resized, lines are drawn on the diagram indicating which 'snapping feature' will take effect.

Option	Description
Enable	Select this checkbox to Enable the Smart Placement facility. (Enabling Smart Placement will disable Standard Grid.)
Multi Select	Select this checkbox to enable Smart Placement of the 'bounding rectangle' that encloses a group of selected elements. The bounding rectangle will snap to the edges and centerlines of nearby non-selected elements, as the selected elements are moved across the diagram.

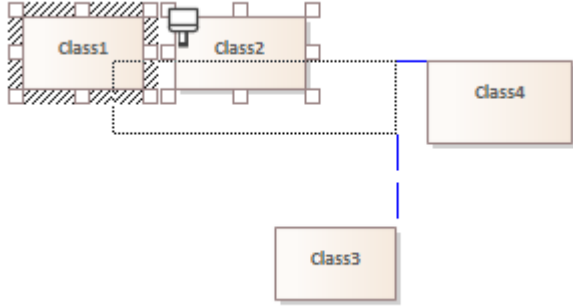
	 <p>Resizing is not supported for multiple selection, so the Same Size option will have no effect when multiple objects are selected.</p>
<p>Show Guides</p>	<p>Select this checkbox to enable the display of Smart Placement guidelines on the diagram as elements are being moved or resized.</p> <p>Guidelines will only be displayed between objects that are on the same hierarchical level and within the same partition of the diagram.</p> <p>Note: It is not necessary to have 'Show Guides' enabled for the Smart Placement facility to take effect.</p>
<p>Element Bounds</p>	<p>Select this checkbox to enable snapping of the position of an element being moved, to align with the position of other nearby objects. When moving an object, its position will 'snap', such that horizontal edges (top or bottom) and</p>

centerlines, will align with horizontal edges and centerlines of other objects. Similarly, vertical edges and centerlines will also snap into position. If Show Guides is enabled, lines are displayed indicating which edges or centerlines are being matched.

You may wish to deselect this option, to prevent too many guidelines from displaying at once, when you want to simply space out elements with the Relative Spacing option or adjust sizes with Same Size option.

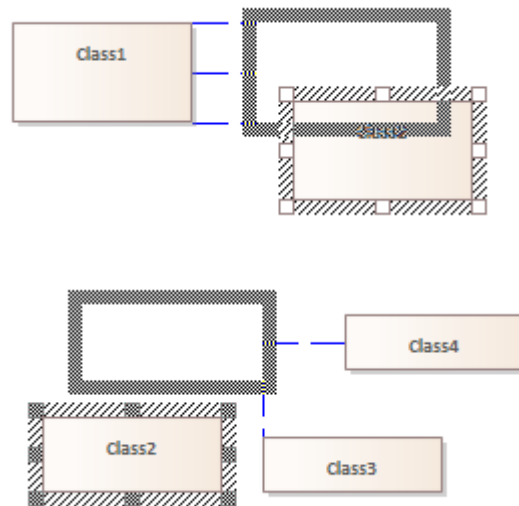

Same Size

Select this checkbox to enable snapping to the same size as other objects within the visible area. When resizing an element, the moving edge will snap into place when it reaches the same width, height or both of another object. If Show

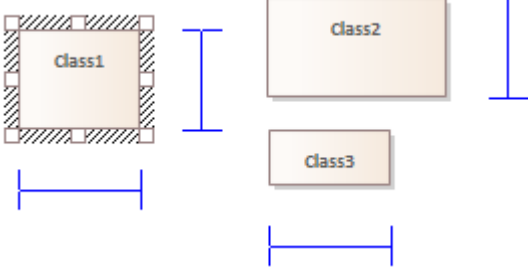
	<p>Guides is enabled, lines are displayed indicating which dimensions on which objects are being matched.</p>  <p>Resizing is not supported for multiple selection, so the Same Size option will have no effect when multiple objects are selected.</p>
<p>Relative Spacing</p>	<p>Select this checkbox to enable snapping of the position of an element being moved, when its spacing to a nearby object, matches the spacing between other objects in the visible area. If Show Guides is enabled, lines are displayed indicating which object spacing is being matched.</p> <p>(Eg: when moving Class3, it will snap into position when Class3 is at the same distance from Class1 as Class1 is from Class2).</p>

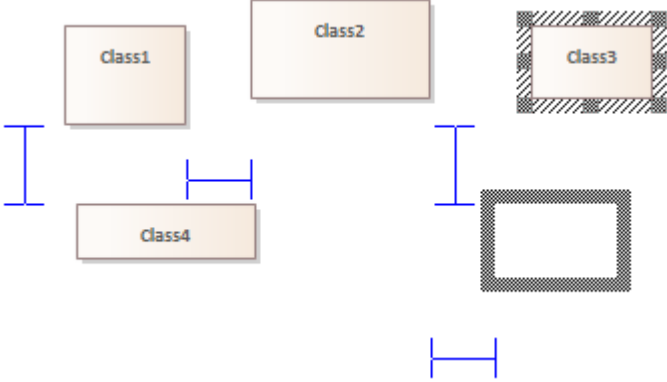
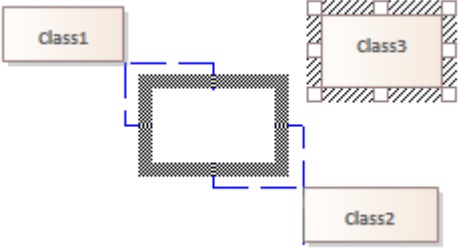
	
<p>Mid Points</p>	<p>Select this checkbox to enable snapping of the position of an element being moved, when its position is midway, either horizontally or vertically, between two other objects on the diagram, provided the positions do not overlap. If Show Guides is enabled, lines are displayed indicating that the object being moved is midway between two other objects.</p> <p>(Eg: Moving ClassA between the objects ClassB and ClassC will cause it to snap to a point that is midway between both of those objects as long as they aren't overlapped and there's enough space for ClassA to fit between them).</p> 

Move Elements In Diagram Sections

As you build up a diagram, you might find that you have to move all elements within a part of the diagram up, down or to one side. You can do this in a number of ways.

Fine Movement

You can nudge the position of a single element or a selected group of elements in 1 pixel increments. Press Shift and then the arrow key for the direction of movement (Right, Left, Up or Down).

Drag Selected Groups of Elements

If you want to reposition a certain group of elements, hold down the left mouse button and drag the cursor over the elements to move (creating an outline around the elements), then click on an element within the outline and drag the group as required.

Move Sections of the Diagram

You might need to create some space in the diagram. Selecting and moving even groups of elements around in a large diagram can be difficult, so it is possible to just move everything beyond a certain point further away from the rest of the diagram, without having to select the elements you are moving. To do this:

- Select the 'Layout > Helpers > Sweeper' ribbon option, click on the diagram at an appropriate point and drag the cursor to move everything beyond the cursor in the direction of the movement

or

- Hold down Alt, click on the diagram at an appropriate point and drag the cursor to move everything beyond the cursor in the direction of the movement

Depending on whether you drag the cursor vertically, horizontally or diagonally, either a horizontal or vertical line or both displays on the diagram just behind the cursor. If you are moving the cursor left, everything to the left of the line moves with the cursor. If you move the cursor up, everything above the line moves upwards. If you move the cursor diagonally, everything within the quadrant formed by the lines moves. For example, if you move the cursor left and down, everything below and left of the cursor is moved.

Move Elements Between Diagrams

If an element is present in one diagram but actually belongs in another, you can simply move the element from the first diagram into the second. You can also cut multiple elements from one diagram and paste them into another. When you cut elements from a diagram, the elements are held on the clipboard but are not cleared from the source diagram until they are specifically pasted into the target diagram. A moved element is not affected in any other way.

Access

Open the diagrams:

- Containing the element(s) to be moved, and
- Into which the elements(s) will be moved

Keyboard Shortcuts	<p>With the element selected in the source diagram:</p> <ul style="list-style-type: none"> • Ctrl+X <p>With the cursor in the target diagram:</p> <ul style="list-style-type: none"> • Ctrl+V or Shift+Insert
Other	<p>Display the 'Default Tools' Toolbar (Explore > Portals > Show Toolbar > Default Tools) and:</p> <ul style="list-style-type: none"> • On the source diagram, click on the element to be moved and on the 

	<p>icon in the Toolbar</p> <ul style="list-style-type: none">• Click on the target diagram and on the  icon in the Toolbar
--	---

Notes

- By selecting more than one element at a time, you can move multiple elements in the same operation

Copy Elements Between Diagrams

As you develop a diagram, it is not uncommon to find that some of the elements and structures of elements could also be used on another diagram. You can copy those elements and structures onto another diagram as a new set of elements without losing the element composition or the organization of the structure. In doing this, you can change any of the element names within the structure and preserve the relative nesting of the elements.

Access

Ribbon	<p>With element(s) selected in source diagram:</p> <ul style="list-style-type: none">• Layout > Diagram > Select > Copy Selected Elements <p>With input focus on target diagram:</p> <ul style="list-style-type: none">• Layout > Diagram > Select > Paste as Reference or• Layout > Diagram > Select > Paste as New
Keyboard Shortcuts	<p>With element(s) selected in source diagram:</p> <ul style="list-style-type: none">• Ctrl+C <p>With input focus on target diagram:</p>

- | | |
|--|---|
| | <ul style="list-style-type: none"> • Shift+Insert (Paste as Link) • Ctrl+Shift+V (Paste as New) |
|--|---|

Paste Element(s) as Reference

If you select to paste the copied elements as references (or links) to the source element(s), the elements are added to the diagram as instances of the source element(s) on the target diagram, with any connectors between them. Notes, Text, Boundary and Constraint elements attached to the pasted element are duplicated on the target diagram.

Complete the Paste Element(s) as New Dialog

If you select to paste the copied elements as new elements, the 'Paste Element(s) as New' dialog displays.

Option	Action
Original Element Name	Each element name defaults to selected, to be inserted in the target diagram. If you want to omit an element from the copied structure, clear the checkbox against it.
New Element	If you want to give a copied element a

Name	new name, delete the current name (highlight it and press the Delete key) and type in the new name.
Include Connectors	This checkbox defaults to selected, to make copies of the original connectors where both source and target elements in the relationship have been copied. This maintains the relationships between and organization of the copied elements. If you do not want to copy the connectors, clear the checkbox.
Paste	Click on this button to add the copied elements and connectors to the target diagram as new elements.
Don't show this again	Select this checkbox if you want to hide this dialog next time you paste an element as new (the pasted element has the same name as the original element). You can set the dialog to display again by clearing the 'Hide diagram element paste as new dialog' checkbox on the 'Objects' page of the Preferences window (select the 'Start > Application > Preferences > Preferences' ribbon option).

Notes

- Package elements cannot be copied as structured elements
- The 'Date Created' and 'Time Created' parameters of a pasted-as-new element are set to the current date and time; the parameters for a linked element remain the same as the copied element
- Elements - including special embedded elements such as SysML Properties - do not have to have a parent element when pasting as new, although normal embedded elements such as Ports must have a parent
- Elements in State regions cannot be pasted as new outside the parent element
- Parenting is still applied when copying and pasting as new using Ctrl+click-and-drag between (floating) diagrams
- You can also use the 'Cut', 'Copy' and 'Paste' icons in the Default Tools toolbar

Move/Copy Elements To & From Floating Diagrams

If you have converted a tabbed diagram in the Diagram View into a floating diagram, you have a number of context menu options to move or copy elements between that diagram and another floating or tabbed diagram.

Access

Other	Drag element(s) from one diagram to another and release mouse button
-------	--

Move or copy selected elements

Option	Action
Move to this diagram	<p>Select this option to cut the selected element or elements from the source diagram and paste them into the target diagram.</p> <p>If the moved elements are held in a different Package, when the elements are pasted each has a label underneath</p>

	<p>identifying the parent Package.</p> <p>Function Keys: Drag+Shift</p>
Create link on this diagram	<p>Select this option to create an element or elements on the target diagram, each as an instance of a selected element on the source diagram.</p> <p>Function Keys: Drag+Alt</p>
Copy as New Object(s)	<p>Select this option to create an element or elements on the target diagram, each as a copy of a selected element on the source diagram.</p> <p>The 'Paste Element(s) as New' dialog displays, on which you enter a new name for each element to identify it as a new, separate element. Click on the Paste button to complete the create task.</p> <p>Function Keys: Drag+Ctrl</p>
Instance (Object)	<p>Select this option to create an element or elements on the target diagram, each as an object instance or invocation of an element on the source diagram. The source element is the classifier for the new object element.</p> <p>Function Keys:</p>

as New Child (Generalization)	<p>Select this option to create a new child element on the target diagram, as a generalization of the element of the source diagram.</p> <p>The 'Element Name' dialog displays for each copied element, on which you enter a new name for the element to identify it as a new, separate element.</p> <p>Click on the OK button to complete the create task.</p> <p>Function Keys:</p>
----------------------------------	---

Notes

- Multiple elements are processed individually, so if one element is 'illegal' the other elements are still copied and/or transferred
- If you select multiple elements to copy as instances or generalizations, those elements must be of the same type and stereotype
- Embedded elements are moved or copied only if they are specifically selected with the parent element

Autosize Elements

You can autosize an element or group of elements in a diagram to the default size for the element type (for a Class, 90 x 70 pixels at 100% zoom). However, if the element contains more information than the default size can show (such as a long name, long attributes or additional compartments) the autosize option resizes the element to the minimum size for displaying the information.

The size change effectively operates around the mid point of each element, so the layout and size of the diagram do not change. Automatically changing the layout of a diagram is a different process.

Access

Context Menu	Right-click on selected elements Autosize (available only when multiple elements are selected)
Keyboard Shortcuts	Alt+Z

Notes

- Not all elements resize: elements such as Events remain

the same; Timing and Sequence diagrams (where position is crucial) are unchanged; and elements added from a profile or Shape Script maintain any size definitions imposed by the profile

- With an element image created with a Shape Script that contains a `defSize` command, Autosize returns the element to the `defSize` value and not the element default size

Annotations

An Annotation node is a special feature of a Package that represents the diagrammatic elements in diagrams within that Package. Diagrammatic elements are non-model elements that have no purpose outside a diagram. Such elements include:

- Notes
- Text
- Hyperlinks
- Diagram Links
- Image elements
- Boundary elements
- Navigation Cells

The system automatically creates the Annotation when you open a diagram and add diagrammatic elements. One Annotation is created for each parent Package, so if the Package has several diagrams all the diagrammatic elements are held in the one Annotation.

The Annotation does not have any properties (including not having a name), and is simply a container for the diagrammatic elements, allowing them to be listed in the Browser window and - if necessary - re-used in multiple diagrams. This also protects the elements from being deleted if any diagram that contains them is deleted. Note that if you delete all diagrams that contain the diagrammatic elements, the Annotation and its contents persists.

The Annotation is represented in the Browser window by three blue dots followed by brackets.

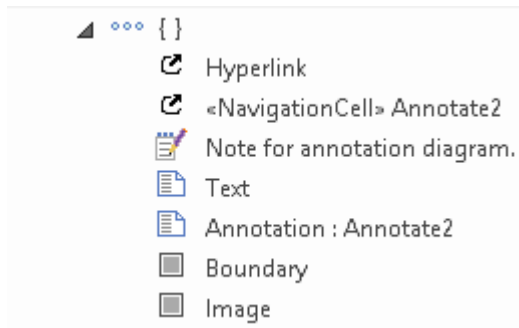

Virtual Connector Ends - Represent One Element Several Times on a Diagram

Virtual connector ends assist you to simplify complex diagrams containing many elements with multiple connectors, supporting good layout strategies that minimize crossed relationship lines and group related elements accordingly. They are highly effective when the element of interest is:

- The focus of a large number of relationships, or
- A member of two or more groups of elements that are a distance apart on the diagram, or
- Simply used in several contexts when you currently want to focus attention on one of those contexts

While Enterprise Architect does not support placing an element on the diagram more than once, using this strategy you can create any number of **virtual representations** of the element on the diagram, so that you can show the full image of the element in one context and have separate, simpler images of it on the same diagram in other contexts. This reduces the number of visible connectors crossing the diagram without you having to hide the connectors individually, and helps you create cleaner, more readable diagrams on which you can place linked elements closer together.

To achieve this, you right-click on the connector that you

want to keep the element on, and select to virtualize the appropriate connector end (source or target). The system adds a simple rectangle containing the element name and with the element fill color to the connector end, with no other connectors on it.

Consider this example:

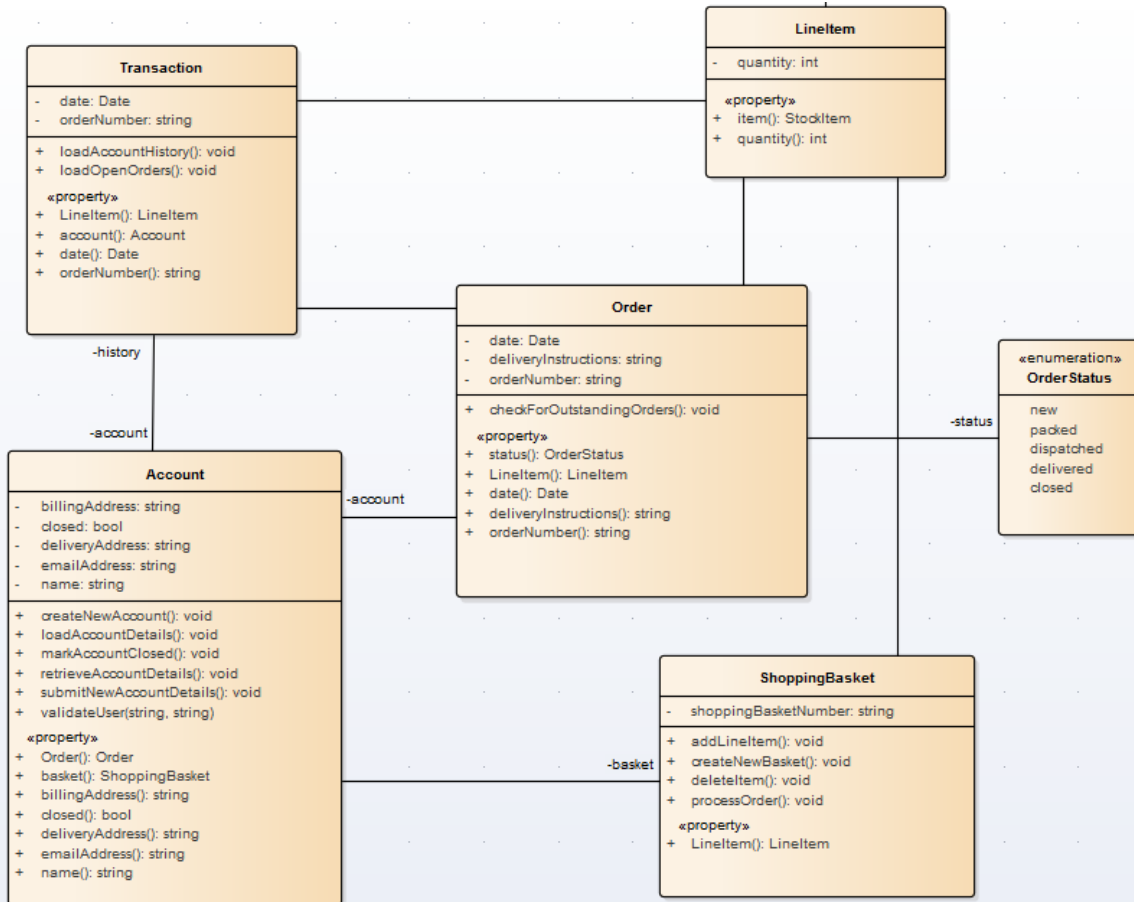

The diagram is relatively simple but still quite large, and the connector between the ShoppingBasket and LineItem elements crosses another connector. You might want to simplify the diagram for any of several reasons, such as avoiding the crossover or temporarily bringing the LineItem element more closely into the Account/Order/ShoppingBasket group as a simple participant. So, you create a virtualization of LineItem as the

target of the Association connector to ShoppingBasket.

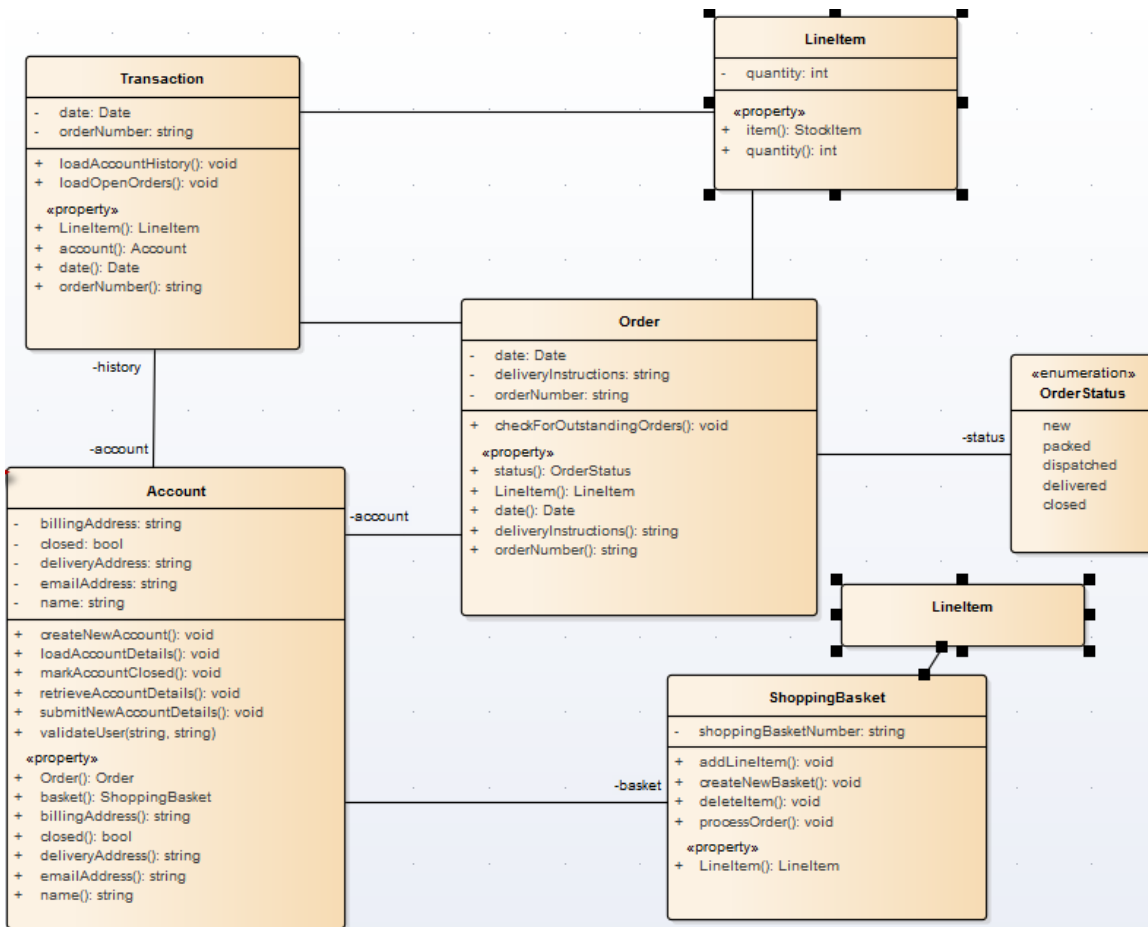

Access

<p>Context Menu</p>	<p>On diagram Right-click on connector Virtualize Connector End Target (or Source)</p>
---------------------	--

Notes

- A 'Virtual Element' is an extension of a connector that provides access to **some** of the properties of the element it

represents

- Virtualization operates on waypoints in a connector line, and therefore requires the connector line style to be set to **Custom Line**
- If no waypoints exist on the connector, the operation creates one
- If you virtualize the target element on a connector, the virtual connector end displays on the last waypoint of the connector line
- If you virtualize the source element on a connector, the virtual connector end displays on the first waypoint of the connector line
- You cannot virtualize both ends of a connector
- The original connector still exists, and if you click on the 'Virtualize Connector End' option again, the full connector redisplay and the virtual element disappears
- If you click on one virtual element, the original element and all its other virtual elements are selected and highlighted; any changes to properties made through the 'Properties' dialog of a virtual element affect the original element
- Changes to an element's **appearance** (other than fill color) do not affect its virtual elements
- Virtual elements appear on prints, reports and copies of **diagrams**; they do not appear in lists or reports on the **model** structure
- Virtual elements are specific to the diagram they are created on; if you copy a diagram (with or without virtual

elements) and add virtual elements to the copy, those changes are not reflected in the original diagram

Locate Related Elements

When you are reviewing an existing element on a diagram, it is possible that the diagram does not show all of the relationships between that element and others. The related elements might be:

- On the diagram, but with the relationships hidden, or
- Depicted on a different diagram

You can quickly check what other elements have relationships with the selected element, using the Relationships window. The right-click context menu for each relationship listed in the window also indicates if the corresponding related element is not shown on the same diagram, by providing the 'Place Related Element in Diagram' option to add the related element to the diagram. This is useful when you are building up a picture of what an element interacts with, especially when reverse engineering an existing code base. To put the element in a specific position on the diagram, click on that point.

Access

Ribbon	Explore > Portals > Windows > Trace > Relationships Start > All Windows > Properties > Responsibilities > Relations

Keyboard Shortcuts	Ctrl+Shift+2
---------------------------	---------------------

Manage Object Labels

When you create certain elements or connectors, some of the properties of the created object are displayed on the diagram as labels offset from the object. For example, these properties display as labels:

- Embedded element name
- Run state, attributes and operations (if they exist) of an element that has an alternative image
- Connector name, stereotype, constraints and/or source and target role names

You can format and hide these labels using the 'Labels' context menu.

Access

Context Menu	Right-click on a label
--------------	------------------------

Options

Option	Action
Edit Label	(Connector Labels only.)

	<p>Select this option to display the text within a small editing box, with the cursor within the text. Delete or add text as appropriate.</p> <p>Shortcut: F2</p>
Set Label Color	<p>Select this option to display the 'Color' dialog, on which you select a standard color or define a custom color in which to display the label text.</p>
Hide Label	<p>Select this option to hide the label on the diagram; to reveal the label again:</p> <ul style="list-style-type: none"> • For an element label, right-click on the element and select the 'Appearance Show labels' option • For a connector label, right-click on the connector and select the 'Visibility Set Label Visibility' option; select the checkbox against each label to redisplay <p>You can also hide all connector labels on a diagram using the 'Suppress All Connector Labels' option on the 'Connectors' tab of the 'Properties' dialog for the diagram.</p>
Bold	<p>Select this option to display the label text in bold.</p>

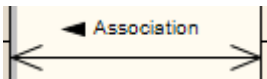
<p>Label Rotation</p>	<p>(For embedded elements and connectors.) Select this option to orient the label in the horizontal (default) or vertical planes. You can rotate the text in the vertical plane either clockwise or anti-clockwise from horizontal.</p>
<p>Text Alignment</p>	<p>Select this option to align the text to the left, center or right of the label text area. This is more apparent where there are several items of text in the label, of different lengths.</p>
<p>Direction</p>	<p>(Connector name labels only - ensure that the connector has a name.) Select this option to set or clear a small arrow on the name label. You can choose to set the arrow pointing to the label source or destination.</p>  <p>This arrow is part of the label, so if there is no label text (or if the label consists only of spaces) there is no direction indicator.</p>
<p>Default Position</p>	<p>Select this option to move the label to the position it was initially created in, relative to the parent element or</p>

	connector.
Default Color	Select this option to set the label color to the default color in which it was first created.

Notes

- As labels can be concentrated on and around the element or connector, try to click on a section of the required label that is clear of any other label or structure
- The 'Label Rotation' option is not currently available for stereotyped elements and connectors

Hide/Show Labels

A connector can have a number of different labels along its length and at each end. It is possible to selectively hide or display these labels to reduce the volume of text around the connector or to focus attention on specific properties.

Access

Context Menu	Right-click on connector Visibility Set Label Visibility
--------------	--

Hide or display labels on a connector

Step	Action
1	<p>On the 'Label Visibility' dialog:</p> <ul style="list-style-type: none"> • Select the checkbox against each label to show, and • Clear the checkbox against each label to hide
2	<p>Click on the OK button.</p> <p>The diagram displays the connector with the selected labels shown.</p>

Show Realized Interfaces of Class

If you are modeling interfaces that are directly realized by a Class, you can render each of those interfaces as a 'lollipop' style interface node, which protrudes from the left-hand side of the Class.

Consider this example:

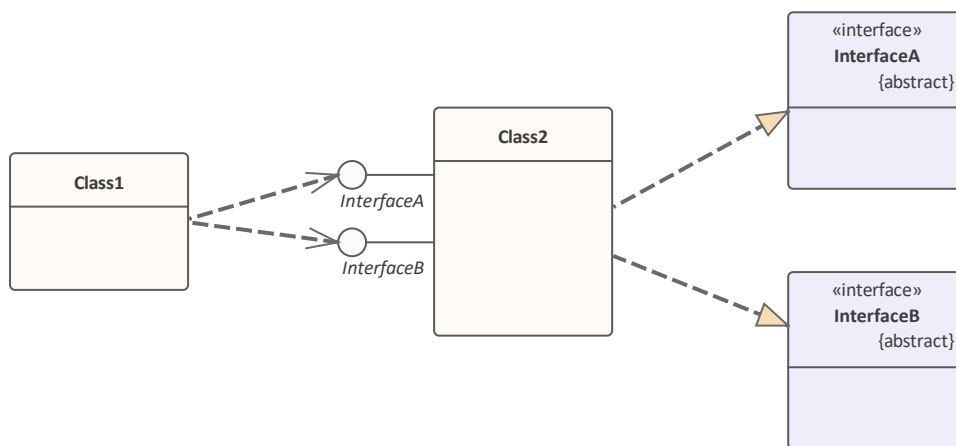

The Bank Class realizes (or *provides*) the Internet Banking Interface. The diagram would be a useful depiction of this simple relationship if you wanted to populate the elements with visible features and properties. However, in more complex diagrams with more detailed realized (and dependent) interfaces, you might not want to show all the information defining each element. Therefore you can represent the realized interface as the 'lollipop' node, and remove the original Interface element from the diagram (but not from the model).

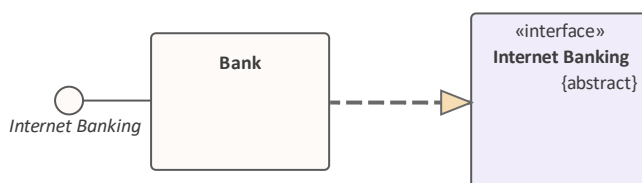

and then

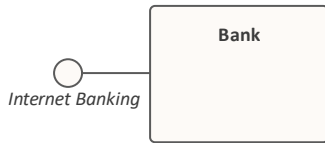

To depict the interfaces that a Class realizes as nodes, right-click on the Class and select 'Features | Show Realized Interfaces'. This setting only applies to the selected Class, and can be changed at any time. If you turn the option off, in the scenario here, neither the node nor the Interface element are shown. If you turn the option back on, the node redisplay.

Notes

- There are various mechanisms for showing that an interface is realized by one object and required by another, including using the Expose Interface element; however, the simplest method of representing such interactions is to create an Assembly connector between the 'realizing' object and the 'using' object

Open Package From Diagram

As you develop your model, you might create diagrams that show the organization and/or content of some or all of the Packages in the model. From a Package element shown in one of these diagrams, you can quickly locate and expand the Package in the Browser window and open the Package default diagram in the Diagram View.

The default diagram is the first available diagram in the Package, selected in alphabetical order - for example, a diagram called Alpha in a child Package or element several levels down opens before a diagram called Beta immediately under the selected Package.

Access



Double click on the Package.

Keyboard Shortcuts	Ctrl+K
--------------------	--------

Undo Last Action

When you are editing diagrams, moving, re-sizing and deleting elements and deleting connectors, and you make a mistake, you can work back through multiple levels of undo to roll back the error.

Access

Ribbon	Layout > Diagram >  Undo
Keyboard Shortcuts	Ctrl+Z
Other	Click on the Undo button in the Default Tools toolbar - 



Notes

- Currently you cannot undo element additions or connector moves
- If an undo action is itself in error, you can reverse it with a redo action

Redo Last Action

When you are editing diagrams, moving, re-sizing and deleting elements and deleting connectors, and you make a mistake, you can work back through multiple levels of undo to roll back the error. If the undo actions are themselves in error, you can reverse them with the equivalent number of redo actions.

Access

Ribbon	Layout > Diagram >  Redo
Keyboard Shortcuts	Ctrl+Y
Other	Click on the Redo button in the Default Tools toolbar - 

Add Diagram Links to Diagrams

Whilst a diagram usually represents a structure of modeling objects, it can also act as a portal through which you can access related diagrams that provide more detail on an aspect, or alternative views of the structure, or views of other structures. Where there are many diagrams (or, indeed, other objects and features) to move on to, the initial diagram can become a home page for a part of the project, or even the entire project.

Several options for linking to another diagram are provided by the 'Select Type' dialog, which displays when you drag the target diagram from the Browser window onto the host diagram.

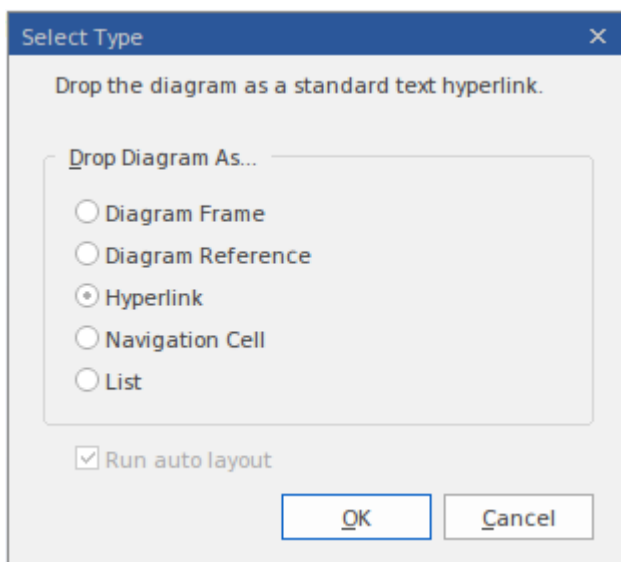

Drop Diagram Options

Select the appropriate option to set up the required type of link to the target diagram, and then click on the OK button.

Option	Description
Diagram Frame	<p>This option creates a Diagram Frame element containing an image of the dropped diagram, with the name of the dropped diagram in the frame label. Any user looking at the host diagram can double-click on the Diagram Frame and open the target diagram for review and - if they have the access permissions - for edit.</p>
Diagram Reference	<p>This option creates an empty Diagram Frame element with the name of the dropped diagram in the frame label. Any user looking at the host diagram can double-click on the Diagram Frame and open the target diagram for review and - if they have the access permissions - for edit.</p> <p>You can also open the referenced diagram from the Browser window, by double-clicking on the Diagram Frame name.</p>
Hyperlink	<p>This option adds a Hyperlink element to the diagram, containing a diagram icon with no frame, followed by the names of the parent Package and target diagram.</p>

	<p>Double-clicking on this hyperlink will open the target diagram.</p> <p>You can edit the hyperlink to point to another diagram, or to not display the diagram icon, by right-clicking on the element and selecting the 'Properties' option.</p> <p>You can also create an identical Hyperlink element by dragging the Hyperlink icon onto the host diagram from the 'Common' Toolbox page, right-clicking on the element and selecting 'Properties', and then selecting 'Diagram' from the 'Type' drop-down list.</p>
Navigation Cell	<p>This option creates a Navigation Cell (a UML Diagram element) that contains the name of the target diagram and, in the top right corner, an icon representing the diagram type. Just after you click on the OK button, the 'Select Image' dialog displays, from which you can select a graphic that represents the nature of the diagram. You can also select a diagram Theme for the image, from the 'Image List' field. If you do not want to add an image to the element, click on the Cancel button.</p>

List

This option creates a Model View chart that lists the elements within the target diagram. When you select the option and click on the OK button, the Model View element 'Properties' dialog displays at the 'Chart Details > Source' page, showing the SQL statement that populates the list. Click on the OK button to execute the search and generate the List of Elements Chart.

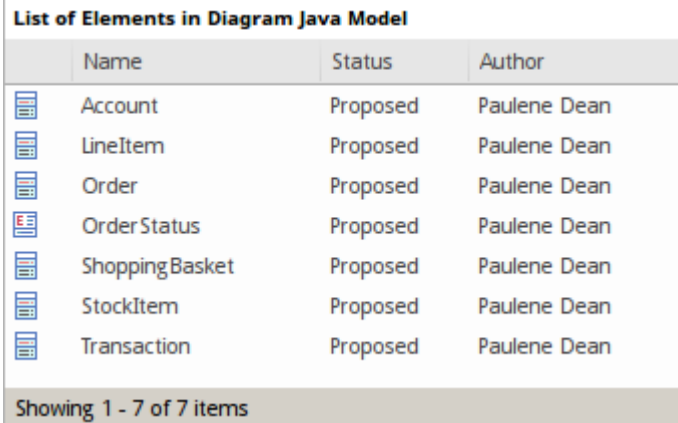

	Name	Status	Author
	Account	Proposed	Paulene Dean
	LineItem	Proposed	Paulene Dean
	Order	Proposed	Paulene Dean
	OrderStatus	Proposed	Paulene Dean
	ShoppingBasket	Proposed	Paulene Dean
	StockItem	Proposed	Paulene Dean
	Transaction	Proposed	Paulene Dean

Showing 1 - 7 of 7 items

Other Links to Diagrams from Diagrams

There are additional ways to link to and access one diagram from another. These include:

- From the Browser window, drag a Package containing the target diagram (as the first diagram listed in the Package) onto the host diagram, and select the 'Package Element' option; when a user double-clicks on the Package element on the host diagram, the target diagram displays

- Right-click on a suitable element in the host diagram and select the 'New Child Diagram | Composite Structure Diagram' option, then double-click on the element to display the first diagram underneath the element; if that is not the required diagram, right-click on the element and select the 'New Child Diagram | Select Composite Diagram' option, then choose the target diagram from the 'Select Classifier' dialog
 - You can display the target Composite diagram instead of the parent element on the host diagram; right-click and select the 'New Child Diagram | Show Composite Diagram in Frame' option
 - Alternatively, you can display the target diagram in a compartment within the parent element outline; right-click and select the 'New Child Diagram | Show Composite Diagram in Compartment' option
- For most types of diagram link, when a user clicks on the link the target diagram opens; the diagram name tab has a small arrow on it which, when you double-click on it, returns you to the original diagram ( Class Diagram ←), closing the linked diagram

Hyperlinks Between Diagrams

Create a hyperlink between diagrams

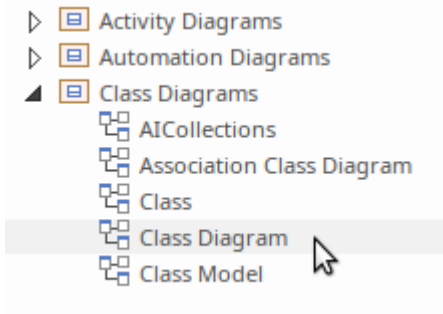
Step	Action
1	<p>Open the diagram in which to display the hyperlink to another diagram.</p> <p>From the Browser window select the diagram you want to create a hyperlink to:</p>  <ul style="list-style-type: none">Activity DiagramsAutomation DiagramsClass Diagrams<ul style="list-style-type: none">AICollectionsAssociation Class DiagramClassClass DiagramClass Model
2	<p>Drag the diagram on to the current diagram.</p> <p>The 'Select Type' dialog displays.</p>
3	<p>Select the 'Hyperlink' option and click on the OK button.</p> <p>The final hyperlinked diagram should resemble this diagram, where the 'Class' diagram is the diagram to which the 'Product Order' diagram hyperlinks (notice that the hyperlink icon is different).</p>

Example

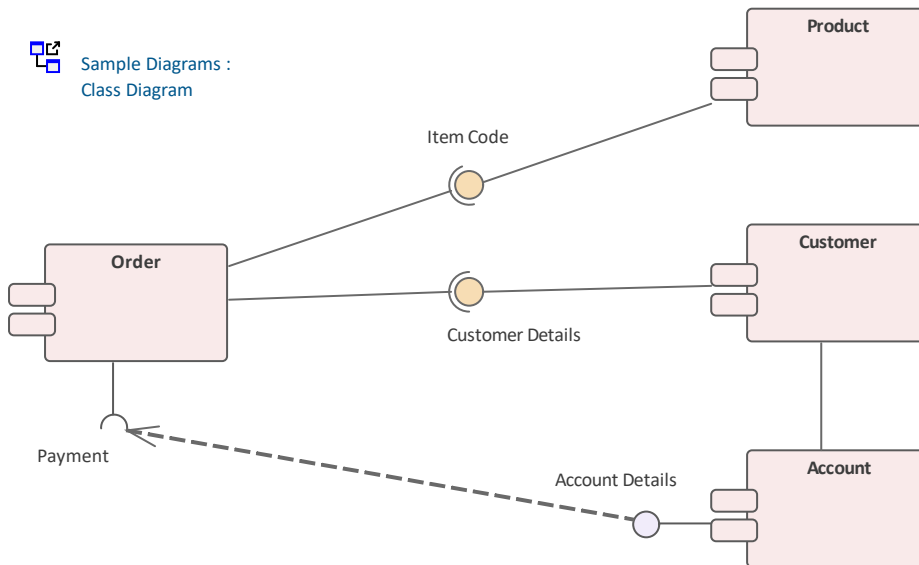

Notes

- If the hyperlink appears as a Sub Activity, select the 'Start > Appearance > Preferences > Preferences > Diagram > Behavior' option and deselect the 'Use Automatic SubActivities' checkbox
- When a user clicks on the hyperlink, the linked diagram opens (in the example, *Class*); the diagram name tab has a small arrow on it which, when you double-click on it, returns you to the original diagram () , closing the linked diagram

Pan and Zoom a Diagram

When you are viewing a diagram, you can pan across, up and down the whole diagram in a low magnification to locate a particular section, and then zoom into that section in a higher magnification.

Pan over diagram

You can pan over the Diagram View using the:

- Left, Right, Up, Down, Page Up, Page Down, Home and End keys when the Diagram View is selected
- Diagram scrollbars
- Middle mouse button
- Pan & Zoom window (Ctrl+Shift+4)

Zoom into and out of diagram

You can zoom into and out from the diagram using the:

- 'Layout > Diagram > Zoom' options or
- The Zoom + and - icons and slider bar in the Status bar at the bottom of the screen, or
- Zoom buttons on the Diagram toolbar or Pan & Zoom window toolbar



Change the zoom level by clicking on either the Zoom In (+) button or Zoom Out (-) button; each click changes the

magnification by 10%.

You can return the diagram to 100% in one of these ways:

- Click on the  ('Zoom to 100%') button
- Press Ctrl and click on the middle button of the mouse

Notes

- You can zoom in and out of the main window dynamically by holding Ctrl and rolling the mouse wheel
- Changes in diagram magnification through the zoom options can be saved as permanent changes to the diagram
- At high levels of zoom, element features cease to display; this is because the Windows font mapper cannot easily select a font for extreme conditions, and the result can look odd

Diagram Navigation Hotkeys

Whilst you are working on a diagram, a number of facilities are also available to you through the keyboard keys. Some of these facilities are exclusively provided by keyboard keys - the diagram navigation hotkeys - which you can use to quickly move or operate on elements within a diagram.

Keys

Key Combination	Facility
Shift+Arrow	Move the selected element(s) by increments (in the direction of the arrow).
Arrow key	Scroll the diagram (in the direction of the arrow).
Esc	Clear the current selection. (Alternatively, simply click on the diagram background.)
Tab key	(If no element is selected) Select the element with the lowest Z-Order number - the furthest back in the diagram. (If an element is selected) Move focus to the element with the next-lowest Z Order

	number (coming forward out of the diagram).
Shift+Tab	(If no element is selected) Select the element with the highest Z-Order number - the furthest forward in the diagram. (If an element is selected) Move focus to the element with the next-highest Z Order number (moving back into the diagram).
Shift+click or Ctrl+click	Toggle the addition of the clicked element to the current selection. If you are clicking on the area of overlap between elements: <ul style="list-style-type: none"> • Shift+click toggles selection of the element with the lower Z-order (the element behind or further back than the others) • Ctrl+click toggles selection of the element with the higher Z-order (the element in front of or further forward than the others)
Alt+G	Locate the item in the Browser window and highlight it.
T	When you have selected an element in the diagram, you can press the T key to open the Test Cases window for that

	element.
--	----------

View Previous and Next Diagram

If you are working on more than one diagram at a time, and have the diagrams open on separate tabs, you can step backwards and forwards through them. You will also step through any other views that are open, such as the Model Search, Project Gantt chart and Start Page.

You move between views using buttons on the floating Diagram Toolbar:



To access

- The previous diagram or view, click on the Previous Diagram button or press Alt+Left
- The next diagram or view, click on the Next Diagram button or press Alt+Right
- The default model diagram (if one has been defined) click on the Home Diagram button

Change Diagram Type

If necessary, you can change the type of a diagram to another type. This is useful if you have either made a mistake in selecting the diagram type to begin with, or if the purpose and nature of a diagram changes during analysis.

Access

Ribbon	Design > Diagram > Options > Change Type
--------	--

Change a Diagram Type

Step	Action
1	<p>On the 'Change Diagram Type' dialog, click on the 'Select From' header and select the appropriate Perspective group, and then select the Perspective from the panel beneath the header.</p> <p>The 'Diagram Types' panel displays a list of the diagram types for the selected Perspective; click on the diagram type to change the diagram to.</p>

2	In the 'Diagram Types' panel, click on the diagram type to change to.
3	Click on the OK button to change the diagram type. The system checks whether there is a template diagram for this diagram type in the Templates Package and, if so, applies the display characteristics defined in that template.

Notes

- Some diagram types do not switch to others - for example, you cannot change a Class diagram into a Sequence diagram; you can change, say, a Sequence diagram from one technology into a Sequence diagram from a different technology

Grid-Style Diagrams

Grid-style diagrams allow you to manage and organize diagrams, by sorting diagram elements into cells within a grid. The grid functionality integrates with the new scripting API to facilitate setting the appearance of diagram elements dynamically, as the diagram is loaded.



Access

<p>Properties Window</p>	<p>Select 'Enable' from the drop-down list for the option 'Grid-style' under the heading 'Appearance'.</p>
---------------------------------	--

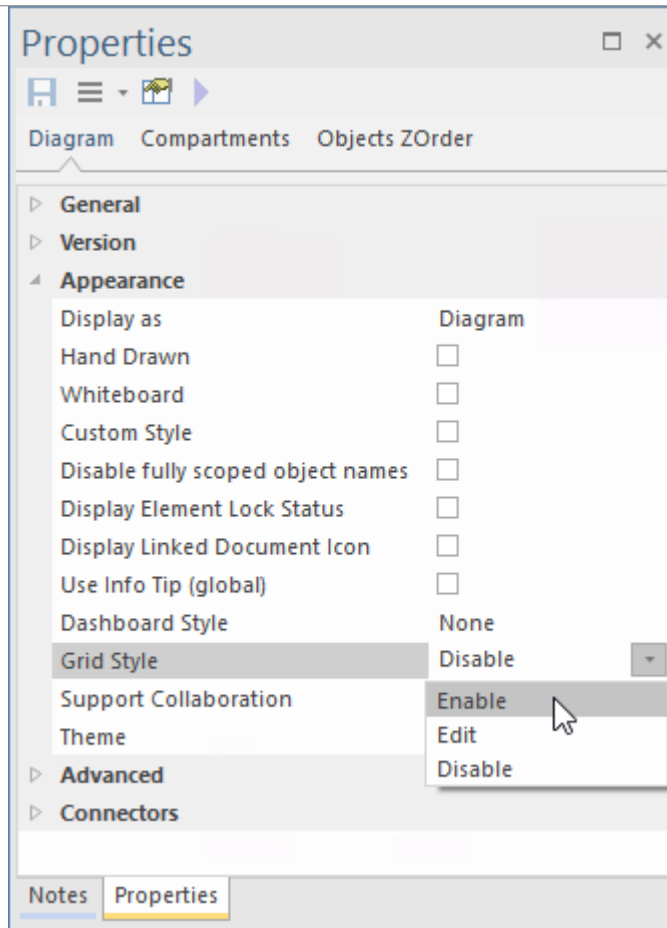

This action turns on the 'grid-style' setting and opens the 'Grid Properties' dialog, where you can specify the Grid settings.

Context Menu

For diagrams that are displayed with Grid-Style enabled, the context menu option 'Grid' offers a number of commands specific to grid-style diagrams.

They are:

- Show Grid Lines
- Show Grid Headers
- Edit Grid

- Compact Grid

Setting the Grid Style Properties

Enabling 'Grid-Style' on a diagram creates a number of columns on the diagram, according to the values specified in the 'Grid Properties' dialog. The rows are laid out dynamically according to the number of columns and the number of elements on the diagram.

The 'Grid Properties' dialog is displayed at the time of enabling grid-style for a diagram.

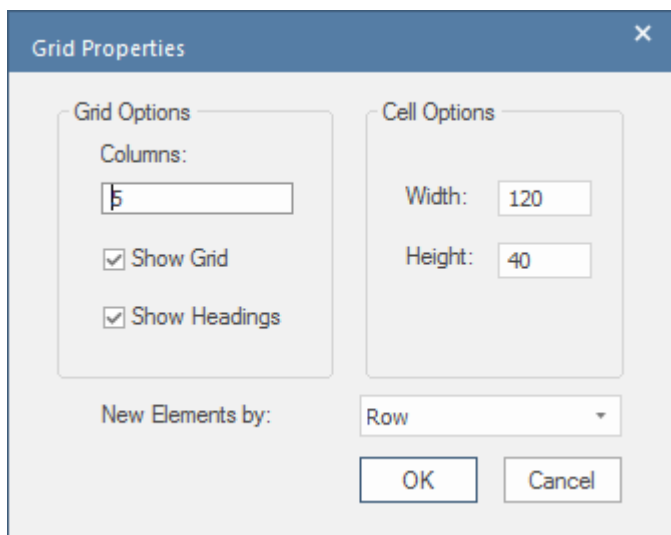

The dialog can also be displayed at any time after grid-style has been enabled, by selecting the context menu option 'Grid > Edit Grid'.

On the dialog you set a number of properties:

- The number of columns
- Whether to show the grid lines
- Whether to show the column headings

- The width of the cells
- The height of the cells
- How to add new elements to the diagram - if the cell the element is being added to is already occupied, this option determines if the system searches for the first free cell by row (searching left to right/top to bottom) or by column (top to bottom/left to right)

Altering the Grid Cells Using Scriptlets

Scriptlet artifacts can be used to run JavaScript code to access elements in a grid-style diagram and set the appearance of those elements. For example, to set the font and background color, or to alter the text that is displayed. Each Scriptlet has access to three global objects in addition to the standard automation environment. They are:

- `theDiagram` - an automation Diagram interface to the diagram on which the Scriptlet resides
- `theElement` - an automation Element interface to the Scriptlet artifact itself
- `theInstance` - an automation DiagramObject interface to the Scriptlet artifact itself

When a diagram is viewed as a grid, we can use automation functions to retrieve elements at specified grid locations. The location format is the same as one sees in a spreadsheet, with columns labeled 'A', 'B', 'C', ..., 'AA', 'AB', etc. and the rows numbered in sequence.

To alter the appearance of a grid element, retrieve its

underlying Object, using the function `GetObjectByGrid`.

To alter the value of a grid element, retrieve its underlying Element, using the function `GetElementByGrid`.

For example;

```
object = theDiagram.GetObjectByGrid("A", "2");
```

```
element = theDiagram.GetElementByGrid("A", "2");
```

A diagram can contain any number of Scriptlet artifacts.

The Scriptlets will run before the diagram is displayed, and whenever the diagram is reloaded. When there are multiple Scriptlets on a diagram, the order in which they are executed is determined by their Z-order on the diagram.

Scriptlets

Scriptlet elements contain JavaScript that lets you tap into the underlying diagram and element API for customizing the element's appearance, text, Tagged Values and other properties on the fly. Scriptlets run whenever the diagram is loaded, or can be run manually on demand, providing diagrams with more than a single static view.

Each Scriptlet has access to three global objects in addition to the standard automation environment. They are:

- `theDiagram` - an automation Diagram interface to the diagram on which the Scriptlet resides
- `theElement` - an automation Element interface to the Scriptlet artifact itself
- `theInstance` - an automation DiagramObject interface to the Scriptlet artifact itself

For references to Help topics related to these objects see the *Learn More* links.

Access

Scriptlets can be placed on any diagram. You can place any number of Scriptlets on a diagram and you can place a given Scriptlet on more than one diagram.

Perspective	Construction > Scriptlets
Diagram	

Toolbox

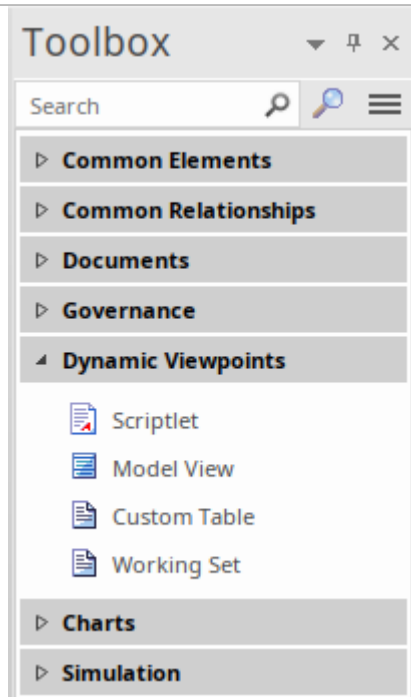

To create a Scriptlet:

- Open the Toolbox
- Select the Scriptlet artifact from the 'Dynamic Viewpoints' page of the diagram toolbox
- Drag it onto an open diagram

Scriptlet Permissions

Code in Scriptlets cannot alter or update elements in the model database. It can, however, read and update copies of the elements that are displayed on a diagram. Updates to elements made by Scriptlets are NOT written back into the model database.

Editing Scriptlet Code

To add code to a Scriptlet, or to edit existing code for a Scriptlet, either double-click on the Scriptlet on a diagram, or right-click and select the 'Edit Script' menu option. The Code Editor window opens, showing the code for the selected Scriptlet. Edit the JavaScript code for the Scriptlet, as you would in any code editor. Press the Ctrl+S keys to save your changes.

An Example of a Scriptlet

This example comes from the model pattern 'Scriptlets > Simple', available through the Model Builder.

```
//--- Example Scriptlet ---  
function Scriptlet1()  
{  
    var object as EA.DiagramObject;  
    object = theDiagram.GetObjectByGrid("A","2");  
    if(object)  
    {  
        Session.Output("Scriptlet1 for " +  
theDiagram.Name);  
        object.BackgroundColor =  
parseInt("0x554444",16);  
        object.FontColor = parseInt("0xeeeeee",16);  
    }  
}
```



```
        object.Update();  
    }  
}
```

```
Scriptlet1();
```

Running a Scriptlet

Scriptlets are run whenever the diagram containing them is loaded or reloaded, prior to the diagram being displayed. If a diagram contains multiple Scriptlets, the order in which they are run is determined by the Z-order of the Scriptlets on the diagram. Scriptlets can also be run manually at any time, by right-clicking on the Scriptlet and choosing the option 'Run Script' from the context menu.

Debugging a Scriptlet

You can debug a Scriptlet as for any other section of code. Right-click on the Scriptlet and select the 'Debug Script' menu option. The Scriptlet is displayed in the Debug View.

Scriptlets on Grid Style Diagrams

The automation API has some specialized functions that Scriptlets can use when acting on diagrams displayed in a Grid style. When a diagram is viewed as a grid, we can use automation functions to retrieve elements at specified grid

locations. The location format is the same as one sees in a spreadsheet, with columns labeled 'A', 'B', 'C', ..., 'AA', 'AB', etc. and the rows numbered in sequence.

To alter the **appearance** of a grid element, retrieve its underlying Object, using the function `GetObjectByGrid`.

To alter the **value** of a grid element, retrieve its underlying Element, using the function `GetElementByGrid`.

For example;

```
object = theDiagram.GetObjectByGrid("A", "2");
```

```
element = theDiagram.GetElementByGrid("A", "2");
```

Entry points and Multiple Scriptlets

When using a single Scriptlet it requires an entrypoint for the execution of the Scriptlet. As this invocation is in the global scope, the Scriptlet will execute when it is loaded. For example the line: *Scriptlet3()* is the entry point for:

It is possible to have Scriptlets that simply define functions that are called by other Scriptlets. One could have a single Scriptlet with an entry point, for example, and several other Scriptlets that simply define a library of functions or set some data.

There should, however, be at least one entrypoint defined in one of the diagram's Scriptlets. Where there are multiple Scriptlets and only one entrypoint, the Scriptlet with the entrypoint should be the last to run.

To set the ordering, in which these are compiled and executed, use the z-ordering and set the main Scriptlet with the entry point to higher than the others and hence the last to run.

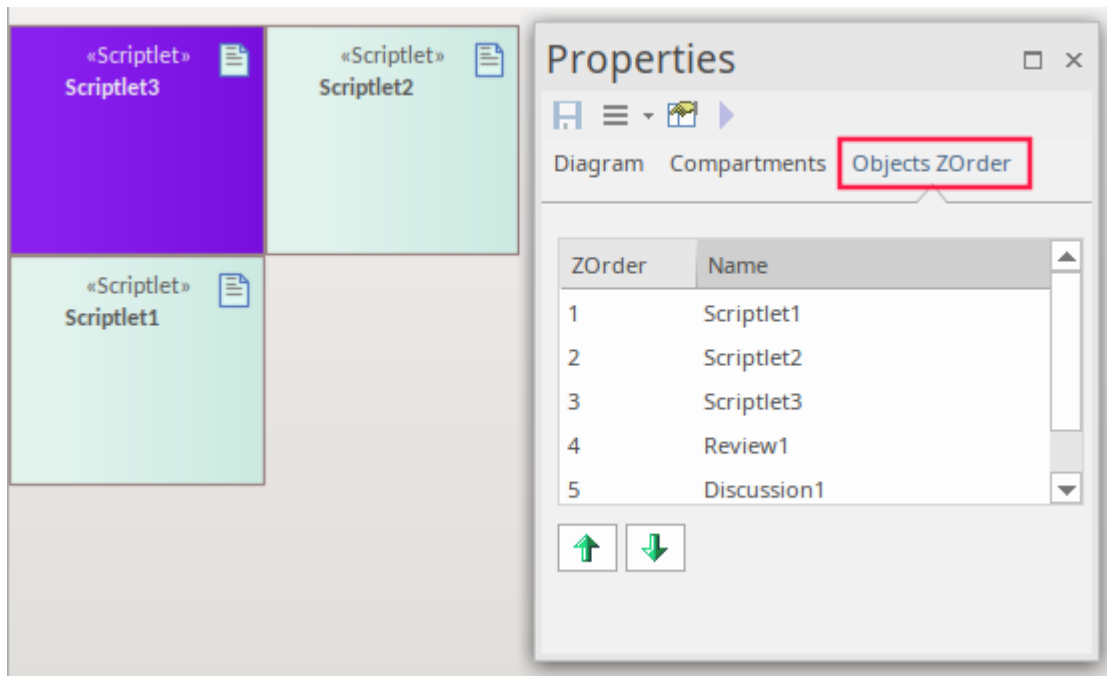

```
function Scriptlet3()
```

```
{
```

```
    var element as EA.Element;
```

```
    var object as EA.DiagramObject;
```

```
    element = FindDiagramElement("Discussion1");
```

```
    if(element)
```

```
    {
```

```
        object = FindDiagramObject(element.ElementID);
```

```
        object.BackgroundColor =
```

```
parseInt("0xc0c0c0",16);
```

```
        object.Update();
```

```
    }
```

```
}
```

```
Scriptlet3();
```

Using Scriptlets in MDG Technologies

Scriptlets can be incorporated into the definition of an element stereotype, as part of a Profile in an MDG Technology. In this way, Scriptlets can be used to perform on-the-fly changes to an element's properties and presentation.

To add a Scriptlet to an element stereotype, within the element used to define the stereotype create an attribute named '_scriptlet' and place the script code into the 'Initial Value' field of that attribute's properties. The JavaScript language is used to write the Scriptlet code.

For more detail see *_scriptlet* in the *Special Attributes* Help topic.

Example Use of a Scriptlet in a Stereotype

In this example, the element that defines the stereotype 'Person', defines (among other things) three attributes, 'Height', 'Weight' and 'BMI'. It also defines the special attribute '_scriptlet', that assigns a value to 'BMI', that is calculated as 'Weight' divided by the square of 'Height'.

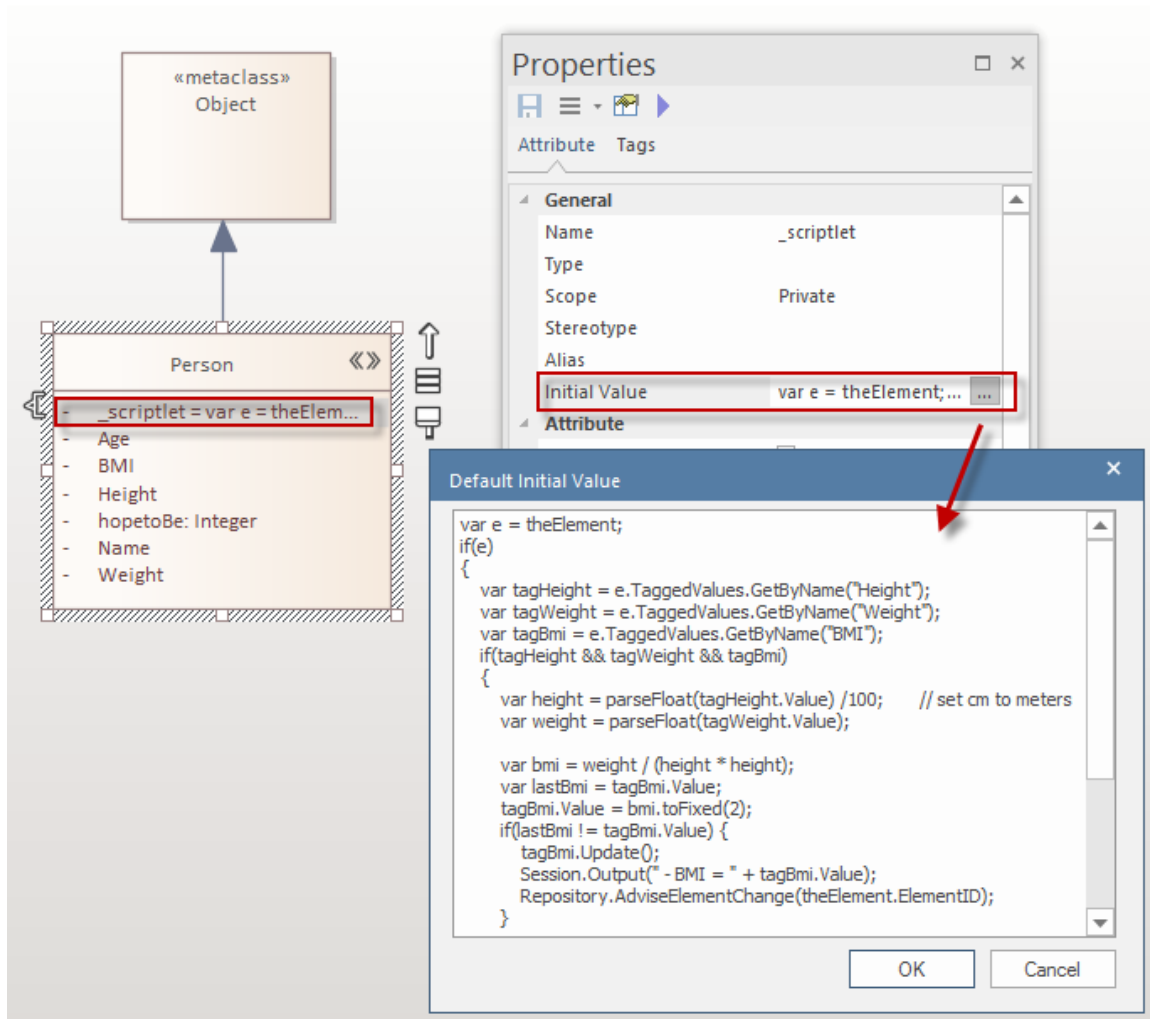

Here is an example of an element created using the 'Person' stereotype, that includes the BMI Scriptlet.

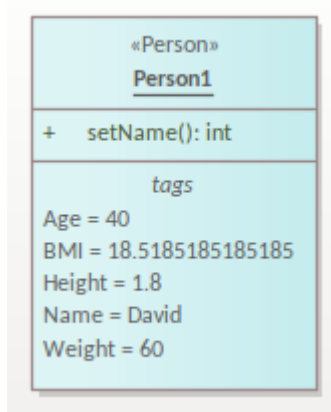

Note that the attributes of the stereotype, become Tagged Values in elements created with that stereotype.

Scale Image to Page Size

When you print a diagram, the default setting is to scale the image to fit the size of the printer paper you have defined in the page set-up. The image is not scaled up to fill the page, but it is scaled down if it exceeds the current page boundary. The image retains its current proportions; that is, it is scaled down equally in the X and Y dimensions. For a large diagram, this can mean that the components of the diagram are small and hard to read.

Alternatively, you can print a multi-page image; that is:

- allow the diagram image to print on as many printer pages as it naturally occupies, (no scaling), or
- scale the diagram image to exactly fit a specified number of pages

In all three cases you also define the paper size and orientation.

Access

Ribbon	Design > Diagram > Manage > Properties > Diagram: Advanced
Context Menu	Right-click on background of open diagram Properties > Diagram: Advanced Right-click on diagram in Browser

	window Properties > Diagram: Advanced
--	--

Turn off or customize image scaling options

Step	Action
1	<p>Select from these options as required:</p> <ul style="list-style-type: none">• 'None': select to print on as many pages as the diagram image requires• 'Scale to 1 page': select to scale the diagram image to fit on the currently selected page• 'Custom': select to specify the width and height of the diagram images in terms of the number of pages in height and width; specify the number of pages for each dimension• 'Page Setup': click to select the page size and alignment

Notes

- Before printing, make sure you have selected the required page layout using the Page Setup button

Set Up Diagram Page

You can change the size of the diagram area (or scrollable/printable area) using the 'Properties' dialog for the diagram.

Access

Ribbon	Design > Diagram > Manage > Properties > Diagram
Context Menu	Right-click on background of open diagram Properties > Diagram Right-click on diagram in Browser window Properties > Diagram

Set the page size

Step	Action
1	Select the 'Show Page Border' checkbox.
2	On the 'Page Setup' panel, click on the Advanced button.

	The 'Print Advanced' dialog displays.
3	<p>Click on the Page Setup button. The 'Page Setup' dialog displays. As you adjust the settings on this dialog, the page icon at the top illustrates the effects of your changes.</p>
4	<p>In the 'Size' field, click on the drop-down arrow and select an appropriate page size.</p>
5	<p>In the Orientation panel click on the radio button for the orientation of the page to print.</p>
6	<p>In the Margins panel, type the required left, right, top and bottom page margins for the diagram, in inches.</p>
7	<p>Click on the OK button on the 'Page Setup' dialog, the 'Print Advanced' dialog, and the 'Properties' dialog for the diagram, in turn. The area within the page boundary lines on your diagram is expanded or reduced accordingly. When you print or print preview, the output is cropped to these boundary lines and the diagram divided between the necessary number of pages.</p>

Notes

- You can set the default paper size for new diagrams on the 'Diagram' page of the 'Preferences' dialog (select the 'Start > Appearance > Preferences > Preferences > Diagram' ribbon option); once the paper size is set there, all new diagrams have that as the default size
- In the Corporate, Unified and Ultimate Editions of Enterprise Architect, if security is enabled you must have 'Update Diagrams' permission to change diagram page set up

Lock Diagram

If User Security is not enabled, to protect a diagram against inadvertent changes such as moving or resizing elements, you can lock the diagram. If you or any other users select any object on a locked diagram, the object's border or outline displays in red.

Access

Context Menu	Right-click on the background of open diagram Lock Diagram
--------------	--

Notes

- This does not apply in the Corporate, Unified and Ultimate Editions if User Security is enabled; in this case, see the *Lock Model Elements* topic
- To unlock the diagram, select the 'Lock Diagram' menu option again

Copy (Duplicate) or Move Diagram

As you develop the diagrams in your model, you might find that some of the diagrams use many of the same elements and have a similar format. You can copy and replicate the complete diagrams for minor modification, resulting in a duplicate diagram with either:

- Links back to the original diagram elements, unless those elements are Text, Note, Hyperlink, Lifeline or Object elements, or embedded elements on Objects, that are specific to the diagram and that are copied (shallow mode) or
- Complete copies of all elements in the diagram, other than Packages (deep mode) or
- Complete copies of all elements in the diagram that have the same parent as the diagram, and links back to the original diagram elements for all other elements on the diagram (smart mode)

You might find that a diagram is better held in a different Package - such as a diagram library - and you need to move it. To do this you simply open the parent and target Packages in the Browser window, click on the diagram and drag it from the parent to the target. Note that some diagrams - particularly those in Systems Engineering - show diagram frames that are renderings of the element that currently holds the diagram. As you are moving the diagram to a new owner, you are breaking that relationship between the parent element and the diagram, so you need to turn off

the display of the diagram frame before moving the diagram. See the *Diagram Context Menu* Help topic.

Access

Context Menu	<p>Right-click on diagram in Browser window Copy/Paste Copy Diagram then:</p> <p>Right-click on Package Copy/Paste Paste Diagram or</p> <p>Right-click on element Copy/Paste Paste Diagram</p>
Keyboard Shortcuts	<p>Copy the diagram then:</p> <ul style="list-style-type: none"> • Select Package > Ctrl+V or • Select element > Ctrl+V

Duplicate a diagram

Option	Action
Name	Type the name for the new diagram.
Type of copy	Click on the radio button for the type of copy you require; either:

	<ul style="list-style-type: none">• Shallow• Deep, or• Smart
OK	<p>Click on this button to initiate the copy.</p> <p>The new diagram is automatically created with linked or new elements arranged as in the original diagram.</p> <p>All connectors are also copied between diagram elements where appropriate.</p>

Notes

- In the Corporate, Unified and Ultimate Editions of Enterprise Architect, if security is enabled you must have 'Manage Diagrams' permission to copy diagrams
- For a diagram copied in shallow mode, any changes to the properties of the original elements are reflected only in those elements that are copied as simple links in the pasted diagram
- For a diagram copied in deep mode, any changes to the properties of the original elements are not reflected in the elements in the pasted diagram
- For a diagram copied in deep mode, Package elements are copied as simple links only; you cannot paste as new
- For a diagram copied in smart mode, any changes to the

properties of the original elements are reflected only in those elements that are copied as simple links in the pasted diagram

- Element position and size are independent in all copy modes

Save Diagram Image to File

It is possible to capture a modeling diagram as an image file in your file management system, for later use in - for example - external documents and presentations. You can capture the image in a number of different file formats, including:

- Windows bitmap
- GIF image
- Windows Enhanced Metafile (standard metafile)
- Windows Placeable Metafile (older style metafile)
- PNG format
- JPG
- TGA
- SVG

Access

Ribbon	Publish > Diagram Image > Save > Save to File
Keyboard Shortcuts	Ctrl+T

Capture a diagram as an image file

Step	Action
1	On the 'Save As Image' dialog, select the appropriate folder location for the file.
2	In the 'File name' field, type the file name to save the image under.
3	In the 'Save as type' field, click on the drop-down arrow and select the appropriate file format.
4	Click on the Save button.

Notes

- The system clips the image size to the smallest bounding rectangle that encompasses all diagram elements
- You can scale the size of the saved (bitmap) image upwards or downwards, using the option on the 'Diagram' page of the 'Preferences' dialog ('Start > Appearance > Preferences > Preferences > Diagram')
- You can also enable and disable Diagram Frames on the images that you capture of a diagram, on the same page of

the 'Preferences' dialog

- By deselecting the 'Printable' option on an element on a diagram, you can omit that element from the diagram image copied to file

Copy Image to Clipboard

It is possible to capture a modeling diagram as an image on the MS Windows clipboard for immediate use in - for example - external documents and presentations in MS Word™ or other applications, or in another diagram within Enterprise Architect.

You can set the format of the clipboard images - bitmap or metafile - on the 'Preferences' dialog ('Start > Appearance > Preferences > Preferences' ribbon option; the dialog opens at the 'General' page).

Access

Ribbon	Open diagram, then: Publish > Diagram Image > Save > Save to Clipboard
Keyboard Shortcuts	Open diagram, then press Ctrl+B.

Notes

- You can scale the size of the saved (bitmap, or non-metafile) image upwards or downwards, using the option on the 'Diagram' page of the 'Preferences' dialog

('Start > Appearance > Preferences > Preferences > Diagram')

- You can also enable and disable Diagram Frames on the images that you capture of a diagram, on the same page of the 'Preferences' dialog

Delete Diagrams

Diagrams are representations of the ways in which model element structures are organized. If you no longer want to depict an arrangement of model elements, you can quickly delete the diagram from your model. This has no effect on the elements shown in the diagram - they and their relationships remain unchanged within the model, and accessible through the Browser window and several other views and windows.

Access

Context Menu	Browser window Right-click on diagram name Delete '<diagram name>' A confirmation prompt displays. Click on the Yes button to confirm the deletion.
Keyboard Shortcuts	Select diagram in Browser window Ctrl+Del A confirmation prompt displays. Click on the Yes button to confirm the deletion.

Notes

- In Enterprise Architect there is no 'Undo' feature for

deleting diagrams, so be certain that you want to delete a diagram before you do so

- In the Corporate, Unified and Ultimate Editions of Enterprise Architect, if security is enabled you must have 'Manage Diagrams' permission to delete diagrams
- You can also delete multiple diagrams from the Browser window, by holding Ctrl or Shift while you select them, then right-clicking on one of them and selecting the 'Delete selected items' option

Diagram Tabs

Diagram tabs indicate which diagrams and views (such as the Start Page, document reports, code editors and the Model Search) are currently open in the work area, by showing the view name and icon. The currently displayed view is indicated by the name being in bold on a white tab. An asterisk against the tab name indicates that the diagram or view contains unsaved changes.

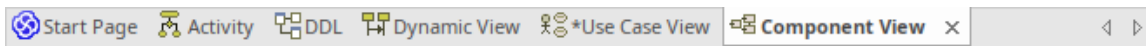

To open the view that you want, click on its tab. You can select options for saving, reloading, moving and closing the views from the tab context menu. You can also review the tabs and select one using the View Tab Switcher window. The tabs are located, by default, at the top of the Diagram View; if you prefer, you can move them to the bottom of the Diagram View using the 'Application Look' dialog (the 'Main View Tabs at bottom' checkbox).

Access

Context Menu	Right-click on the 'Diagram' tab
Other	The View Tab Switcher window can be accessed by pressing and holding the Ctrl key, while pressing the Tab key.

Diagram tabs context menu options

Option	Action
Save Changes to '<tab name>'	Select this option to save changes made to the diagram or view.
Save All	Select this option to save changes made to the model.
Reload '<tab name>'	<p>Select this option to reopen the diagram or view without the unsaved changes; that is, revert to the state before any of your changes were made.</p> <p>This also refreshes the diagram or view from the repository, to show any changes made by other users in a shared model.</p>
Float	<p>Select this option to convert the diagram or view into a floating window that you can move around your screen(s).</p> <p>An alternative is to simply click on the selected tab and drag it off the 'Diagram Tabs' row.</p> <p>You could use this option to display and</p>

	<p>work on several diagrams at the same time, provided that you have not enabled the 'Open Diagrams in Single Window' option in the 'Application Look' dialog. To restore a floating view to a tab in the Diagram View, right-click on its Caption Bar and select the 'Tabbed Document' option.</p>
Close '<tab name>'	<p>Select this option to close the selected diagram or view; the system prompts you to save any changes.</p> <p>You can also close the tab by clicking the middle mouse button/scroller.</p>
Close All	<p>Select this option to close all open diagrams and views; the system prompts you to save any unsaved changes.</p>
Close All Except '<tab name>'	<p>Select this option to close all diagrams and views except for '<tab name>'; the system prompts you to save any unsaved changes.</p>
Close All <view type>	<p>(Where several views of the same type can be opened at the same time, such as diagrams, report documents, or text editors.)</p> <p>Select this option to close all views of the</p>

	same type as the selected tab, leaving views of other types still open.
Hide	<p>(Start Page only) Select this option to hide the Start Page.</p> <p>To redisplay the Start Page, use the drop-down menu at the top right of the Diagram View, or select the 'Start > Application > Workspace > Show Start Page' ribbon option.</p>

Notes

- You can change the sequence of tabs by clicking on each tab and dragging it to a different position, as required; however, you cannot change the position of the 'Start Page' tab - when displayed, it always sits at the left-hand end of the sequence
- If you have enabled the 'Open Diagrams in Single Window' option on the 'Application Look' dialog, you can open only one diagram at a time; however, you can scroll back through previously opened diagrams by clicking on the diagram tab and pressing the Backspace key
- One of the strengths of Enterprise Architect is that you can work in one of the central views (the 'active' view) and instantly display and edit aspects of your model in one or more of the windows surrounding the view; having

completed your review in a window, however, you can quickly switch focus back to the object you were working on in the active view by pressing Ctrl+Shift+` (effectively Ctrl+~)

- The only context menu option available for the 'Start Page' tab is the 'Hide' option

Switch Between Views

When there are a number of open views available in the Diagram View (such as separate diagrams, editors and the Model Search screen), you can review them and switch between them using the View Tab Switcher.

Access

Other	Click on a view tab, press and hold Ctrl while you press the Tab key.
-------	---

Switching between views

Action	Detail
Selecting a different view	

Domain Model

Active Views

- PlayerFactory.java
- Domain Model**
- Use Cases
- Team Review
- User Interface
- Action
- ICombatEventListener.java
- Start Page

Domain Model
Rule Model Diagram

Rule Model Diagram: "Domain Model"

The View Tab Switcher lists the currently open views, in order of most recently activated to least recently activated; the selection cursor is on the name of the view that was activated just before the currently active one.

Details of the selected view are displayed on the right hand side of the screen, and include:

- A preview thumbnail of the view, and
- A description of the view and its contents

Continue holding the Ctrl key to keep the window open; to move the selection cursor:

- Down the list of views, press the Tab key
- Up the list, press the Shift+Tab keys

	Alternatively, use the arrow keys.
Activating a view	<p>To activate a view in the Diagram View, either release the Ctrl key or press the Enter key; alternatively, click on the required view.</p> <p>Activating a view moves it to the top of the 'Active Views' list, whereas closing a view removes it from the list completely.</p>

Notes

- One of the strengths of Enterprise Architect is that you can work in one of the central views (the 'active' view) and instantly display and edit aspects of your model in one or more of the windows surrounding the view; having completed your review in a window, however, you can quickly switch focus back to the object you were working on in the active view by pressing Ctrl+Shift+` (effectively Ctrl+~)

Diagram Toolbox

The Diagram Toolbox is a panel of icons that you can use to create elements and connectors on a diagram. You can also use the Toolbox to add elements to:

- A Package through the Specification Manager and
- A Package or an element in the Browser window

Within the Toolbox, related elements and connectors are organized into pages, each page containing the elements or connectors used for a particular type of diagram. The diagrams include standard UML diagrams, Enterprise Architect Extended diagrams, and diagrams customized for any MDG Technologies and Profiles that you have added to the system.

When you open a diagram, the Toolbox automatically provides the element and relationship pages corresponding to the diagram type. This does not prevent you using elements and connectors from other pages in a given diagram, although some combinations might not represent valid UML.

The Toolbox provides a number of mechanisms for locating the page or object you want to use.

Access

Ribbon	Design > Diagram > Toolbox

Keyboard Shortcuts	Ctrl+Shift+3
Other	You can display or hide the Diagram Toolbox by clicking on the » or « icons at the left-hand end of the Caption Bar at the top of the Diagram View.

Example

For any given diagram a number of Toolbox pages might display, but these generally include:

- <type> Elements
- <type> Relationships
- <type> Patterns
- Common Elements
- Common Relationships and
- Several groups of Artifacts

This is illustrated in the example:

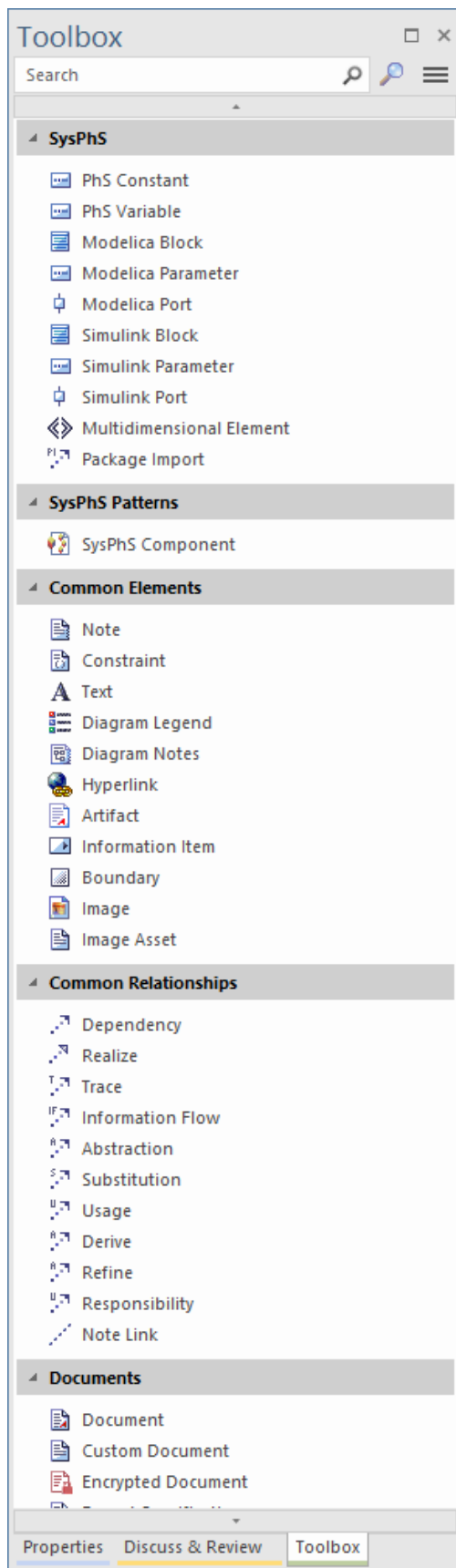

Locating Diagram Toolbox Pages or Icons

These options help you to locate and display particular pages or icons in the Diagram Toolbox

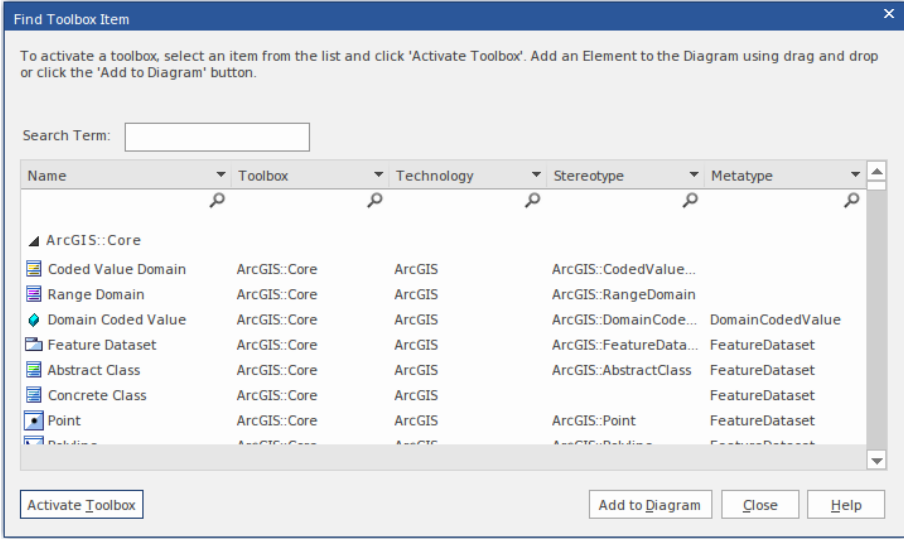
Option	Detail
<p>Search for a Toolbox page or icon</p>	<p>The easiest way to locate a Toolbox page or specific icon that you require is to use the 'Find Toolbox Item' dialog, which you display by clicking on the  button at the top of the Toolbox. The 'Find Toolbox Item' dialog displays every Toolbox page, listed by Technology name and page name, in alphabetical order.</p>  <p>The columns that display on this dialog can be added to using the 'Field Chooser' dialog (right-click on the column headings and select the 'Field Chooser' option), and dragged into a different sequence. You can also select options to</p>

use the 'Group Box' to reorganize the display of information in the dialog, and to expand or hide the contents of every Diagram Toolbox page. You can expand the Toolbox pages individually by clicking on the white arrowhead to the left of the page name.

To locate a Toolbox page or icon, you can type some or all of the characters in the name or property of the object you are searching for in either:

- The 'Search Term' field or
- The appropriate Filter bar field underneath each column header (right-click on the column headers and select the 'Toggle Filter Bar' option) or
- 'Search Term' and Filter bar fields in combination to further refine the search

As you type, the list immediately reduces to show only the objects that have those characters in their name or property text.

Be aware that if you have the list collapsed, showing only the Toolbox page name, the list might show page names that do not include the characters. Those pages do contain objects that have those characters. The search automatically selects the first object in the list; to move to the next object, press

the Down Arrow key.



To confirm what the object is that you have positioned the cursor on (especially if you do not want to use all the columns available in the 'Field Chooser' dialog) the stereotype and page name for the object display in the bottom left corner of the dialog.

Having located the Toolbox page or object you require in the dialog, you click on the Add to Diagram button or drag the objects onto an open diagram to generate elements or connectors. You can also drag element icons into the Specification Manager to generate elements there.

If you want to refresh the Diagram Toolbox to display the Toolbox page you have selected, so that you can use all the icons in it during this session, either:

- Click on the Activate Toolbox button, or
- Double-click on a page name or an object in the 'Find Toolbox Item' dialog, or
- Right-click on an object in the list and select the 'Show Toolbox' option

The context menu also provides options to

	<ul style="list-style-type: none"> • Pin the Toolbox page to the Diagram Toolbox so that it is always included there until it is specifically unpinned • Move the cursor to the first Filter Bar field ('Name') to edit it • Hide the Filter Bar • Expand or collapse all the Toolbox pages displayed in the dialog
<p>Search for an icon on the current Toolbox page</p>	<p>To locate an element or link on the currently-displayed Toolbox pages, simply overtype the <i>Search</i> field at the top of the Toolbox with some or all of the characters of the object name. The field filters the pages to show only those objects that have those characters in their names.</p> <p>To clear the field, click on the  icon or press the Delete key or Backspace key. This facility is very useful if you have long pages of elements or several pages pinned in the Toolbox (see the <i>Customize the Toolbox</i> section).</p>
<p>Filter Pages by Perspective</p>	<p>Click on the  icon at the right of the Toolbox toolbar. This displays a list of Toolbox pages, filtered for the currently-selected Perspective. To set or change the Perspective, select the</p>

'Change Perspective' option at the top of the menu. This displays the list of Perspective Groups; click on these to show a submenu of Perspectives, and select the required Perspective.

In some cases the list of Toolbox pages might be of page groups that you select to list the pages themselves. Scroll through the lists to find the name of the pages you want. If the list is very long, you can scroll using the mouse wheel or up arrow and down arrow keyboard keys, or by clicking on the small black arrows at the top and bottom of the list window. Click on the required name to display the pages in the Toolbox.

If you select the <default> option, at the top of the list, you display only the 'Common' and 'Artifact' pages.

You can pin various pages in the Toolbox to customize it, showing the elements and relationships you most commonly use for the types of diagram you model with, and you can add MDG Technologies and UML Profiles to the Toolbox under their own Perspectives.

Create elements and connectors on the diagram from the Toolbox

Step	Instruction
1	<p>In the Browser window, double-click on the icon against the required diagram.</p> <p>The diagram opens with the appropriate Toolbox pages for that diagram type.</p> <p>If you want a different set of elements and connectors, select the appropriate Toolbox pages as explained previously.</p>
2	<p>Click on the icon for the required item; for example, the Class element or Associate relationship.</p>
3	<p>For element items, click anywhere on the diagram to place the new element at the cursor position.</p>
4	<p>For connector items, drag the cursor between the source and target elements on the diagram; as you pass the cursor over the elements, a hatched border displays inside each element's solid border, indicating the source and potential target elements.</p> <p>To add bends to the connector, press Shift as you change the drag direction of the cursor.</p>

	Alternatively, drag from the source element to an empty area of the diagram; the Quick Linker suggests common target element types and connector types to create.
5	Edit the element properties or connector properties, as required.

Create elements in the Browser Window

Click on the element icon in the Diagram Toolbox, then click on the parent Package or element in the Browser window to select it, and click again to drop the element under the parent.

You cannot add objects that do not display in the Browser window, such as Note elements, Text elements, connectors or Boundaries.

If an element is of a type that cannot be added as a child of the object in the Browser window, an error message displays.

Notes

- Dropping a Package icon from the Toolbox into a diagram creates a new Package in the Browser window, and a default diagram of the same type as the current diagram
- If you are creating several elements of one type, after

creating the first just press Shift+F3 or Ctrl+click to create the next element of that type; for connectors, click on the source element and press F3 to create another connector of the same type

- You can change an unstereotyped element to one of its stereotyped elements by dragging the stereotyped element icon from the Toolbox onto the unstereotyped element in the diagram; for example, you can stereotype a Class by dragging a Table icon or a Profiled Class icon onto it
- As you drag the stereotyped element icon, you can press Ctrl to apply the element stereotype to the unstereotyped element, or Shift to add the stereotyped element as a new element; otherwise a small context menu displays offering these actions as options
- If the diagram element already has the stereotype, you can also drag the Toolbox icon onto it to synchronize the element's stereotype Tagged Values
- The Toolbox can be docked on either side of the diagram, or free floated on top of the diagram to expose more surface for editing; you can also hide and redisplay the Toolbox by clicking on the horizontal 'chevron' icon at the left of the diagram header bar
- Enterprise Architect provides Toolbox pages for a wide range of MDG Technologies, such as ArchiMate, BPEL, BPMN, Data Flow diagrams, ICONIX and Mind Mapping, as part of the initial install

Toolbox Appearance Options

You can modify the appearance of the Diagram Toolbox pages in several ways, through the Toolbox context menu.

Access

Other	Right-click on a Toolbox page background
-------	--

Options

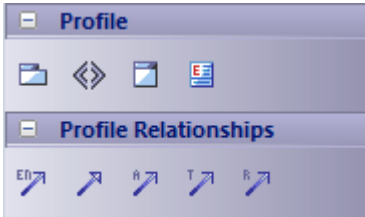

Option	Detail
Hide or Show Element or Relationship Name Labels	<p>Select the 'Hide Labels' (or 'Show Labels') context menu option.</p> <p>The icons in the page then 'wrap' within the page, without text labels.</p>  <p>When you hide the labels, you can display the label of an individual element or relationship by moving the cursor over</p>

	<p>the icon.</p>
<p>Pinning Individual Pages to Display All the Time</p>	<p>Select the 'Pin in Toolbox' context menu option.</p> <p>For example, if you 'pinned' the expanded 'Class' page, and switched to the 'Communication' pages, the Toolbox would include a collapsed 'Class elements' page below the 'Communication' pages.</p> <p>You can also pin a 'SysML Common' page to the Toolbox, simply by making the SysML 1.4 Technology the Active technology for your work login.</p> <p>These Toolbox pages are automatically pinned and cannot be unpinned:</p> <ul style="list-style-type: none"> • Common Elements • Common Relationships • Documents • Governance • Dynamic Viewpoints • Charts • Simulation
<p>Unpinning Pages</p>	<p>To unpin the expanded page so that it displays only in its own Toolbox group, select the 'Unpin from Toolbox' context menu option. This applies to pages</p>

	<p>pinned from the context menu or through the 'Pinned Toolbox Pages' dialog (see the <i>Tailor Toolbox to List all Required Pages at Once</i> table).</p>
Collapsing Pages	<p>To collapse a page to just show the heading (such as 'Class', 'Documents' or 'UML Standard Profile'), select the 'Collapse the current branch' option. Alternatively, click on the page name. To expand the page again, click on the page name.</p>
Setting a Toolbox Page as the Package Default	<p>You can set a Toolbox page to be shown whenever a specific Package is selected in a view such as the Specification Manager.</p> <p>Click on the Package in the Browser window, then locate and select the required page in the Diagram Toolbox. Either:</p> <ul style="list-style-type: none">• Right-click on the Toolbox page or• Click on the page header and click on the Hamburger icon <p>Now click on the 'Set as Package Default' menu option. An <code>SSDefaultToolbox</code> tag is added to the current Package, with the fully qualified name of the current Toolbox page as its value.</p>

	<p>The Toolbox page will now be loaded into the Toolbox as the default whenever the Package is selected in the Specification Manager or other view.</p>
--	---

Tailor Toolbox to List All Required Pages at Once

Step	Instruction
1	<p>On the context menu, click on the 'Set Toolbox Visibility' context menu option. (This option is also displayed in the  drop-down menu.)</p> <p>The 'Pinned Toolbox Pages' dialog displays, showing all the Toolbox pages available under the currently-selected Perspective.</p> <p>Initially, the currently-selected Perspective is the global perspective identified on the  <perspective name> icon at the top right of the application screen. Click on the <perspective name> button at the top of the dialog and select the Perspective Group and Perspective most appropriate to the area you are working in. If you want to examine diagrams across the model from any Perspective, select the 'All' option.</p>

	<p>Changing the Perspective in the 'Pinned Toolbox Pages' dialog does not change the 'global' perspective on the icon. If you want to re-set the 'Pinned Toolbox Pages' dialog Perspective to the global Perspective, simply click on the <perspective name> button and select 'Active'.</p>
2	<p>By default, the dialog lists the element pages only, in alphabetical order.</p> <p>To include the corresponding relationship pages, select the 'Show Relationship Pages' checkbox at the bottom of the dialog.</p>
3	<p>For each page to display on the Toolbox, select the 'Pinned' checkbox.</p> <p>Deselect the checkbox if you no longer require a page to be displayed.</p>
4	<p>When you have defined the list of pages to display, click on the OK button.</p> <p>The pages you have selected are pinned to the Toolbox in a collapsed state, underneath the current diagram-type pages.</p>

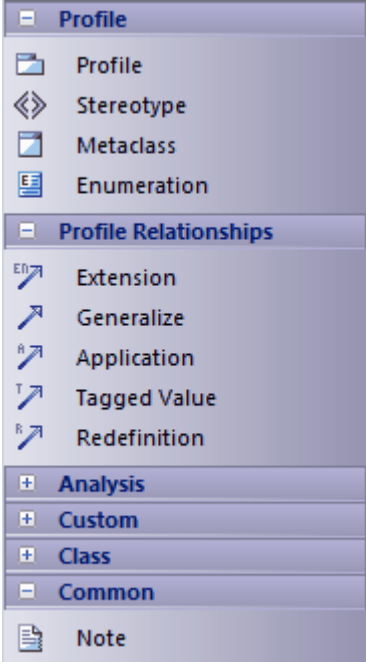
	 A screenshot of a software toolbox menu. The menu is organized into several sections. The top section is titled 'Profile' and contains four items: 'Profile' (with a folder icon), 'Stereotype' (with a double-headed arrow icon), 'Metaclass' (with a document icon), and 'Enumeration' (with a list icon). The next section is titled 'Profile Relationships' and contains five items: 'Extension' (with an arrow icon), 'Generalize' (with a double-headed arrow icon), 'Application' (with a double-headed arrow icon), 'Tagged Value' (with a double-headed arrow icon), and 'Redefinition' (with a double-headed arrow icon). Below these are four more sections, each with a plus sign icon: 'Analysis', 'Custom', 'Class', and 'Common'. At the bottom is a 'Note' section with a document icon.
5	<p>To expand a page, click on the heading.</p> <p>To remove an individual page, expand it, right-click on it, and select the 'Unpin from Toolbox' option.</p>

Notes

- On a Toolbox page for an MDG Technology or UML Profile, if you right-click directly on a Profile element an additional option - 'Synchronize Stereotype' - is available at the end of the context menu; this enables you to synchronize the Tagged Values and constraints for all elements created from the selected Profile element
- MDG Technologies can impose their own Toolbox page visibility; for example, if ICONIX is the active technology, all six ICONIX pages are automatically exposed in the Toolbox

- If the active Technology pages duplicate UML or Extended pages (as the ICONIX pages do), the pinned Technology pages override and replace the pinned UML and Extended pages; for example, if ICONIX is active and you have pinned the 'Extended | Analysis' page, the 'Analysis' page in the list is the ICONIX-defined page, not the 'Extended | Analysis' page

Toolbox Shortcut Menu

When you add elements and connectors to a diagram, you can do so using the 'Toolbox Shortcut' menu as an alternative to employing the full graphical Toolbox.

The menu resembles this example:

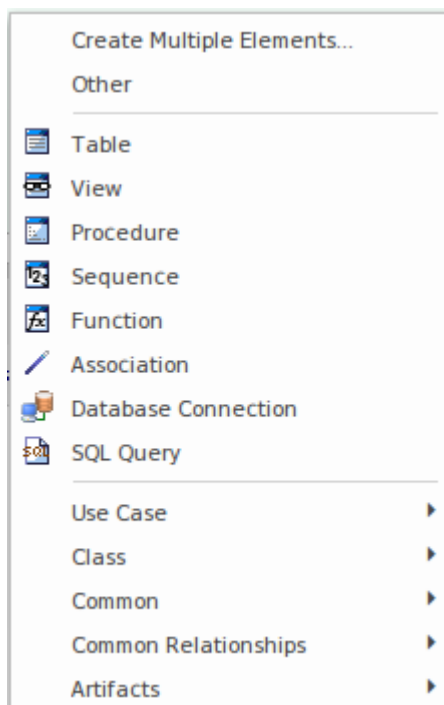

It provides options to add to the diagram:

- Multiple elements at once, of types appropriate to the diagram or selected Toolbox page
- Elements and connectors from Toolbox pages assigned to other diagram types (the 'Other' option)
- Elements and relationships specific to the current diagram type (in the example, the Database elements)
- Elements and relationships from any pages pinned in the Toolbox (in the example, the 'Use Case' and 'Class' options)

- Common elements and relationships
- Artifacts of any type

The advantage of using the shortcut menu is that it provides an increased amount of the workspace to be used for diagramming rather than displaying fixed (instead of pop-up) menus.

Use the Toolbox Shortcut Menu

Step	Action
1	Open a diagram.
2	Click on the diagram background and press the Insert key or Spacebar or, using the mouse, hold the left button and click the right button. The 'Toolbox Shortcut' menu displays.
3	If you want to: <ul style="list-style-type: none"> • Create a group of elements in one go, select the 'Create Multiple Elements' option to display the 'Create Multiple Elements' dialog, or • List elements and connectors for a different diagram type, either: <ul style="list-style-type: none"> - Select a pinned Toolbox page option, or - Select the 'Other' option to display the 'Find Toolbox Item' dialog and search for the

	<p>appropriate element or toolbox page</p> <ul style="list-style-type: none">• Add a common element or an Artifact element, expand the appropriate option
4	<p>Click on the element or connector to include in the diagram; the element is added to the diagram, or you can drag from one element to another to create the connector.</p> <p>If you select the 'Other' context menu option, the 'Find Toolbox Item' dialog offers the 'Activate <Type> Toolbox' option; this opens and activates the corresponding page in the Toolbox.</p>

Notes

- As with the Toolbox itself, if an MDG Technology:
 - Is active
 - Automatically pins Toolbox pages, and
 - Duplicates UML or Extended pagesthen the pinned Technology pages override and replace the pinned UML or Extended pages in the 'Toolbox Shortcut' menu

Add Multiple Elements

Enterprise Architect provides a facility for quickly creating a number of elements to be added to a diagram in one go. This helps you to organize a set of elements - all the same type or a mixture of types - and review them, renaming or deleting some if necessary, before committing them to the diagram and model. One of the very useful features of this facility is that you can import a block of lines of text and automatically create a new element from each line. You can use this to generate a large number of, say, Requirement or Business Rule elements with meaningful names, from a source document such as a spreadsheet or specification in an instant.

You set up the group of new elements using the 'Create Multiple Elements' dialog.

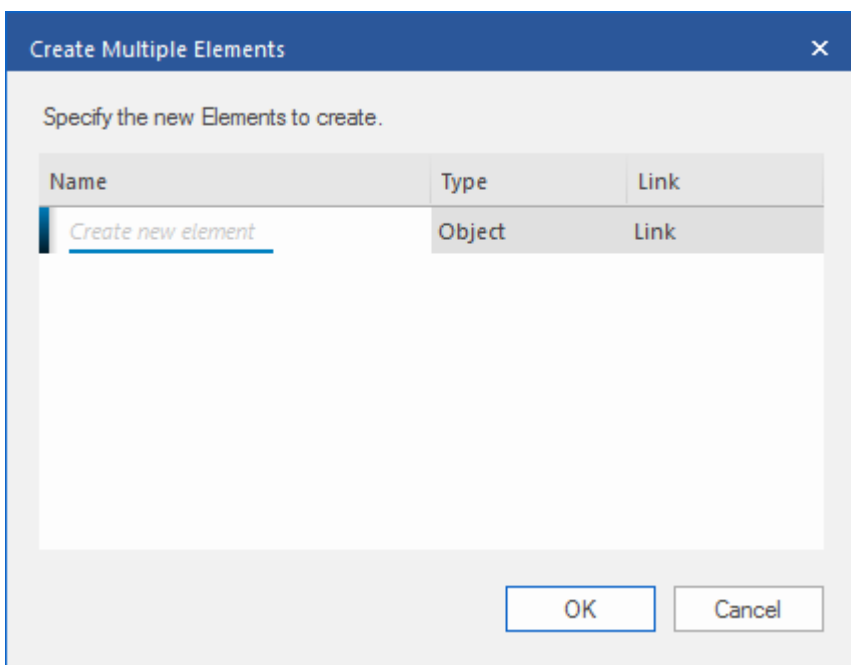

There are two variants of this dialog. You can create:

- Separate elements through one of a number of keyboard commands, in which case the dialog shows the 'Name' and 'Type' columns, or
- Elements related to one selected element using the Quick Linker arrow, in which case the dialog also provides a 'Link' column (as shown) through which you specify what the relationships are between the selected element and the new elements

Access

On an open diagram:

Ribbon	Design > Element > Add Element > Multiple Elements
Keyboard Shortcuts	Insert key > Create Multiple Elements Space Bar > Create Multiple Elements Ctrl+right-click > Create Multiple Elements Shift+right-click > Create Multiple Elements
Other	Drag an element's Quick Linker arrow to an open space on the diagram and release the mouse button > Create Multiple Elements

Create the group of elements

On the 'Create Multiple Elements' dialog:

Step	Action
1	In the 'Name' column, overtype the <i>Create new element</i> text with the name of the new element.
2	<p>In the 'Type' column, click on the drop-down arrow at the right of the field and select the required element type.</p> <p>The types offered in the drop-down list are those currently listed in the Toolbox selected for the diagram (or, if you selected the option with the Quick Linker arrow, the types are the same as those in the Quick Linker list).</p>
3	<p>Selecting the type positions the cursor on the next line, with the 'Type' field set to the same element type as you selected from the previous element.</p> <p>You can simply type in the next element name and press the Enter key to create another element of the same type, or type in the name and repeat Step 2 to add an element of a different type.</p>
4	If you have displayed the 'Create Multiple Elements' dialog from the Quick Linker arrow menu, the dialog

	<p>displays a 'Link' column for the type of relationship between the selected element and each new element. Click on the drop-down arrow and select the relationship type from the list; the list is the same as that provided by the Quick Linker, and consists of the appropriate common relationships for the source and element types.</p> <p>The first selected relationship sets the default for the next relationship you create on the dialog, and you can either leave that as it is or select a different type.</p>
5	<p>When you have specified a complete set of elements and relationships, you can quickly review and - if necessary - modify them using a context menu within the dialog (see the <i>Review New Elements</i> table) before you commit them to the diagram and model.</p> <p>When you are satisfied that you have defined the objects you require, click on the OK button to add them to the diagram and model.</p> <p>If the linked elements need to have other structures (such as the Object Flow link between an Activity and an Action) these are also added (in this case, an ObjectNode on the Activity and an ActionPin on the Action).</p>
6	<p>If you decide not to create elements from the names you have entered, press the Cancel button to delete them all and to close the dialog.</p>

Review New Elements

Right-click on an item in the list, to display the context menu.

Op tio n	Action
A dd N e w E l e m e n t	<p>Position the cursor in the next empty 'Name' field, ready for you to type in an element name. The 'Type' and 'Link fields' default to the values from the previous entry.</p> <p>Shortcut: Ctrl+N</p>
E dit I t e m	<p>Place the selected element name in Edit mode, to be typed over with a different name.</p> <p>You can also change the name, element Type and Link type by clicking on the field and overtyping or selecting a new value from the drop-down list.</p> <p>Shortcut: Enter key</p>



<p>Delete item</p>	<p>Immediately remove the selected item from the dialog. The element does not and will not exist in the diagram and model, and therefore will not have any links to other elements, Packages or diagrams to check. There is no validation to establish whether to delete the element from the diagram only, or from the diagram and model. Shortcut: Ctrl+D</p>
<p>Import Names from Clipboard</p>	<p>Insert a number of lines of text from the Windows clipboard, each line becoming the name of a new element. The element Type and Link type default to the last-defined types, which you can leave as is or change as required. If the dialog is too narrow to display the element names, you can resize it. The imported text can come from an internal or external file. The system takes any line break (Enter, Shift+Enter, Ctrl+Enter) as the end of the text string and hence the end of the element name.</p>



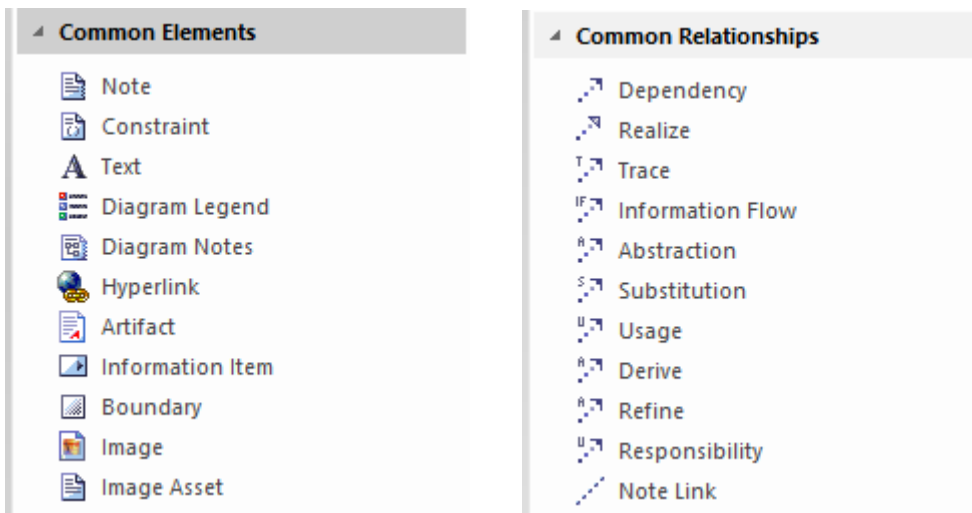

Common Pages



The 'Common' pages of the Diagram Toolbox provide the elements and relationships that can be used on any diagram. They are displayed at the bottom of every other set of pages in the Toolbox.





Common Elements







Element	Description
 Note	A Note element is a textual annotation that can be attached to a set of elements of any other type.
 Constraint	A Constraint is a form of Note, identifying a constraint on other elements.
 Text Element	A Text element is a textual annotation



	that is similar to a Note, however has no border or background color.
 Diagram Legend	A Legend element provides a key to the colors and line thicknesses you have used to distinguish between element and/or connector groupings on the diagram.
 Diagram Notes	On a diagram, it is possible to display a customized text box called the Diagram Properties Note, which automatically shows the diagram properties.
 Hyperlink	A Hyperlink element is a special kind of Text element that, when double-clicked, opens the configured target object such as a document, web page or diagram.
 Artifact	An Artifact is any physical piece of information used or produced by a system. This icon generates a generalized Artifact that you can define as one of a number of types. There are also Toolbox pages providing specialized types of Artifact, for specific purposes. See the Artifact Toolbox Pages Help topic.
 Information Item	An Information Item element represents an abstraction of data, which data can be

	conveyed between two objects.
 Boundary	A System Boundary element is a non-UML element used to define conceptual boundaries.
 Image	An Image is a System Boundary element that automatically has an Alternate Image defined.
 Image Asset	An Image Asset is a specialized Artifact element for holding an image that can be called into a number of diagrams to show a captured document or screen, a graphic, or an object.

Common Connectors

Connectors	Description
 Dependency	Dependency relationships are used to model a wide range of dependent relationships between model elements.
 Realize	A source object implements or Realizes its destination object.

 Trace	<p>The Trace relationship is a specialization of an Abstraction, connecting model elements or sets of elements that represent the same concept across models.</p>
 Information Flow	<p>An Information Flow represents the flow of Information Items (either Information Item elements or classifiers) between two elements in any diagram.</p>
 Abstraction	<p>An Abstraction is a relationship between two elements that represent the same concept, either at different levels of abstraction or from different viewpoints.</p>
 Substitution	<p>A Substitution is a relationship between two Classifiers, signifying that the substituting Classifier complies with the contract specified by the contract Classifier.</p>
 Usage	<p>A Usage is a Class diagram relationship in which one element requires another element for its full implementation or operation.</p>
 Derive	<p>A Derive relationship connects two elements when the value of one is derived</p>

	<p>from the value of the other. This type of relationship is appropriate to link Requirements on different levels of abstraction; for example, a solution Requirement derived from a business or a stakeholder Requirement.</p>
 Refine	<p>A Refine relationship connects a Requirement and another model element that adds refinement or additional information that helps clarify the Requirement so that its meaning is more apparent.</p>
 Responsibility	<p>A Responsibility connector is a UML standard stereotype that defines a contract or an obligation of an element in its relationship to other elements.</p>
 Note Link	<p>A Notelink connector connects a Note to one or more other elements of any other type.</p>

Artifact Toolbox Pages

An Artifact is any physical piece of information used or produced by a system. In Enterprise Architect these are represented by the Artifact element, which can have one of a number of stereotypes to tailor it to a specific purpose, including internal operations and structures within the model as indicated in the examples. Artifacts can have associated properties or operations, and can be instantiated or associated with other Artifacts according to the object they represent. You can create an Artifact element by dragging an Artifact icon from one of several Diagram Toolbox pages, according to type.

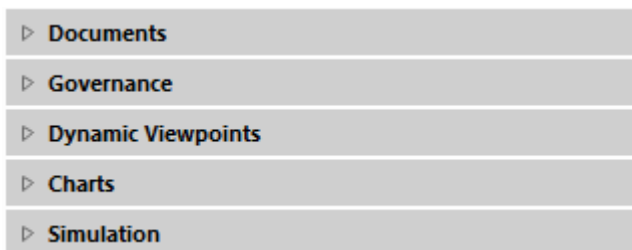

The 'Common Elements' page of the Toolbox also has a generic Artifact icon that - when you drag it onto a diagram - offers a choice of types of Artifact to create.

Documents Toolbox

The 'Documents' page of the Diagram Toolbox provides a variety of model elements to use for documenting various aspects of the system you are modeling. The different types of document artifact are detailed in the *Types of Document Artifact* table.

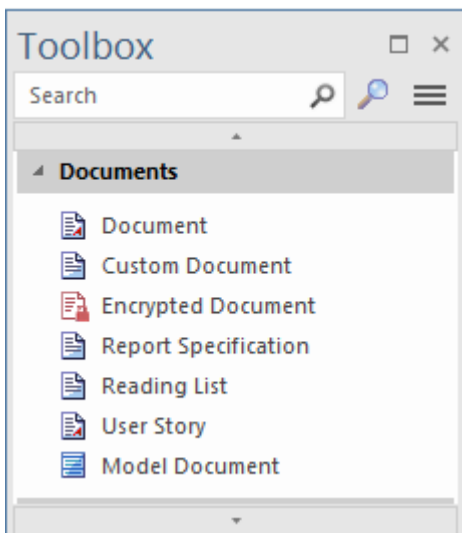

Types of Document Artifact



Type	Description
Document Artifact	A Document Artifact is an Artifact having a stereotype of «document». You can create the Document Artifact using the Documentation, SysML or Zachman Framework pages of the Diagram

	<p>Toolbox, and associate it with an RTF document or CSV file.</p> <p>Double-click on the element to display the Linked Document Editor. When you have created the Linked Document, the Document Artifact element on the diagram shows an 'A' symbol in the bottom right corner.</p>
Custom Document Artifact	<p>A Custom Document is a form of Linked Document, and therefore is associated with an element in the model. However, Linked Documents usually contain static information specific to the host element, whereas the main feature of a Custom Document is that it contains automatically refreshed information on several objects from anywhere in the model. Therefore, the main method of creating a Custom Document also generates a Document Artifact element to host the document, in a selected Package.</p> <p>A Custom Document Artifact represents a document that is made up of a range of model elements and their properties, where every time you open the document the content is dynamically refreshed from the model objects you have included and from the template instructions.</p>

	<p>A custom document can have three types of content:</p> <ul style="list-style-type: none"> • Content contained in the document template - including a title page, table of contents and paragraph text • Dynamic Content that is dragged into the document from the Browser - including Packages, diagrams, elements and features • Static Content that a user types or pastes into the document <p>For example, at any point in the document where a diagram is needed or a list of items is required that exist in the model, these can simply be dragged in from the Browser window. How these items are rendered is determined by the selection of an appropriate document template.</p>
<p>Encrypted Document Artifact</p>	<p>An Encrypted Document Artifact is used to create and hold a Linked Document that is automatically encrypted, and that cannot be opened and automatically decrypted within Enterprise Architect without entering a password. You can therefore use the generated Artifact element to record sensitive information, which you protect from general access by</p>

	<p>assigning a password.</p> <p>When you drag the 'Encrypted Document' icon onto the diagram from the 'Documentation' page of the Toolbox, a prompt displays to type in a password. When you enter the password, you can create the Linked Document. Thereafter, if any user attempts to open the document, the same password prompt displays. If the user does not provide the password that you originally specified, the document will not open. If the correct password is provided, the document is decrypted and opened.</p> <p>The Encrypted Document Artifact is indicated in the Toolbox page, diagram and Browser window by a red 'document' icon - .</p>
Report Specification Artifact	<p>A Report Specification Artifact encapsulates a report definition. When you have created the element on the diagram, you double-click on it to display the 'Generate Documentation' dialog, on which you enter the report parameters and, if required, generate the report.</p> <p>After you create the Report Specification, each time you double-click on the Artifact element the 'Generate</p>

	<p>Documentation' dialog again displays with the same report parameters. You can continue to generate the same report, or alter the parameters if necessary. If you change the parameters, they are re-presented until such time as you change them again.</p>
Reading List Artifact	<p>The Reading List Artifact provides a list of elements that contain information of particular significance to a task or process. The intention is for the information from each element to be displayed in the 'Dynamic Document' view, in the sequence in which the elements are organized in the Reading List.</p>
User Story Artifact	<p>A User Story Artifact provides a means of documenting a business Use Case, in the context of Agile methodologies such as Extreme Programming (XP). In the Linked Document, you define the functions a business system must provide; it captures the 'who', 'what' and 'why' of a requirement in a simple, concise format. The User Story Artifact behaves as a Document Artifact, prompting you to select a Linked Document template to base the document</p>

	on.
Model Document Artifact	A Model Document Artifact provides a template for developing a Model Document element to generate either a stand-alone virtual document or a section of a virtual document.

Governance Toolbox

The 'Governance' Toolbox page provides icons to create project management elements and Artifacts, to generate Requirement, Maintenance and Review elements and documents and structures to show what development either should be performed or has been performed.

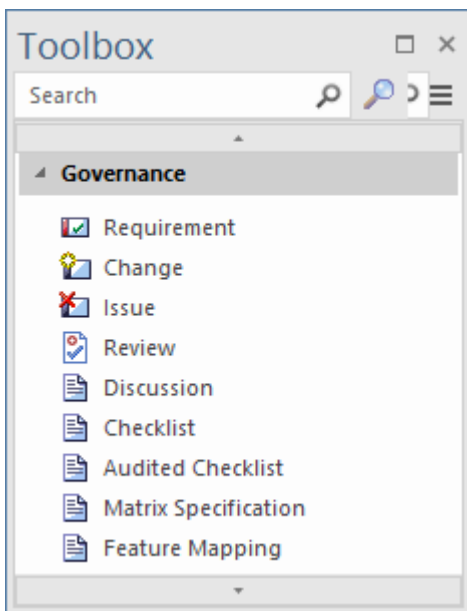

Types of Governance Artifact

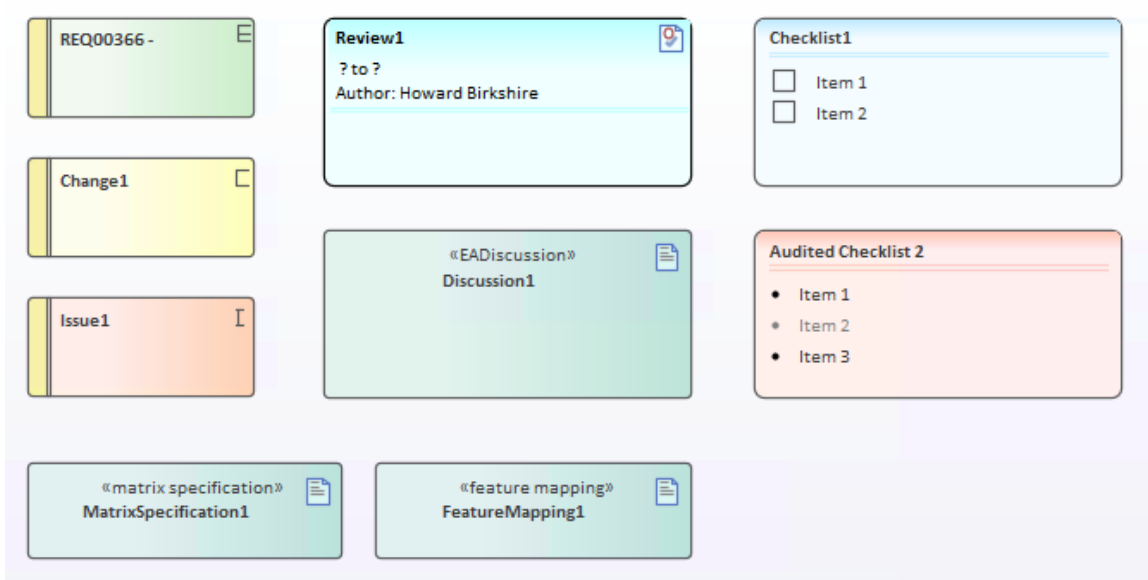

Type	Description
Requirement	A Requirement element captures the details of a system requirement.
Change	A Change element represents a change in the defined requirements for the current system and can be used to request and manage the change process.
Issue	An Issue element represents an item of concern that might or might not arise, or a failure to meet a defined requirement in the current system.
Review	A Review element enables you to define a formal review of a part of the model, in particular a small number of elements and/or diagrams. Each Review element enables you to define when the review should start and end, and which members of the team are responsible for performing the review.
Discussion Artifact	The Discussion Artifact provides a place to host a discussion about a particular part of a model, rather than discussing a specific element. Drag the Discussion Artifact onto a

	<p>diagram where you want to discuss some aspect of the model, and give the Artifact a name. You might want to outline the purpose and scope of the discussion in the Notes and perhaps even add a Linked Document where you record decisions resulting from the discussion.</p>
<p>Checklist Artifact</p>	<p>A Checklist Artifact provides the facility for generating a list of items, each with a checkbox, to be used as a checklist. You can set each checkbox to default to being selected or unselected, and set all selected options to be grayed out or struck through, so that the unselected options are more prominent. The end users can then work with the element to tick off items that have been obtained or activities that have been completed.</p> <p>A version of this Artifact - the Requirements Checklist - is available in the 'Extended Requirements' Toolbox page. This automatically contains ten characteristics of a good Requirement, for a Requirement author to tick off as they check that their Requirement has been set up to show those characteristics.</p>
<p>Audited</p>	<p>The Audited Checklist is an extension of</p>

<p>Checklist Artifact</p>	<p>the Checklist Artifact, having an associated 'Audit Records' page. It is a useful tool for Project Management, providing the facility to monitor accountability and track completion of tasks.</p>
<p>Matrix Specification Artifact</p>	<p>A Matrix Specification Artifact encapsulates a Relationship Matrix Profile definition. When you have created the element on the diagram, you double-click on it to display the 'Matrix Specification' dialog, in which you create the Profile definition. The Profile takes the name of the element. The Profile defined in the Artifact is independent of the Package that contains the Artifact element, and therefore could specify source and target Packages other than the parent Package.</p> <p>After you create the Profile definition, each time you double-click on the Artifact element the Relationship Matrix displays with the Profile applied.</p> <p>To edit the Profile, right-click on the Artifact and select the 'Documentation Edit Matrix Profile' option.</p>
<p>Feature</p>	<p>The Feature Mapping Artifact saves a</p>

Mapping Artifact

profile that represents a particular combination of field values specified in a Feature Matrix.

The Artifact is usually created by clicking the Options button on a Feature Matrix view, then choosing the option 'Profiles | Save as new Profile'. The Artifact is added to the diagram's parent Package as an <<EAFeatureMapping>> Artifact, and the profile name displays at the end of the 'Profiles' sub-menu.

If you drag the icon from the Toolbox page onto a diagram, a Feature Matrix template displays and you can adjust the field values to create the profile. Note that in this context you drag the source and target elements from the Browser window into the 'Source' and 'Target' fields, ensuring that they have relationships between attributes, operations or receptions..

Charts Toolbox

The 'Charts' Toolbox page provides a variety of Chart artifacts to simplify the creation of Charts within your model. Each type of Chart artifact is described in the *Types of Chart Artifact* table.

You can create a new Chart by dragging a Chart artifact from the Toolbox page onto a diagram. Double-click on the new Artifact to open a dialog where you can specify parameters and the data source for the Chart.

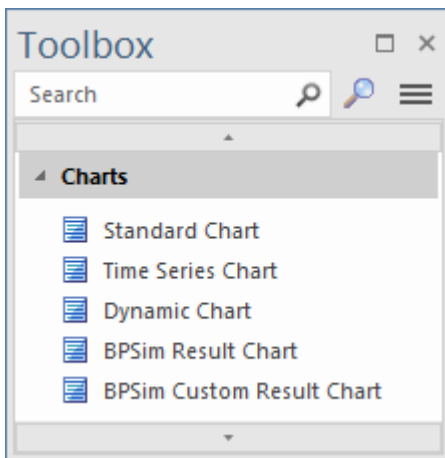

Types of Chart Artifact

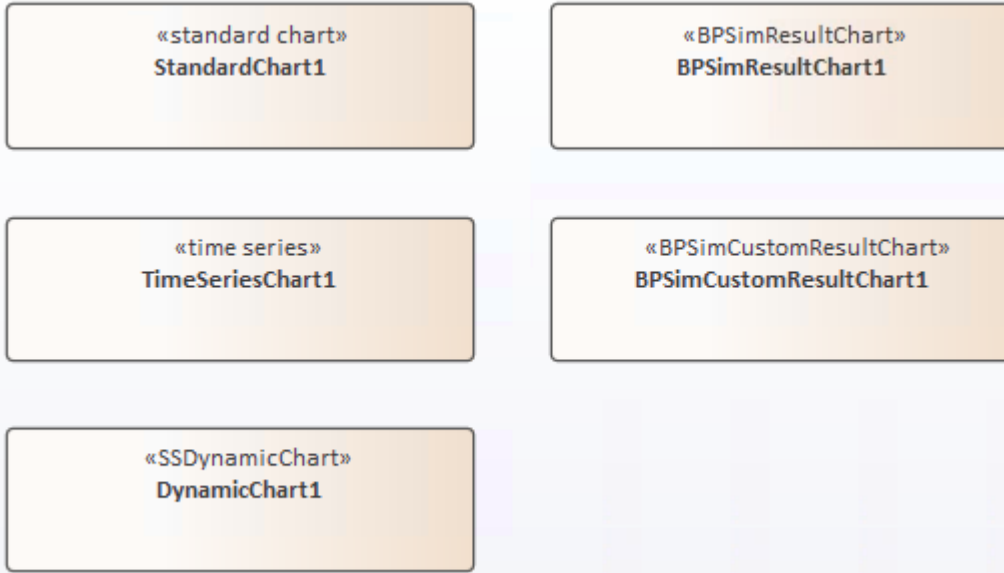

Type	Description
<p>Standard Chart Artifact</p>	<p>A Standard Chart Artifact provides the facilities for generating a Pie Chart or Bar Chart on an aspect of the data in your model. It adds three 'Chart Details' tabs to the standard tabs of the element 'Properties' dialog.</p> <p>After you have added the element to your diagram, double-click on it. The element 'Properties' dialog automatically opens at the 'Chart Details - Source' tab. Define the Chart type and data source, then go on to define any filters you want to apply, and how the Chart should display.</p> <p>Once you have defined the Chart, it automatically displays with the latest information whenever you open the</p>

	parent diagram.
Time Series Chart Artifact	<p>A Time Series Chart Artifact provides the facilities for generating a linear graph of a model property over time.</p> <p>After you have added the element to your diagram, double-click on it. The element 'Properties' dialog automatically opens at the 'Chart Details - Source' tab. Define the Package from which the data is to be extracted, and the time interval over which the data is to be sampled. Then go on to define the appearance of the Chart. Once you have defined the Chart, it automatically displays with the latest information whenever you open the parent diagram.</p>
Dynamic Chart Artifact	<p>Dynamic Chart Artifacts are Chart elements that can be styled and rendered dynamically when the diagram opens.</p> <p>Dynamic Charts rely completely on code to define their series, style and content and are managed entirely through the Automation Interface by clients - typically Plug-ins and scripts.</p>
BPSim Result Chart	The BPSim Result Chart Artifact appears in the 'Charts' page of the Toolbox when

<p>Artifact</p>	<p>the BPSim Simulation Engine has been installed and registered on your system. This Artifact generates a Chart that reflects selected results from a series of standard BPSim Simulations.</p>
<p>BPSim Custom Result Chart Artifact</p>	<p>The BPSim Custom Result Chart Artifact appears in the 'Charts' page of the Toolbox when the BPSim Simulation Engine has been installed and registered on your system. This Artifact generates a Chart that reflects selected results from a series of customized BPSim Simulations.</p>

Dynamic Viewpoints Toolbox

The Dynamic Viewpoints page of the Diagram Toolbox provides a number of elements that actively refresh the interface to Enterprise Architect and the information it displays within various contexts. For example, Working Sets apply a required combination of dialogs and screens, whilst Scriptlets execute JavaScript code to update element displays and properties according to the latest changes to the model data.

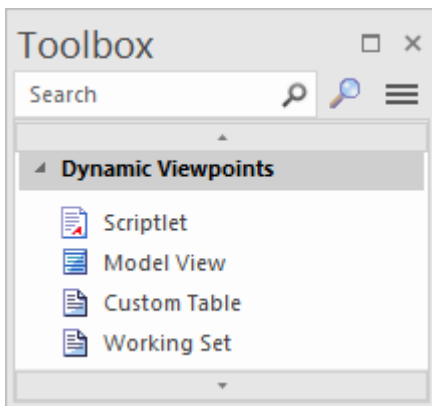

Types of Dynamic ViewPoint Artifact

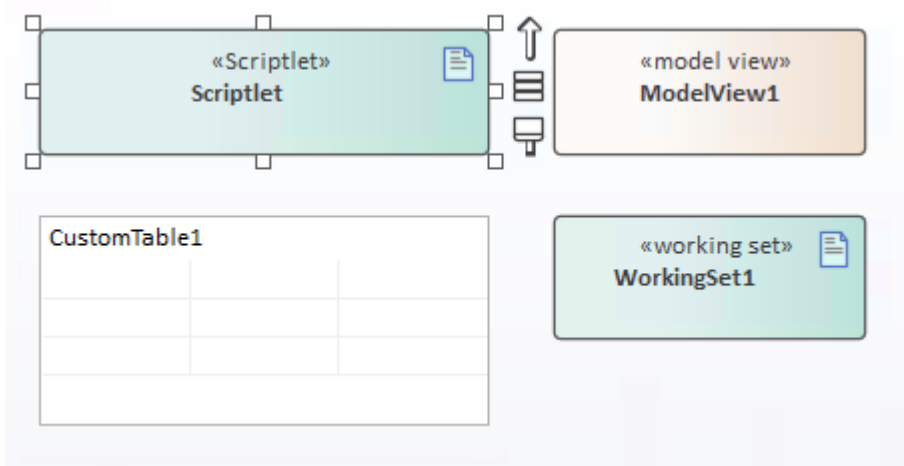

Type	Description

Scriptlet Artifact	<p>A Scriptlet Artifact provides access to Enterprise Architect's API to help you:</p> <ul style="list-style-type: none">• Update Grid style diagrams using the cell reference (A:1, A:2 and so on) through the API• Automate updates to dynamic properties• Apply visual changes to elements, name and Tagged Values• Validate model elements in a diagram• Populate a table• Render graph elements in a dashboard• Dynamically color code elements based on your rules <p>You can have multiple Scriptlets on a diagram and you can use the same Scriptlet on multiple diagrams.</p> <p>Simply drag and drop the Scriptlet icon onto a diagram, then double-click on the element to open the Code Editor. The JavaScript code attached to the Scriptlet is run whenever the diagram is opened. You can also run the Scriptlet code manually as required.</p>
Model View Artifact	<p>A Model View Artifact provides the facilities for generating a tabular Model View Chart on a segment of the data in</p>

	<p>your model, extracted using a custom SQL search.</p> <p>After you have added the element to your diagram, double-click on it. The element 'Properties' dialog automatically opens at the 'Chart Details - Source' tab. Define the SQL Search to extract and tabulate the information.</p> <p>Once you have defined the Chart, it automatically displays with the latest information whenever you open the parent diagram.</p>
<p>Custom Table Artifact</p>	<p>A Custom Table Artifact generates a diagram object that displays custom data in a grid format similar to a spreadsheet, providing extra 'non-modeled' information on elements, diagrams or project management exactly where it is applicable.</p>
<p>Working Set Artifact</p>	<p>A Working Set Artifact defines a Working Set that opens various windows, diagrams and views, recreating a work environment that you frequently use.</p> <ul style="list-style-type: none"> • To create or modify the Working Set, right-click on the element and select the 'Edit Working Set' option • To execute the Working Set to open the

	defined windows and views and execute any commands, double-click on the element
--	---

Simulation Toolbox

The 'Simulation' page of the Diagram Toolbox provides a range of Simulation Artifacts that can be easily created by simply dragging them onto a diagram. Each of the different Artifacts encapsulates specifications or parameters that are required to run the simulation represented by the Artifact.

Each of the Artifact types is described in the *Types of Simulation Artifact* table.

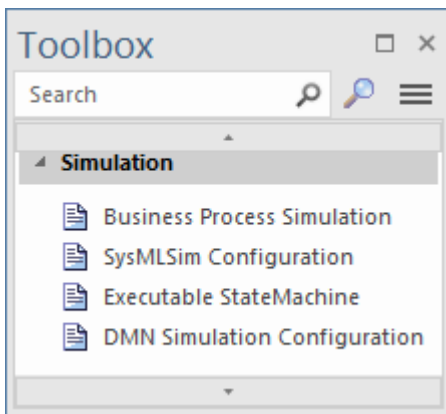

Types of Simulation Artifact

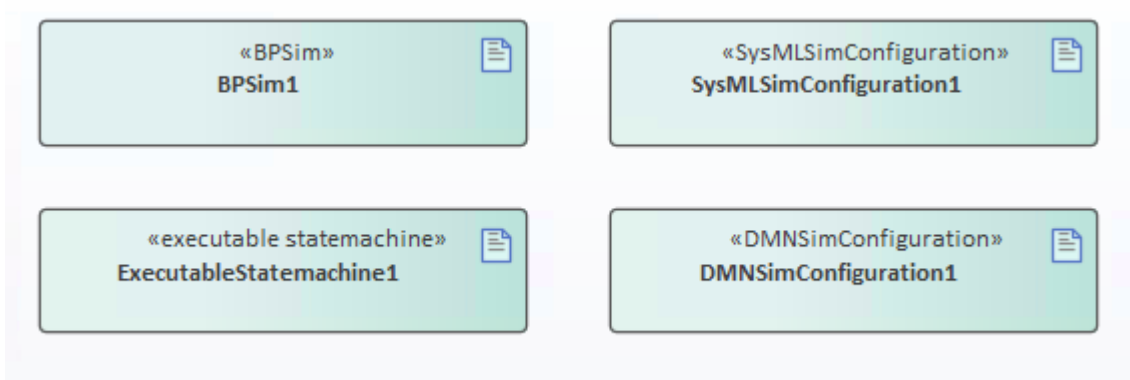

Type	Description
Business Process	A Business Process Simulation Artifact represents and contains the configuration

<p>Simulation Artifact</p>	<p>data for a Business Process Simulation. BPSim Artifacts can be created on a diagram in any Package in the same project as the BPMN model that you are working with.</p> <p>You can specify 'base' and 'variation' Artifacts using Generalization connectors, so that the variations inherit the data you have defined in the 'base' Artifact. This way, you do not have to keep re-defining the whole configuration in every Artifact you create.</p>
<p>SysMLSim Configuration Artifact</p>	<p>The SysMLSim Configuration Artifact encapsulates the run-time parameters for executing the simulation of a SysML model.</p> <p>Double-click the Artifact to display the Configure SysML Simulation window. This window is the interface through which you specify the parameters for the simulation.</p>
<p>Executable StateMachine Artifact</p>	<p>An Executable StateMachine Artifact is the vehicle through which you can generate, build (compile) and execute - via simulation - code for a StateMachine or complex of StateMachines.</p> <p>Each StateMachine is the child of a Class</p>

	<p>element; when you drag the Class from the Browser window onto the Artifact element, it is pasted inside the Artifact as a Part. You can paste several Classes - and, therefore, Parts - into a single Artifact.</p> <p>Having set up the Executable StateMachine Artifact, you use simple context menu options on the Artifact to perform the code generation, build and execution operations on all StateMachines bound within the Artifact.</p>
DMN Simulation Configuration Artifact	<p>A DMN Simulation Configuration Artifact contains information that defines the simulation of a DMN model depicted by Decision Requirement diagrams.</p> <p>Double-clicking on the Artifact opens the DMN Simulation window, from which you can run simulations of the Decision Model, perform validation, generate code and generate test modules.</p>

Use Case Toolbox

The Use Case Toolbox pages are used to model system functionality from the perspective of a system user. Use Case objects are used to build the Use Case models, which describe the functionality of the system to be built, the requirements, the constraints and how the user interacts with the system.

Sequence diagrams can be associated with Use Cases to capture workflow and system behavior.

Use Case Toolbox pages

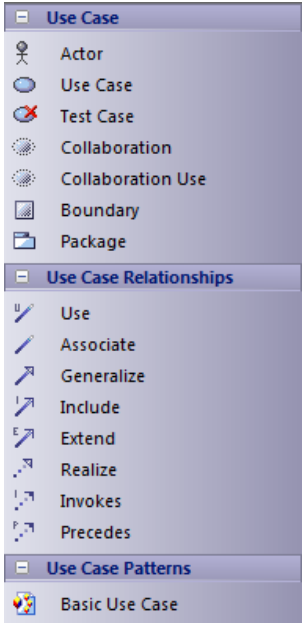
Image	Detail
	<p>Except where discussed here, each element and relationship that you can create using these Toolbox pages is described in the <i>UML Elements</i> and <i>UML Connectors</i> sections of the Help.</p> <p>These two relationships are stereotyped Dependency relationships defined by the OPEN Modeling Language (OML - Object-oriented Process, Environment and Notation Modeling Language - is an international de facto standard object-oriented development method developed and maintained by the OPEN</p>

Consortium). They have been incorporated into the Use Case modeling elements.

- **Invokes** indicates that Use Case A, at some point, causes Use Case B to happen
- **Precedes** indicates that Use Case C must complete before Use Case D can begin

The 'Basic Use Case' icon adds the Basic Use Case Pattern to your diagram as a starting point for developing the diagram (drag the icon onto the diagram to open the 'Add Pattern <name> to Diagram' dialog and click on the OK button).

Notes

- To add an element to the currently-open diagram, click on the appropriate icon and drag it into position on the diagram; set an element name and other properties as prompted
- To add a relationship, click on the appropriate icon, then click on the start element in the diagram and drag to the end element

Class Toolbox

The Class Toolbox can be used for creating Class models and Data models. Such models contain Package diagrams, Class diagrams and Object diagrams - those diagrams that usually display elements concerned with the logical structure of the system, such as Objects, Classes and Interfaces.

Logical models can include domain models (high level business driven object models) through to strict development Class models (defining inheritance, attributes and operations).

Class Toolbox pages

Image	Detail
	<p>Except where discussed here, each element and relationship that you can create using these Toolbox pages is described in the <i>UML Elements</i> and <i>UML Connectors</i> sections of the Help.</p> <p>You use the Table element to insert a stereotyped Class for use in data modeling.</p> <p>The Association element is an n-ary Association, which is used to model complex relationships between three or</p>

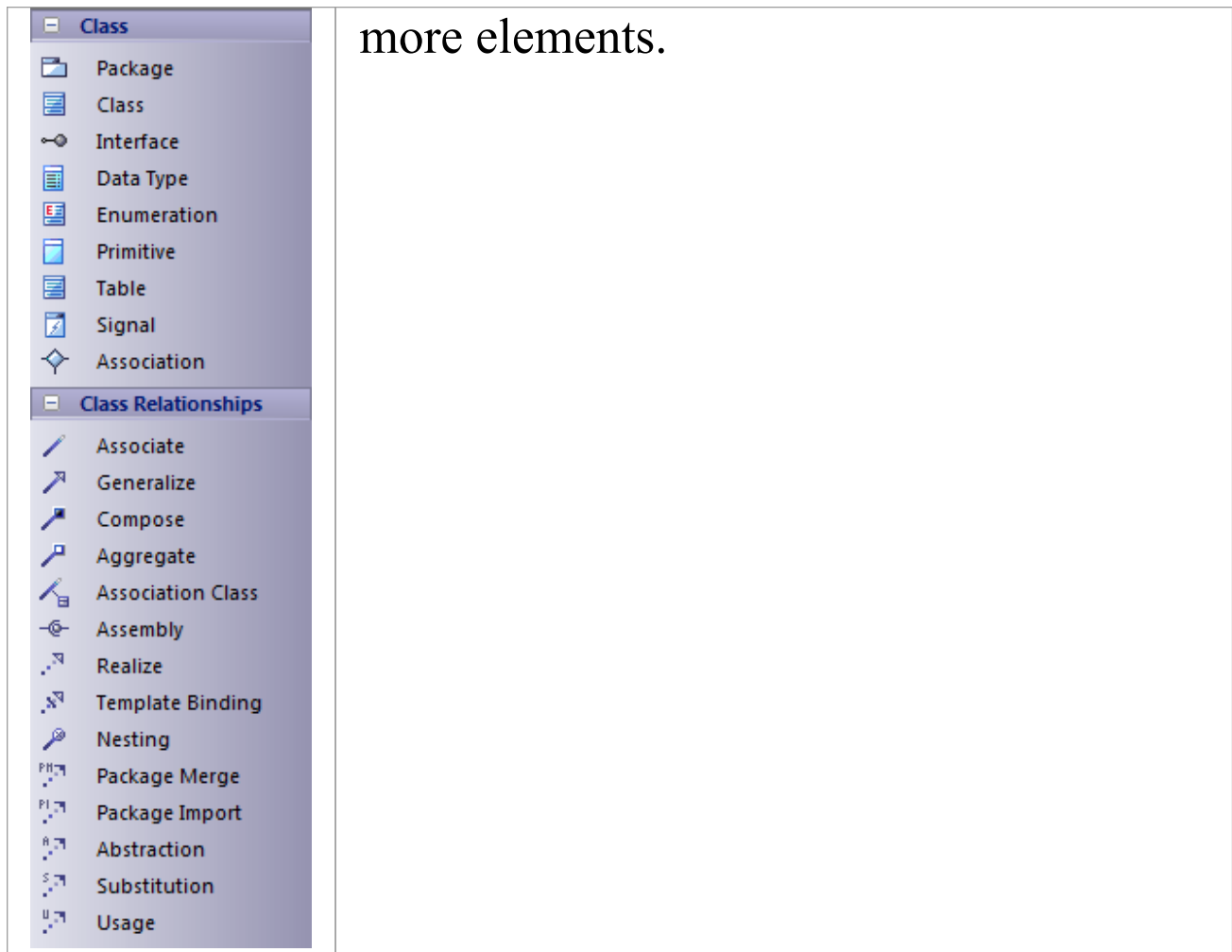

Notes

- To add an element to the currently-open diagram, click on the appropriate icon and drag it into position on the diagram; set an element name and other properties as prompted
- To add a relationship, click on the appropriate icon, then click on the start element in the diagram and drag to the end element

Object Toolbox

The Object Toolbox is used to create Object diagrams, which reflect multiplicity and the roles that instantiated Classes could serve. They are useful in creating different cases in which relationships and Classes are applied.

Object Toolbox pages

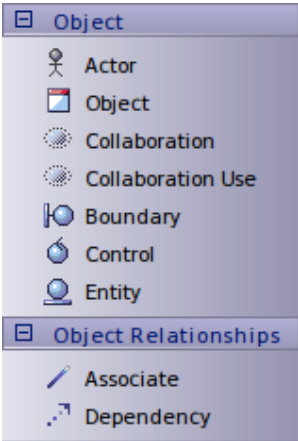
Image	Detail
	<p>Except where discussed here, each element and relationship that you can create using these Toolbox pages is described in the UML Elements and UML Connectors sections of the Help.</p> <p>A Boundary is a stereotyped Object that models some system boundary, typically a user interface screen.</p> <p>A Control is a stereotyped Object that models a controlling entity or manager.</p> <p>An Entity is a stereotyped Object that models a store or persistence mechanism that captures the information or knowledge in a system.</p>

Notes

- To add an element to the currently-open diagram, click on the appropriate icon and drag it into position on the diagram; set an element name and other properties as prompted
- To add a relationship, click on the appropriate icon, then click on the start element in the diagram and drag to the end element

Composite Toolbox

The Composite Toolbox is used to create Composite Structure diagrams. These reflect the internal collaboration of Classes, Interfaces or Components to describe a functionality or to express run-time architectures, usage patterns and the participating elements' relationships, which static diagrams might not show. The Class elements form the basic structure of the diagram, with Interface, Part, Port and Collaboration elements defining the functionality or use of the Classes.

Composite Toolbox pages

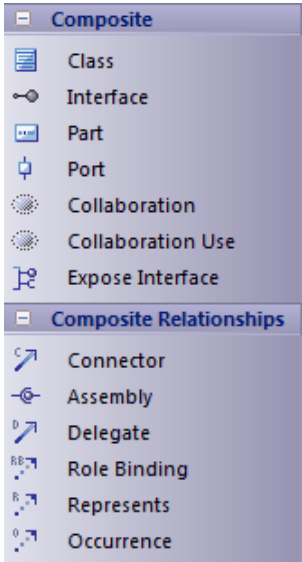
Image	Detail
	<p>Except where discussed here, each element and relationship that you can create using these Toolbox pages is described in the UML Elements and UML Connectors sections of the Help.</p>

Notes

- To add an element to the currently-open diagram, click on the appropriate icon and drag it into position on the diagram; set an element name and other properties as prompted
- To add a relationship, click on the appropriate icon, then click on the start element in the diagram and drag to the end element

Communication Toolbox

The Communication Toolbox is used to develop Communication diagrams, in which you model dynamic interactions between elements at run-time. These diagrams are used to model workflow and sequential passing of messages between elements in real time; they are often placed beneath Use Case elements to further expand on Use Case behavior over time.

The Actor element models a user of the system, while the other elements model things within the system, including standard elements (Object) and the user interface component (Boundary), Controller and Entity.

Communication Toolbox pages

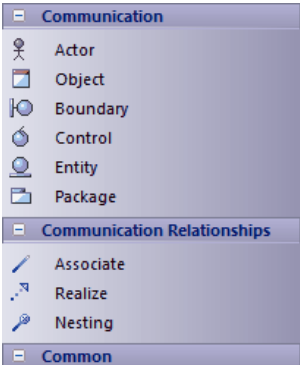
Image	Detail
	<p>Except where discussed here, each element and relationship that you can create using these Toolbox pages is described in the UML Elements and UML Connectors sections of the Help.</p> <p>A Boundary is a stereotyped Object that models some system boundary, typically a user interface screen.</p> <p>A Control is a stereotyped Object that models a controlling entity or manager.</p>

	<p>An Entity is a stereotyped Object that models a store or persistence mechanism that captures the information or knowledge in a system.</p>
--	---

Notes

- To add an element to the currently-open diagram, click on the appropriate icon and drag it into position on the diagram; set an element name and other properties as prompted
- To add a relationship, click on the appropriate icon, then click on the start element in the diagram and drag to the end element

Interaction Toolbox

The Interaction Toolbox is used to develop Sequence diagrams. You use Sequence diagrams to model dynamic interactions - workflow and the sequential passing of messages - between elements in real time. Sequence diagrams are often placed beneath Use Case elements to further expand on Use Case behavior over time.

Interaction Toolbox pages

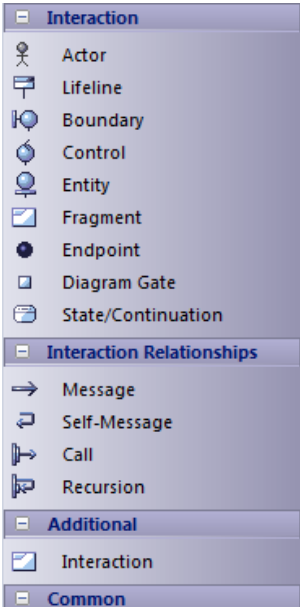
Image	Detail
	<p>Except where discussed here, each element and relationship that you can create using these Toolbox pages is described in the UML Elements and UML Connectors sections of the Help.</p> <p>A Boundary is a stereotyped Object that models some system boundary, typically a user interface screen.</p> <p>A Control is a stereotyped Object that models a controlling entity or manager.</p> <p>An Entity is a stereotyped Object that models a store or persistence mechanism that captures the information or knowledge in a system.</p>

Notes

- The Interaction element supports the capture of Interaction diagrams through the Browser window and diagram context menus; you cannot capture these diagrams by dragging the element onto a diagram
- The 'Fragment' icon creates Combined Fragment elements
- Message, Self Message and Call are described as Sequence diagram messages
- Messages can be simple or recursive calls
- To add an element to the currently-open diagram, click on the appropriate icon and drag it into position on the diagram; set an element name and other properties as prompted
- To add a relationship, click on the appropriate icon, then click on the start element in the diagram and drag to the end element

Timing Toolbox

The Timing Toolbox provides the modeling elements for creating Timing diagrams, which define the behavior of objects along a time-scale to visualize how the objects change state and interact over time.

Timing diagrams can be used for defining hardware-driven or embedded software components, and time-driven business processes.

Timing Toolbox pages

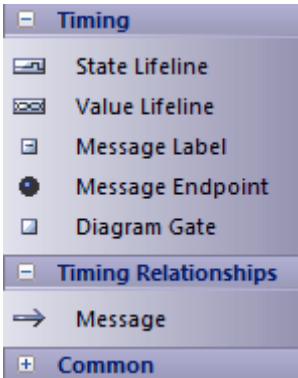
Image	Detail
	<p>Except where discussed here, each element and relationship that you can create using these Toolbox pages is described in the UML Elements and UML Connectors sections of the Help.</p> <p>The Message relationship is specifically described for Timing diagrams.</p>

Notes

- To add an element to the currently-open diagram, click on

the appropriate icon and drag it into position on the diagram; set an element name and other properties as prompted

- To add a relationship, click on the appropriate icon, then click on the start element in the diagram and drag to the end element

State Toolbox

The State Toolbox is used to develop StateMachine diagrams, to show the enableable states a Class or other element might be in and the transitions from one state to another. These diagrams are often placed under a Class element in the Browser window to illustrate how a particular element changes over time. States can have substates; for example, Accelerate and Brake might be substates of Active.

State Toolbox pages

Image	Detail
	<p>Except where discussed here, each element and relationship that you can create using these Toolbox pages is described in the <i>UML Elements</i> and <i>UML Connectors</i> sections of the Help.</p> <p>Event is used to create a basic Send element (the default) or Receive element on the StateMachine diagram.</p>



Notes

- To add an element to the currently-open diagram, click on the appropriate icon and drag it into position on the diagram; set an element name and other properties as prompted
- To add a relationship, click on the appropriate icon, then click on the start element in the diagram and drag to the end element

Activity Toolbox

The Activity Toolbox is used to model system dynamics from a number of viewpoints (represented by activities and the flows between them) in Activity diagrams and Interaction Overview diagrams. Both types of diagram are usually created under Activity elements.

Activities can be stereotyped as a process to display a business process icon; the Activity represents some work that is carried out, which might overlap several Use Cases or form only a part of one Use Case.

Activity Toolbox pages

Image	Detail
	<p>Except where discussed here, each element and relationship that you can create using these Toolbox pages is described in the <i>UML Elements</i> and <i>UML Connectors</i> sections of the Help.</p> <p>The 'Basic Activity' icon adds the Basic Activity Pattern to your diagram as a starting point for developing the diagram (drag the icon onto the diagram to open the 'Add Pattern <name> to Diagram' dialog and click on the OK button).</p>



Notes

- To add an element to the currently-open diagram, click on the appropriate icon and drag it into position on the diagram; set an element name and other properties as prompted
- To add a relationship, click on the appropriate icon, then click on the start element in the diagram and drag to the end element

Component Toolbox

The 'Component' pages of the Diagram Toolbox provide model elements that you can use to model the physical components of your system in a Component diagram. The 'Component' pages contain elements and connectors related to the actual building of the system - the components that make up the system (such as ActiveX DLLs or Java beans), the Interfaces they expose and the dependencies between those elements.

A component is a piece of hardware or software that makes up the system; for example, a DLL or a Web Server are components that might be deployed on a Windows 2000 Server (Node).

Component Toolbox pages

Image	Detail
	<p>Except where discussed here, each element and relationship that you can create using these Toolbox pages is described in the <i>UML Elements</i> and <i>UML Connectors</i> sections of the Help.</p> <p>A Packaging Component is an element that appears very similar to a Component in a diagram but behaves as a Package in the Browser window.</p>

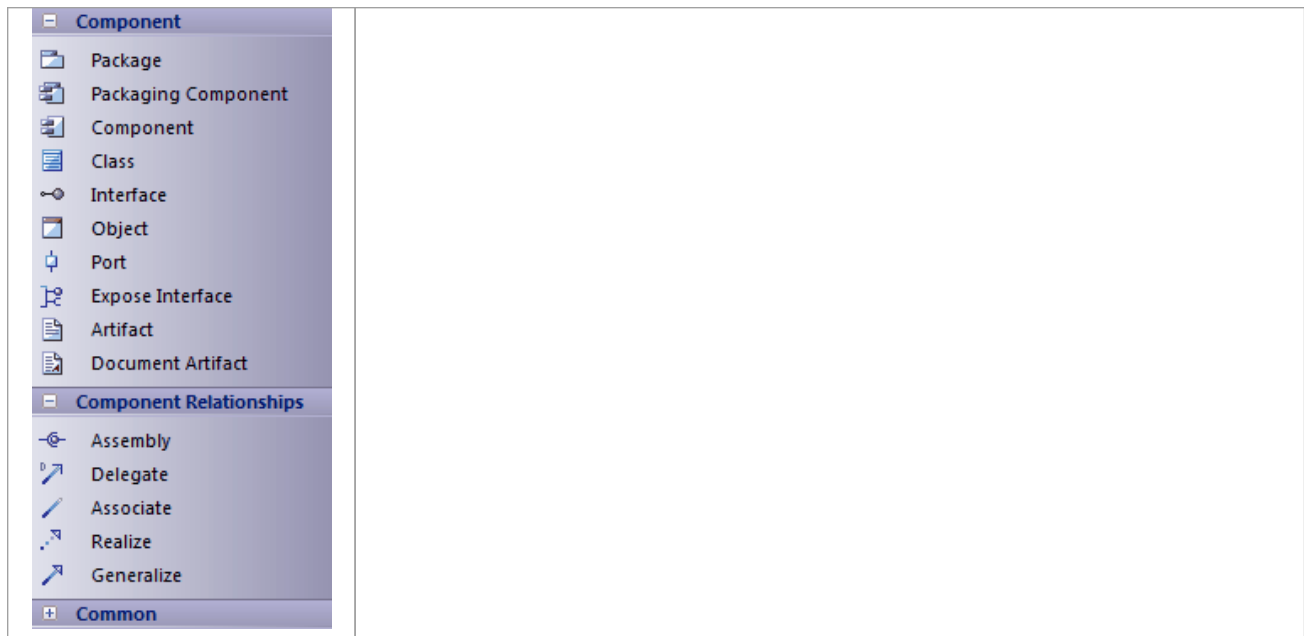

Notes

- To add an element to the currently-open diagram, click on the appropriate icon and drag it into position on the diagram; set an element name and other properties as prompted
- To add a relationship, click on the appropriate icon, then click on the start element in the diagram and drag to the end element

Deployment Toolbox

The Deployment Toolbox provides model elements that you can use to model the physical components and deployment structure of your system in a Deployment diagram. The Deployment group contains elements related to the actual building of the system - the hardware or software Components that make up the system (such as ActiveX DLLs or Web Servers) and the physical platforms (Nodes) those Components run on (such as a Windows 2000 Server), including the physical connections between Nodes.

Deployment Toolbox pages

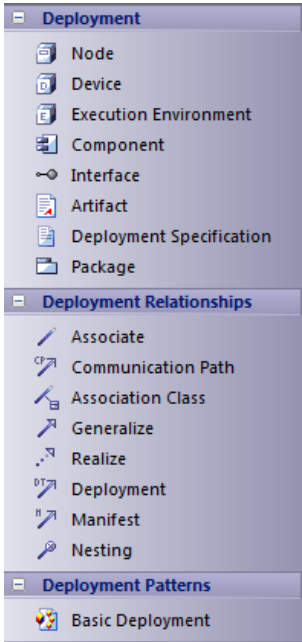
Image	Detail
	<p>Except where discussed here, each element and relationship that you can create using these Toolbox pages is described in the <i>UML Elements</i> and <i>UML Connectors</i> sections of the Help.</p> <p>The 'Basic Deployment' icon adds the Basic Deployment Pattern to your diagram as a starting point for developing the diagram (drag the icon onto the diagram to open the 'Add Pattern <name> to Diagram' dialog and click on the OK button).</p>

Notes

- To add an element to the currently-open diagram, click on the appropriate icon and drag it into position on the diagram; set an element name and other properties as prompted
- To add a relationship, click on the appropriate icon, then click on the start element in the diagram and drag to the end element

Profile Toolbox

The Profile Toolbox is used in creating Profiles, a generic mechanism for extending UML models. Profiles can define custom Stereotypes, Tagged Values, Diagram Types and Toolboxes.

The Toolbox also contains a set of Profile Helpers that provide templates and dialogs to help you create Stereotype Profiles, Toolbox Profiles and Diagram Profiles within an MDG Technology.

Profile Toolbox Pages

Image	Detail
	<p>The Profile Package element acts as the container for the diagrams, elements and connectors that define the Profile itself.</p> <p>The Stereotype element provides a mechanism for varying the behavior and type of a base UML model element.</p> <p>A Metaclass element represents the base UML element or connector type that you are extending.</p> <p>An Enumeration element is used to define an enumeration Tagged Value, which can be attached to one or more Stereotype elements that have been defined in the</p>

Profile.

A Data Type element is used to represent types of data, such as programming language primitive types, CORBA basic types, and Tagged Value types. For example, integer and string types are often treated as Data Types.

A Model Pattern element can be added to a <<profile>> package when creating a model-based MDG Technology using an <<mdg technology>> package. The element has two tagged values: 'pattern' references a package whose entire contents will be stored internally in the model, and 'rtf' references a document artifact whose linked document will likewise be stored internally in the model.

A Diagram Property attribute can be added to a Stereotype element to create a checkbox on an element's context menu, the value of which can be tested for in its shape script. The name of the Diagram Property will be used as the context menu label, and the alias of the Diagram Property will be the property tested for in the shape script. See the example in the Help topic *Query Methods*.

A Removed Attribute attribute is used when you want to prevent a Stereotype

element from inheriting an attribute from a generalized Stereotype element, when redefining a stereotype from another profile. Give the Removed Attribute the same name as the attribute to be removed. Profile Helpers are templates and dialogs that help you create, respectively:

- An MDG Technology Package to contain Profile definitions
- Stereotypes and Metaclasses within a UML Profile
- A customized Toolbox Profile
- Toolbox pages within the customized Toolbox
- A Diagram Profile to define an extended diagram type

An Extension relationship shows that a Stereotype extends a Metaclass; all Stereotypes must extend either:

- One or more Metaclasses, or
- Another Stereotype that extends a Metaclass; you can create a chain of extending Stereotypes that ultimately extend the Metaclass (however, in practice you are unlikely to have more than two Stereotypes in the chain)

A Generalize relationship shows that one Stereotype specializes a more general

Stereotype; the more general Stereotype must still extend a Metaclass.

A Tagged Value relationship defines a reference-type (that is, RefGUID) Tagged Value owned by the source Stereotype; the Tagged Value is named for the target role of this association, and is limited to referencing elements with the stereotype by the association target element

Notes

- To add an element to the currently-open diagram, click on the appropriate icon and drag it into position on the diagram; set an element name and other properties as prompted
- To add a relationship, click on the appropriate icon, then click on the start element in the diagram and drag to the end element

Metamodel Toolbox

The Metamodel Toolbox provides model elements for creating Metamodel diagrams.

Metamodel Toolbox pages

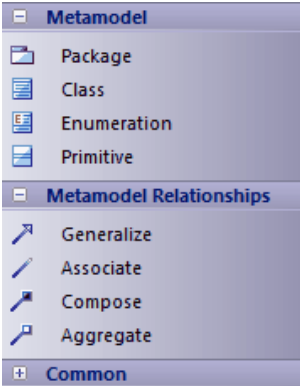
Image	Detail
	<p>Except where discussed here, each element and relationship that you can create using these Toolbox pages is described in the UML Elements and UML Connectors sections of the Help.</p> <p>The Metamodel Primitive element that supports the MOF specification, which you create using the Primitive icon, is deprecated. Use the Primitive element from the Class Toolbox.</p>

Notes

- To add an element to the currently-open diagram, click on the appropriate icon and drag it into position on the diagram; set an element name and other properties as prompted
- To add a relationship, click on the appropriate icon, then

click on the source element in the diagram and drag to the target element

Analysis Toolbox

Analysis-type elements are used early in modeling to capture business processes, activities, collaborations and general domain information. They are generally used in Analysis diagrams.

Analysis Toolbox pages

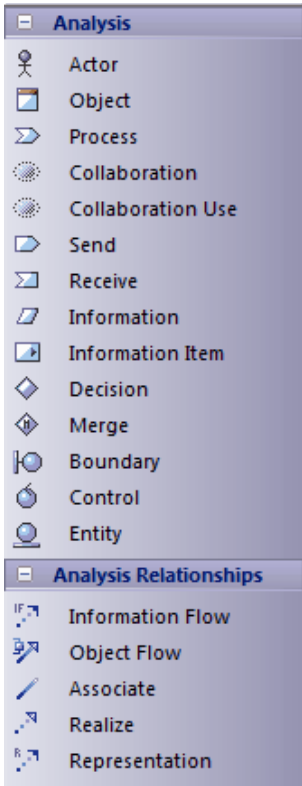
Image	Detail
 <p>The image shows a screenshot of the Analysis Toolbox in a modeling software. It is divided into two sections: 'Analysis' and 'Analysis Relationships'. The 'Analysis' section includes: Actor, Object, Process, Collaboration, Collaboration Use, Send, Receive, Information, Information Item, Decision, Merge, Boundary, Control, and Entity. The 'Analysis Relationships' section includes: Information Flow, Object Flow, Associate, Realize, and Representation.</p>	<p>Except where discussed here, each element and relationship that you can create using these Toolbox pages is described in the <i>UML Elements</i> and <i>UML Connectors</i> sections of the Help.</p> <p>A Process is a stereotyped Activity, used to model business processes.</p> <p>A Boundary is a stereotyped Object that models some system boundary, typically a user interface screen.</p> <p>A Control is a stereotyped Object that models a controlling entity or manager.</p> <p>An Entity is a stereotyped Object that models a store or persistence mechanism that captures the information or knowledge in a system.</p>

	<p>You can also use a number of stereotyped elements from the 'Business Modeling' pages of the Toolbox, to capture UML business process modeling extensions such as worker, case worker, entity and controller.</p>
--	---

Notes

- To add an element to the currently-open diagram, click on the appropriate icon and drag it into position on the diagram; set an element name and other properties as prompted
- To add a relationship, click on the appropriate icon, then click on the start element in the diagram and drag to the end element

Custom Toolbox

The Custom Toolbox contains extended UML elements that can be of use in modeling or designing your system in a Custom diagram.

Custom Toolbox pages

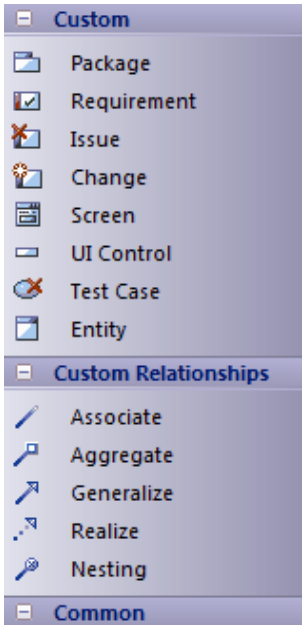
Image	Detail
 <p>The screenshot shows a vertical list of UML elements and relationships in a custom toolbox. The elements are grouped into three sections: 'Custom', 'Custom Relationships', and 'Common'. The 'Custom' section includes Package, Requirement, Issue, Change, Screen, UI Control, Test Case, and Entity. The 'Custom Relationships' section includes Associate, Aggregate, Generalize, Realize, and Nesting. The 'Common' section is partially visible at the bottom.</p>	<p>Except where discussed here, each element and relationship that you can create using these Toolbox pages is described in the UML Elements and UML Connectors sections of the Help.</p> <p>A Requirement is a custom element used to capture requirements external to standard UML elements; a Requirement expresses required system behavior that can cross several Use Cases.</p> <p>You can connect Requirements to other elements using the Realize connector to express the implementation of a requirement and hence the traceability from user requirements to what is being built.</p> <p>An Issue element is a structured comment</p>

that contains information about defects and issues relating to the system/model; affected elements are connected by Trace connectors.

A Change element is a structured comment that contains information about changes requested to the system/model; affected elements are connected by Trace connectors.

A Screen provides a stereotyped Class element that displays a GUI type screen; this can be used to express application GUI elements and flows between them.

A UI Control likewise can be used to express GUI controls.

A Test Case element defines what must be set up in order to test a particular feature; you can use it to define a set of tests once for a number of elements. As an element rather than a property, it provides greater visibility for tests.

Entity - use of this element is deprecated - it was originally intended to take the role now supplied by the Table element.

Notes

- To add an element to the currently-open diagram, click on the appropriate icon and drag it into position on the diagram; set an element name and other properties as prompted
- To add a relationship, click on the appropriate icon, then click on the start element in the diagram and drag to the end element

Requirements Toolbox

As an analysis step, often it is desirable to capture simple system requirements. These are eventually realized by Use Cases.

Requirements Toolbox pages

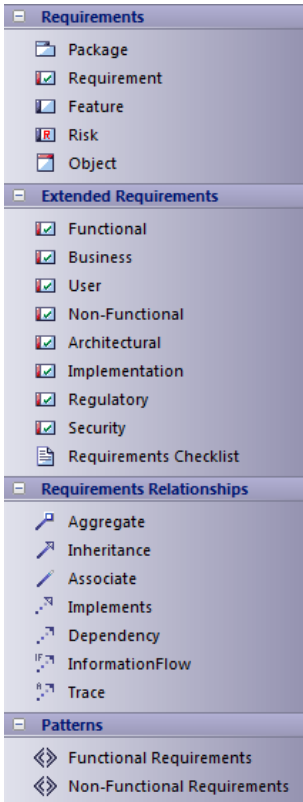
Image	Detail
	<p>Except where discussed here, each element and relationship that you can create using these Toolbox pages is described in the <i>UML Elements</i> and <i>UML Connectors</i> sections of the Help.</p> <p>A Requirement is a custom element used to capture system requirements external to individual UML elements; a Requirement expresses required system behavior that can cross several Use Cases. You can create a number of specific types of stereotyped Requirement from their own element icons.</p> <p>Requirements Checklist is a stereotyped Checklist, and is rendered as this element:</p>

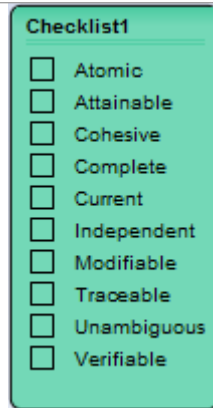

A Feature is a small client-valued function expressed as a requirement. Features are the primary requirements-gathering Artifact of the Feature-Driven Design (FDD) methodology.

A Risk element represents an identified risk to the project.

You can also add structures of Functional and Non-Functional Requirements to your diagram, each with a Checklist, using the two Requirements Patterns.

Notes

- To add an element to the currently-open diagram, click on the appropriate icon and drag it into position on the diagram; set an element name and other properties as prompted
- To add a relationship, click on the appropriate icon, then click on the start element in the diagram and drag to the

end element

Maintenance Toolbox

The Maintenance Toolbox provides the elements and connector for defining and monitoring Issues, Defects, Changes, work Tasks and Tests for project management.

Maintenance Toolbox pages

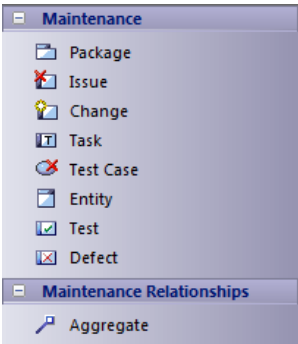
Image	Detail
	<p>Except where discussed here, each element and relationship that you can create using these Toolbox pages is described in the <i>UML Elements</i> and <i>UML Connectors</i> sections of the Help.</p> <p>An Issue element is a structured comment that contains information about issues relating to the system or model; affected elements are linked by Trace connectors.</p> <p>A Change element is a structured comment that contains information about changes requested to the system/model; affected elements are connected by Trace connectors.</p> <p>A Task element defines a task attached to an element; you can assign resources specifically to the task rather than just to the parent element, and monitor the tasks</p>

on diagram Gantt charts.

A Test Case element defines what must be set up in order to test a particular feature; you can use it to define a set of tests once for a number of elements. As an element rather than a property, it provides greater visibility for tests.

An Entity is an abstract type that is often used in analysis to record that something is of interest to the system, without necessarily defining how it will be represented in the system.

A Test element represents a step in any of the Basic, Alternate or Exception Paths of a Scenario, created within a Use Case or other element.

A Defect element is a structured comment that contains information about defects relating to the system or model; affected elements are linked by Trace connectors.

Notes

- To add an element to the currently-open diagram, click on the appropriate icon and drag it into position on the diagram; set an element name and other properties as

prompted

- To add a relationship, click on the appropriate icon, then click on the start element in the diagram and drag to the end element

User Interface Toolbox

The User Interface Toolbox provides a wide range of icons that you can use to create User Interface diagrams.

User Interface Toolbox pages

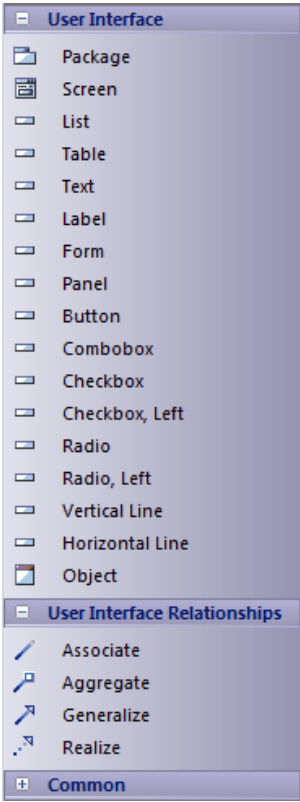
Image	Detail
 <p>The image shows a screenshot of the User Interface Toolbox. It is organized into several sections: <ul style="list-style-type: none"> User Interface: Contains icons for Package, Screen, List, Table, Text, Label, Form, Panel, Button, Combobox, Checkbox, Checkbox, Left, Radio, Radio, Left, Vertical Line, Horizontal Line, and Object. User Interface Relationships: Contains icons for Associate, Aggregate, Generalize, and Realize. Common: A separate section at the bottom. </p>	<p>Except where discussed here, each element and relationship that you can create using these Toolbox pages is described in the <i>UML Elements</i> and <i>UML Connectors</i> sections of the Help.</p> <p>The Screen element represents the screen or dialog frame in a graphical user interface. You can identify fields, delimiters and buttons on the screen using the different UI Control elements.</p> <p>UI Control elements are different stereotyped elements defining controls such as buttons, fields and combo boxes. You arrange these on the Screen element, as part of a User Interface diagram, to define a screen or dialog in a user interface.</p>
	<p>This diagram illustrates each type of UI</p>

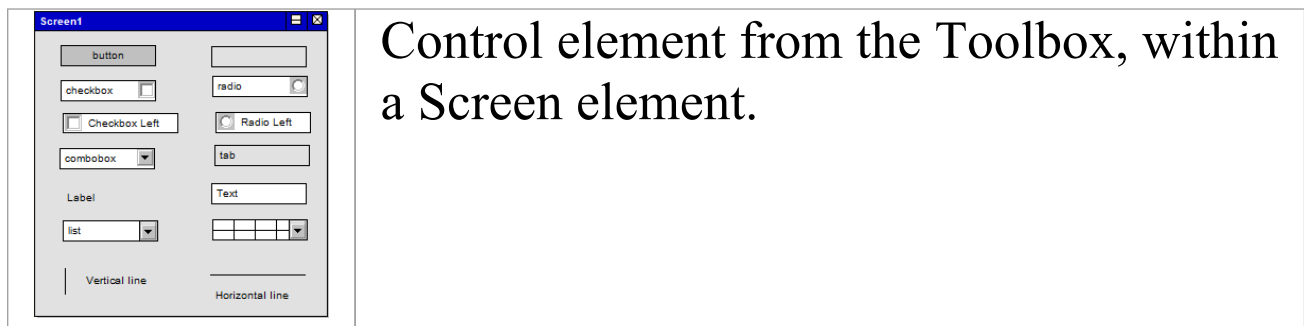

Control element from the Toolbox, within a Screen element.

Notes

- To add an element to the currently-open diagram, click on the appropriate icon and drag it into position on the diagram; set an element name and other properties as prompted
- To add a relationship, click on the appropriate icon, then click on the start element in the diagram and drag to the end element
- To place one UI Control object inside another (for example, adding fields or options to a Panel or Form), press Shift as you drag the object into place
- You can add objects to the diagram and move them around, but once the object is within the boundary of a Screen element (or another UI Control element) you cannot move it out of that boundary on the diagram; you can move child elements between parents on the Browser window
- If you delete a Screen (or other parent element) on the diagram, all the UI Control elements it contains are also deleted from the diagram

WSDL Toolbox

The WSDL Toolbox provides elements you can use to rapidly develop a W3C Web Service Definition Language (WSDL) model, from which you can automatically generate WSDL documents.

WSDL Toolbox page

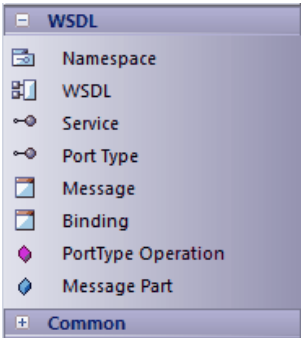
Image	Detail
	<p>A Namespace represents the top-level container for the WSDL model. Drag this element onto an open diagram to create the necessary model structure for WSDL documents.</p> <p>A physical WSDL document is represented as a UML Component. Its interfaces represent the WSDL Services.</p> <p>A WSDL Port Type is modeled as a UML Interface. Its Port Type Operations are realized by Binding elements.</p> <p>Each of the operation parameters is derived from the Message elements defined in the Messages Package.</p>

Notes

- To add an element to the currently-open diagram, click on the appropriate icon and drag it into position on the diagram; set an element name and other properties as prompted
- To add a relationship, click on the appropriate icon, then click on the start element in the diagram and drag to the end element

XML Schema Toolbox

The XML Schema Toolbox provides model elements that you can use to model W3C XSD schema files. This Toolbox implements the constructs provided by the UML Profile for XML Schema. Having created your model, you can automatically generate the W3C XSD schema files from it.

XML Schema Toolbox pages

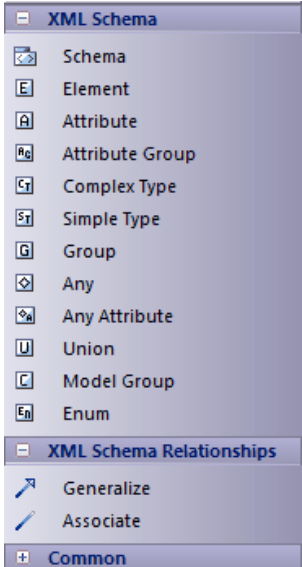
Image	Detail
 A screenshot of the XML Schema Toolbox. It shows a list of schema elements under the 'XML Schema' category, including Schema, Element, Attribute, Attribute Group, Complex Type, Simple Type, Group, Any, Any Attribute, Union, Model Group, and Enum. Below this, there is a section for 'XML Schema Relationships' with 'Generalize' and 'Associate' options, and a 'Common' section at the bottom.	<p>A Schema corresponds to a UML Package, which contains the type and element definitions for a particular targetNamespace. Drag this item onto an open diagram to create the Package to contain your schema model elements. The Package is stereotyped as XSDschema.</p> <p>Open the logical diagram created under the XSDschema Package and add additional schema elements to define the model.</p>

Notes

- To add an element to the currently-open diagram, click on the appropriate icon and drag it into position on the diagram; set an element name and other properties as prompted
- To add a relationship, click on the appropriate icon, then click on the start element in the diagram and drag to the end element

Data Modeling Toolbox

The Data Modeling Toolbox provides a basic set of elements for database modeling and database design, in conjunction with the UML Data Modeling Profile.

Data Modeling Toolbox page

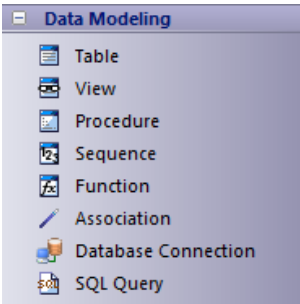
Image	Detail
	<p>In the data model, a:</p> <ul style="list-style-type: none">• Table defines a database table• View represents a database view• Procedure represents database (or Stored) procedures• Sequence represents a database Sequence• Function represents a database Function• Database Connection helps you to configure a connection to the database you are modeling, for testing, import and export of schema, and comparison of differences between database and model using the Database Builder When you drop this icon onto the diagram the system prompts you to indicate whether to create the

connection for an Access database, a Firebird database or an ODBC database
For the first two options, when you click on the OK button the system prompts you to select the file to create the connection to

If you select the 'ODBC database' option, the 'Select Data Source' dialog displays; click on the 'Machine Data Source' tab and select the data source (project on a database)

After you have defined the data source, when you double-click on the element the Database Builder view opens for the current database model

- SQL Query is an Artifact element that provides a convenient mechanism for storing an SQL Statement in the repository, for repeated execution on live database(s)

Notes

- To add an element to the currently-open diagram, click on the appropriate icon and drag it into position on the diagram; set an element name and other properties as prompted
- To add a relationship, click on the appropriate icon, then

click on the start element in the diagram and drag to the end element

Test Domain Toolbox

The Test Domain Toolbox provides a basic set of elements that you can use to create Test Domain diagrams, used in the Testpoint facility. A Test Domain diagram provides specific elements that can aid in the logical composition of tests into Test Sets and Test Suites.

Test Domain Toolbox page

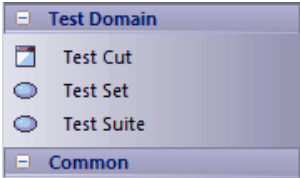
Image	Detail
	<p>A Test Cut is a group of operations that represent a specific behavior (such as Print) defined for a Class, separate from other constraints defined for the Class.</p> <p>A Test Set aggregates one or more groups of methods (Test Cuts) that perhaps span multiple Classes, into a single task.</p> <p>A Test Suite aggregates one or more groups of tasks (Test Sets).</p>

Notes

- To add an element to the currently-open diagram, click on the appropriate icon and drag it into position on the diagram; set an element name and other properties as

prompted

- To add a relationship, click on the appropriate icon, then click on the start element in the diagram and drag to the end element

XML Transformation Toolbox

The XML Transformation Toolbox page provides elements for modeling and executing the transformation of an input document into XML or other document formats under the control of an XSL Stylesheet. You can model and execute the transformation on an XML Transform diagram.

XML Transformation Toolbox page

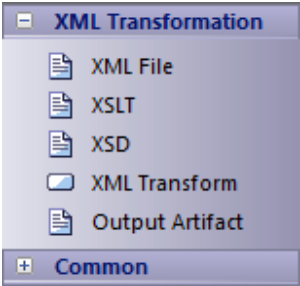
Image	Detail
	<p>XML File generates a File Artifact element, through which you identify the location of the input file to be transformed.</p> <p>XSLT generates a File Artifact element, through which you identify the XSLT Stylesheet to apply to the transformation.</p> <p>XSD generates a File Artifact that identifies the schema against which the output of the transformation (as directed in the Output Artifact element) is validated. The results of the validation are written to the 'XSL' tab of the System Output window.</p> <p>XML Transform generates a stereotyped Activity that performs the transformation.</p>

	<p>Output Artifact generates a File Artifact element, through which you specify the location of the output file generated by the transformation, on the 'Files' property page of the element. Output from the transformation will be written to this file. The elements can be connected to each other using Trace connectors.</p>
--	--

Notes

- To add an element to the currently-open diagram, click on the appropriate icon and drag it into position on the diagram; set an element name and other properties as prompted
- To add a relationship, click on the appropriate icon, then click on the start element in the diagram and drag to the end element

Diagram Properties

You can set several properties of a diagram using either the:

- 'Properties' dialog or the
- Properties window

This topic discusses the 'Properties' dialog. For information of the Properties window, see the Help topic *Properties Window for Diagrams*.

There are several options for opening the 'Properties' dialog for a given diagram:

- Double-click in the background of the open diagram
- Right-click on the background of the open diagram and select the 'Properties' option
- Select the 'Design > Diagram > Manage > Properties' ribbon option to open the 'Properties' dialog for the currently open diagram

In the 'Properties' dialog you can set properties including name, author and version information, zoom factor, paper size and layout, diagram notes and various appearance attributes. Some properties influence the display of the diagram and some are logical attributes that appear in the documentation.

Notes

- In the Corporate, Unified and Ultimate Editions of Enterprise Architect, if security is enabled you must have 'Update Diagrams' permission to change diagram

properties

- Using the 'Diagram - Gradients and Background' page of the 'Preferences' dialog, you can define the default diagram background color and color gradients for all your diagrams; these settings are also applied to any Diagram Theme you apply across your model

Diagram Properties - General

You use the 'General' tab of the diagram 'Properties' dialog to record facts concerning the diagram as an object, such as its title, version and modification date.

Access

Ribbon	Design > Diagram > Manage > Properties > General
Context Menu	Right-click diagram in Browser window Properties General Right-click background of open diagram Properties General
Other	On the Properties window for a diagram, click on the  icon

Set Diagram Properties

Option	Action
Name	Defaults to the name of the parent Package, as the name of the diagram.

	<p>If necessary, overwrite the field with a different diagram name. You can change the diagram name in this field whenever necessary.</p>
Author	<p>Defaults to the name of the person who created the diagram.</p> <p>If necessary, overwrite the field with a different author name, or click on the drop-down arrow and select a name from the list. You might do this if the diagram becomes the responsibility of another person.</p>
View	<p>Shows the specialization or viewpoint of the diagram within its type, initially set when you create the diagram through the 'New Diagram' dialog. For example, each of the UML Behavioral diagrams can be a Simple (Default) diagram or a more complex Behavioral (Complete) diagram; each UML Structural diagram could be a Simple diagram or a more complex Structural (Complete) diagram, whilst a Class diagram can additionally be a Domain Modeling, Hierarchy or Metamodel diagram. The View determines what elements and connectors are provided through the Diagram</p>

	<p>Toolbox, the Simple diagram types having the most basic set of toolbox items.</p> <p>You can change the View within the diagram type; click on the drop-down arrow and select the preferred View.</p>
Version	<p>Displays the version number (or other version reference) that has been manually set for the diagram. If this is a cloned diagram, the version number will have been defined as part of the cloning process. If no number has been set, the field defaults to 1.0.</p> <p>To update the version number, overtype the field.</p>
Filter to Version	<p>Select this checkbox to filter the elements on the diagram and mute those that do not have the same version number as the diagram. This is of particular value when you are working on the elements of a cloned diagram and want to distinguish between elements that have been cloned to match the diagram and Package structure, and elements that are still the same version as the source.</p> <p>You can use the facility to check more generally which elements are not of the</p>

	<p>same version as the diagram, such as when you drag elements from the Browser window as links to local or, more especially, external elements.</p> <p>The filter takes effect when you click on the OK button.</p>
Set new elements to Version	<p>Select this checkbox to set the version of every new element added to the diagram to the same version as the diagram. Elements dragged and dropped from the Diagram Toolbox or added using the 'New Element' dialog will have the same version as the diagram. The version value of elements dragged and dropped from the Browser window will not be updated.</p>
Stereotype	<p>(Optional) Type in the name of a diagram stereotype to apply, or click on the drop-down arrow and select a stereotype from the list.</p> <p>You can define stereotypes to select here using the 'Settings > Reference Data > UML Types' ribbon option, selecting the 'Stereotypes' page and creating stereotypes with a 'Base Class' of 'Diagram'.</p>
Created	Automatically displays the date on which

	<p>the diagram was created.</p> <p>If necessary, overwrite the field with an amended creation data, or click on the drop-down arrow and select the date.</p>
Modified	Automatically displays the date and time when the diagram was last modified.
GUID	Read-only field, displaying the GUID of the selected diagram.
Notes	Type in any additional information on the diagram. You can format the notes using the Notes toolbar at the top of the field.
OK	If you have finished updating the diagram properties, click on this button to save the changes and close the 'Properties' dialog.
Cancel	If you do not want to save the changes you have made, click on this button to discard the changes and close the dialog.
Help	Click on this button to display this Help topic.

Notes

- In the Corporate, Unified and Ultimate Editions of Enterprise Architect, if security is enabled you must have 'Update Diagrams' permission to update diagram properties

Diagram Properties - Detail

A diagram can show or hide information, and represent it in different ways depending on how you configure the display characteristics. You can maintain your display configuration using the diagram 'Properties' dialog ('Diagram' tab).

Access

Ribbon	Design > Diagram > Manage > Properties > Diagram
Context Menu	Right-click diagram in Browser window Properties Diagram Right-click background of open diagram Properties Diagram

Set the diagram display options

Option	Action
Use Alias if Available	Select this checkbox to display the element alias as the element's name, wherever the alias is specified.

<p>Show Additional Parents</p>	<p>Select this checkbox to display the names of all parent elements not in the current diagram, for all Classes and Interfaces.</p>
<p>Hide Page Border (All Diagrams)</p>	<p>Select this checkbox to disable the display of page borders on all diagrams in the model.</p>
<p>Hide Page Border (Current Diagram)</p>	<p>Select this checkbox to disable the display of the page border on the current diagram only. (Disabled if 'Hide Page Border (All Diagrams)' is selected.)</p>
<p>Show Diagram Details</p>	<p>Select this checkbox to show diagram details in a note in the top left corner of the diagram.</p> <div data-bbox="518 1205 780 1312" style="border: 1px solid #ccc; padding: 5px; margin: 10px 0;"> <p>Name: Location Package: External factors Version: 1.0 Author: rchester</p> </div> <p>Deselect the option to hide the diagram details.</p>
<p>Show Sequence Notes</p>	<p>(On a Sequence diagram) Select this checkbox to display the internal Notes for each Message down the left-hand edge of the diagram. Each note has the same number as the Message it comes from.</p> <div data-bbox="518 1832 1310 1910" style="border: 1px solid #ccc; padding: 5px; margin: 10px 0;">  </div>
<p>Disable fully</p>	<p>Select this checkbox to disable the use of</p>

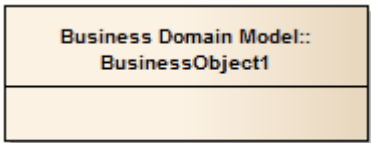
<p>scoped object names</p>	<p>fully scoped object names for elements in this diagram. This automatically deselects the 'Show Namespace' option and hides the 'Namespace::element Name' in each element, but does not hide the '(from 'Namespace')' label.</p> <p>The effect of this option is disabled if 'Fully Qualified Namespace' is also selected.</p>
<p>Display Element Lock Status</p>	<p>Select this checkbox to add a locking indicator (🔒 or 🔓) outside the top left corner of each locked element on the diagram.</p> <p>If the element is:</p> <ul style="list-style-type: none"> • Fully locked or locked by another user, the indicator is red • Locked by you or by another user in the same user group as you, the indicator is blue • Not locked, no indicator displays
<p>Show Namespace</p>	<p>Select this checkbox to show the namespace of each element on the diagram.</p> 

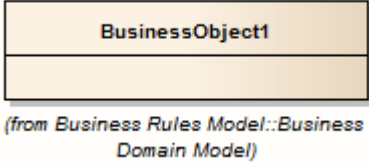
	<p>For Class, Interface, Enumeration, Component, Node and Artifact elements, the namespace is shown as part of the element name; that is, 'Namespace::element Name'. For elements of other types, the namespace is shown as a '(from 'Namespace')' label beneath the element.</p>
<p>Fully Qualified Namespace</p>	<p>(Enabled when 'Show Namespace' is selected) Select this checkbox to show the fully qualified namespace of each element on the diagram, as a '(from 'Namespace')' label under the element.</p> 
<p>Always Open as Element List</p>	<p>Select this checkbox to always display the diagram contents as a Diagram List rather than as a diagram.</p>
<p>Always Open as Gantt</p>	<p>Select this checkbox to always display the diagram contents as a Gantt chart.</p>
<p>Always Open as Specification</p>	<p>Select this checkbox to always display the diagram contents as a list of text descriptions in the Specification Manager.</p>

Page Setup	Adjust the scaling of the diagram image according to the size of the page it is to be printed on.
Print Page Header and Page Footer	Select this checkbox to add page headers and footers to a print-out of the diagram. The headers and footers are generated from the diagram characteristics, such as the name of the creator and the date of modification.
Background Tile	<p>Click on the  button and select a background tile design to apply just to this diagram. The filename of the background design file displays in the left-hand field.</p> <p>If you no longer want to apply a background tile to the diagram, click on the Clear button.</p>
Document Generation Options	These are options for generating document reports that include the selected diagram.
Exclude image from Documentation	Select this checkbox to exclude this diagram image from any document report generated on the parent Package or element.

<p>Add each contained element in Documentation</p>	<p>Select this checkbox to include documentation on each element in this diagram, in any document report generated on the parent Package or element.</p>
<p>Divide Diagram into Multiple Pages</p>	<p>Select this checkbox to divide each large diagram into separate pages in the document report.</p>
<p>Rotate Images</p>	<p>Select this checkbox to rotate each diagram image by 90 degrees in the document report.</p>
<p>Default Zoom</p>	<p>This facility is enabled when the selected diagram in the 'Properties' dialog is open and available for editing in the Diagram View (that is, open and not locked).</p> <p>Zoom in or out of the diagram to achieve the required magnification using either Ctrl+mouse wheel before you open the 'Properties' dialog, or the slider control on this 'Diagram' page. Click on the Set as Default button. Now, each time the diagram is opened, it will default to this zoom level.</p> <p>This diagram-local default zoom</p>

	<p>overrides any global zoom setting you have imposed for your user ID, using the slider in the Status bar.</p>
<p>Make all elements dockable</p>	<p>Select this checkbox to set all elements on the diagram as dockable.</p> <p>Setting elements as dockable allows you to align and join the elements either vertically or horizontally, on the current diagram only.</p> <p>Elements that you dock must have the joining edges parallel. As the distance between the elements narrows, the moving element snaps to the edge of the stationary element. Deselecting the 'Dockable' option does not separate the elements; if necessary, you can simply move the elements apart again.</p> <p>Activity Partitions already have the option selected by default.</p>
<p>Set Layout Style</p>	<p>Click on this button to define the layout of the diagram, to be applied automatically when you select the 'Layout Diagram' options.</p>
<p>OK</p>	<p>If you have finished updating the diagram properties, click on this button to save the changes and close the 'Properties' dialog.</p>

Cancel	If you do not want to save the changes you have made, click on this button to discard the changes and close the dialog.
Help	Click on this button to display this Help topic.

Notes

- The 'Divide Diagrams into Multiple Pages' option is only effective when the 'Scaled Printing' option on the 'Print Advanced' dialog is set to 'None'
- 'Rotate Images' is only available for bitmap (.bmp) images

Diagram Properties - Elements

It is possible to show a number of element characteristics on a selected diagram. You can define which of these characteristics to show, by selecting the corresponding checkboxes on the 'Elements' tab of the diagram 'Properties' dialog (and, conversely, which to hide by clearing their checkboxes). You can also override the model default coding language and set a different language for the elements in the context of this diagram.

Access

Ribbon	Design > Diagram > Manage > Properties > Elements
Context Menu	Right-click background of open diagram Properties Elements

Set Component Display Options

Option	Action
Use Stereotype	For elements that have whole shapes drawn by Enterprise Architect (such as

Icons	<p>Analysis stereotypes), select this checkbox to draw the alternative shape (if defined).</p> <p>For elements that have an icon displayed in the top right corner (such as an Artifact element), if 'Show Element Stereotypes' is selected, select this checkbox to display the stereotype icon instead of the stereotype text.</p>
Show Element Stereotypes	<p>For elements that have whole shapes drawn by Enterprise Architect, if 'Use Stereotype Icons' is deselected, select this checkbox to display any stereotype and keyword on the element.</p> <p>For elements that have an icon displayed in the top right corner, select this checkbox to indicate that a stereotype is present (icon if 'Use Stereotype Icons' is selected, text if not).</p>
Show Port Classifiers	<p>Select this checkbox to show the classifier of each Port on the diagram.</p>
Show Property Type	<p>Select the checkbox to show Port and Part types on the diagram by default.</p>
Show Data	<p>Select this checkbox to display the owner</p>

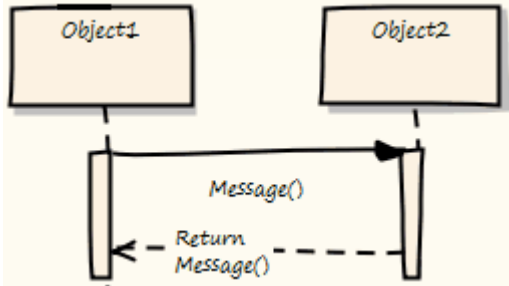
<p>Model Owner</p>	<p>of each Table element in the diagram. This is defined in the Owner Tagged Value on the table or, for PostgreSQL, Owner To.</p>
<p>Show Element Property String</p>	<p>Select this checkbox to show the advanced property string for all elements; for example, {leaf}.</p>
<p>Group Tags by Stereotype</p>	<p>Select this checkbox to organize the Tagged Values shown on the element on the diagram into groups according to stereotype.</p>
<p>Hand Drawn</p>	<p>Select this checkbox to display the diagram contents as if they had been roughly drawn by hand.</p>  <p>The diagram shows two rectangular boxes labeled 'Object1' and 'Object2'. A solid line with an arrowhead points from Object1 to Object2, labeled 'Message()'. A dashed line with an arrowhead points from Object2 back to Object1, labeled 'Return Message()'.</p>
<p>Whiteboard Mode</p>	<p>Select this checkbox to display the diagram as if it had been drawn on a whiteboard, with white fill and background.</p>

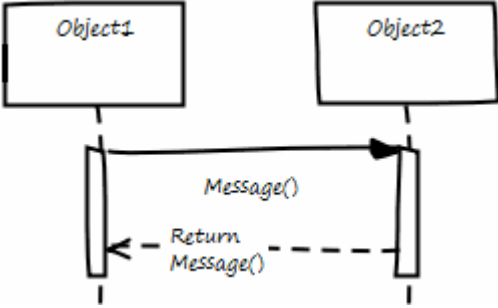
	 <p>(This illustration also has 'Hand Drawn' mode enabled.)</p>
<p>Custom Draw</p>	<p>Select this checkbox to turn on diagram custom style. Clear the checkbox to revert to normal notation. Changes to this checkbox are reflected in the 'Custom Style' checkbox in the diagram Properties window, and vice versa.</p>
<p>Show Shape Scripts</p>	<p>Defaults to selected to show elements and connectors with their Shape Scripts, on the diagram. Clear the checkbox to show elements and connectors in their native shapes.</p> <p>This option does not affect Custom Compartments. To hide those, deselect the appropriate checkboxes in the 'Show Compartments' panel, or on the element 'Compartment Visibility' dialog.</p>
<p>Show Compartments</p>	<p>Select each checkbox to show the corresponding feature or property compartment for all elements using</p>

Rectangle Notation on the diagram:

- Attributes
- Inherited attributes
- Operations
- Inherited operations
- Requirements
- Inherited requirements
- Testing (Testing Scripts)
- Discussions
- Resources (including 100% complete resources allocated to the element)
- Notes
- Tags (Tagged Values)
- Inherited tags
- Fully Qualified tags
- Receptions
- Constraints
- Inherited constraints
- Maintenance (Maintenance Scripts)
- Reviews
- Project
- Package contents

Deselect the checkbox for each compartment you want to hide.

If you have added custom compartments to your model display, such as Related

	<p>Elements, Flow Ports or Parts, 'Show Compartments' checkboxes are also listed for each of them. These checkboxes default to selected to show the compartments on the diagram; deselect the checkboxes to hide the compartments. If the checkboxes do not seem to operate for an element on a diagram, also check the 'Compartment Visibility' settings for that element.</p>
Language	<p>Click on the drop-down arrow and select the programming language that elements created on this diagram receive, overriding the model default language. If you do not want to override the model default, select the value <none> from the drop-down list.</p>
Support Collaboration	<p>Select a value to flag elements on this diagram where monitoring for new messages has been turned on for:</p> <ul style="list-style-type: none">• Elements that are the subject of Discussions• Chat messages to specific user groups (Chat messages to individual users are automatically monitored) <p>If an element is the subject of a monitored Discussion, and an unread</p>

message is in the 'Discuss' tab of the Discuss & Review window, the  icon displays against the element on the diagram.

Each monitored Chat group or user should be represented by an Actor element on the diagram. If a user or a member of a group sends a Chat message, the  icon displays against the appropriate Actor element on the diagram.

There are four options:

- None - to turn Collaboration support off so that no notification icons display (any other option turns Collaboration support on for Discussions)
- With Alias - for Chat messages, to check the Actor elements to locate the one that has the poster's user ID or group ID in the 'Alias' field
- With Locking User - for Chat messages, to check the Actor elements for the one that has been locked under the poster's user ID or group ID
- With Both - for Chat messages, to check firstly for the user ID that locked the element and, if that is not found, for the 'Alias' field containing the poster's user ID

OK	If you have finished updating the diagram properties, click on this button to save the changes and close the 'Properties' dialog.
Cancel	If you do not want to save the changes you have made, click on this button to discard the changes and close the dialog.
Help	Click on this button to display this Help topic.

Diagram Properties - Features

The features - attributes and operations - of an element have a number of properties that you can show or hide on a diagram, or use to show or hide the features themselves. You control how the features are displayed using the 'Features' tab of the diagram 'Properties' dialog.

Access

Ribbon	Design > Diagram > Manage > Properties > Features
Context Menu	Right-click diagram in Browser window Properties > Features Right-click background of open diagram Properties > Features

Define the display of features on the diagram

Option	Action
Show Qualifiers	Select this checkbox to show the qualifiers and visibility indicators of each

and Visibility Indicators	<p>feature on the diagram.</p> <p>Qualifiers include such things as the 'derived' symbol (/) and the public key symbol (PK).</p> <p>Visibility indicators include such things as +, -, # and ~, which indicate the scope of access of the item (such as an attribute, operation or role).</p>
Show Stereotypes	<p>Select this checkbox to show the stereotypes of all features that have them.</p> <p>Deselect the checkbox to hide the stereotypes.</p>
Show Operation Return Type	<p>Select this checkbox to display the return data type of each operation.</p>
Show Property String	<p>Select this checkbox to show the advanced property string for all element features, for example, {readOnly}.</p>
Suppress Brackets for Operations Without Parameters	<p>Select this checkbox to suppress brackets on operations that have no parameters; that is, Opn; rather than Opn();.</p>
Always	<p>Select this checkbox to force display of</p>

Show Linked Features	linked attributes and operations, regardless of the setting of any other option that might hide them.
Visible Class Members	Select the appropriate checkboxes to show Class members according to their scope and methods that specify properties.
Show Attribute Detail	Click on the drop-down arrow and select whether to show both the attribute name and type, or the attribute name only.
Show Parameter Detail	<p>Click on the drop-down arrow and select how to display method parameters:</p> <ul style="list-style-type: none"> • None - No details shown • Type Only - Show the type of parameter only • Full Details - Show all details of each parameter • Name Only - Show the name of the parameter only
Supress Compartment Items	These three edit control fields each suppress the display of the feature names listed in the field, in the corresponding feature-type compartment of an element depicted on the diagram.

	<ul style="list-style-type: none">• In the 'Attributes' field, list the attributes to suppress in the Attributes compartment of the element• In the 'Operations' field, list the operations to suppress in the Operations compartment of the element• In the 'Tag Names' field, list the tags to suppress in the Tagged Values compartment of the element <p>You can type the feature names separated by commas or by carriage returns.</p>
OK	If you have finished updating the diagram properties, click on this button to save the changes and close the 'Properties' dialog.
Cancel	If you do not want to save the changes you have made, click on this button to discard the changes and close the dialog.
Help	Click on this button to display this Help topic.

Diagram Properties - Connectors

It is possible to control a number of aspects of how connectors are shown on a diagram, using the 'Connectors' tab of the diagram 'Properties' dialog.

Access

Ribbon	Design > Diagram > Manage > Properties > Connectors
Context Menu	Right-click diagram in Browser window Properties Connectors Right-click background of open diagram Properties Connectors

Define Connector Appearance

Option	Action
Show Relationships	Select this checkbox to show connectors between elements in the current diagram. Deselect the checkbox to hide all connectors on the diagram.

Freeze Visible	Click on the checkbox to select it, to freeze the diagram to show only the connectors that are visible on this diagram at this point. Connectors that are subsequently created on other diagrams between the same elements are not added to this diagram until the option is deselected and the diagram is refreshed.
Show Collaboration Numbers	(In Communication diagrams) Select the checkbox to show the group numbering on Communication Messages. Messages are added to Association connectors in the Communication diagram.
Show Non-Navigable Ends	Select this checkbox to indicate when Association ends are not navigable; a cross is shown on each non-navigable end of an Association connector.
Show Connector Property String	Select this checkbox to show the property strings (constraint text) for connectors.
Suppress All Connector Labels	Select this checkbox to hide all connector labels on the diagram.

Show Stereotype Labels	<p>Select this checkbox to show a label on each connector indicating the connectors' stereotype.</p> <p>Deselect the checkbox to hide these stereotype labels.</p>
Connector Notation	<p>Click on the drop-down arrow and select the required connector notation:</p> <ul style="list-style-type: none">• UML 2.1 - use the standard UML 2.1 notation for connectors• Information Engineering - use the Information Engineering (IE) connection style• IDEFX1 - use the Integrated Definition Methods IDEFX1 connection style <p>Note that Information Engineering style does not work on Associations that are defined with Shape Scripts, so take care in using it. The option is blocked for use on ArchiMate diagrams for this reason.</p>
OK	<p>If you have finished updating the diagram properties, click on this button to save the changes and close the 'Properties' dialog.</p>
Cancel	<p>If you do not want to save the changes you have made, click on this button to</p>

	discard the changes and close the dialog.
Help	Click on this button to display this Help topic.

Diagram Properties - Theme

A Theme is a definition of the display characteristics for a diagram, such as the text font used or the background colors of the elements and diagram. You generally create and/or select a theme to apply to all diagrams across the model, but you can apply a different (existing) theme to a selected diagram, using the 'Theme' page of the diagram's 'Properties' dialog.

Themes applied to diagrams are model-based rather than user-based. If the diagram is imported into a model without an applied theme, the global theme will be used instead.

Access

Ribbon	Design > Diagram > Manage > Properties > Theme
Context Menu	Right-click diagram in Browser window Properties Theme Right-click background of open diagram Properties Theme

Select Theme

Option	Description
Theme	<p>Click on the drop-down arrow and select the theme to apply to the current diagram. The field defaults to the value 'Use global theme', which applies the theme selected on the 'Diagram > Themes' page of the model 'Preferences' dialog.</p>
Font	<p>Select the checkbox to apply the 'User Font Face' and 'Font Size' settings assigned to the selected theme on the 'Appearance' page of the model 'Preferences' dialog.</p> <p>Deselect the checkbox to apply the font from the global theme on the 'Preferences' dialog.</p>
Color	<p>Select the checkbox to apply the element, connector and diagram colors assigned to the selected theme on the 'Gradients and Background' page and the 'Standard Colors' page of the model 'Preferences' dialog.</p> <p>Deselect the checkbox to apply the colors from the global theme on the 'Preferences' dialog.</p>
Line	<p>Select the checkbox to apply the default</p>

Thickness	<p>element border width and connector line thickness assigned to the selected theme on the 'Appearance' page and 'Link' page of the model 'Preferences' dialog.</p> <p>Deselect the checkbox to apply the line widths from the global theme on the 'Preferences' dialog.</p>
Gradient	<p>Select the checkbox to apply the gradient of the diagram background color and element fill color, as assigned to the selected theme on the 'Gradients and Background' page of the model 'Preferences' dialog.</p> <p>Deselect the checkbox to apply the gradients from the global theme on the 'Preferences' dialog.</p>
Background Image	<p>Select the checkbox to apply the diagram background image assigned to the selected theme on the model 'Preferences' dialog.</p> <p>Deselect the checkbox to apply the image from the global theme on the 'Preferences' dialog.</p>
Element Shadows	<p>Select the checkbox to apply the element shadow setting ('on' or 'off') and color assigned to the selected theme on the</p>

	<p>model 'Preferences' dialog.</p> <p>Deselect the checkbox to apply the shadow setting and color from the global theme on the 'Preferences' dialog.</p>
OK	<p>Click on this button to apply the theme aspects you have defined on this tab, and to close the 'Properties' dialog.</p>
Cancel	<p>Click on this button to abort the changes you have made and close the 'Properties' dialog.</p>
Help	<p>Click on this button to display this Help topic.</p>

The Quick Linker

If you want to create new elements and connectors quickly on a diagram, you can use the Quick Linker on an initial element to guide you in creating related elements and connectors of the appropriate types, without having to weigh up the full range of options from the Diagram Toolbox.

The Quick Linker consists of paired menus that list the commonest objects appropriate to the context of the selected element. You simply choose the type of element you need from the first menu, and that displays the second menu offering a choice of appropriate types of connector between the original and new elements. When you select the connector, you create a new element connected to your initial element, complete with any subordinate objects such as Object Nodes and Action Pins.

If you drag the Quick Linker arrow onto an existing element on the diagram, only the connector menu displays, so that you select the type of connector to create between the two existing elements.

Display the Quick Linker Menus

There are two methods of accessing the Quick Linker menus.

Action	Detail
Click on Quick Linker	When you click on an element in a diagram, the Quick Linker arrow is

Arrow

displayed at the upper right corner of the element:

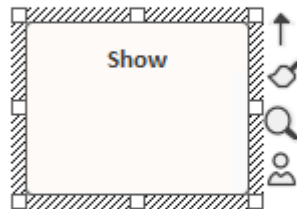

Click on this arrow and drag it in the direction in which you want to create the new connector and element. When you release the mouse button, the element menu displays. When you select an element type, the connector menu displays.

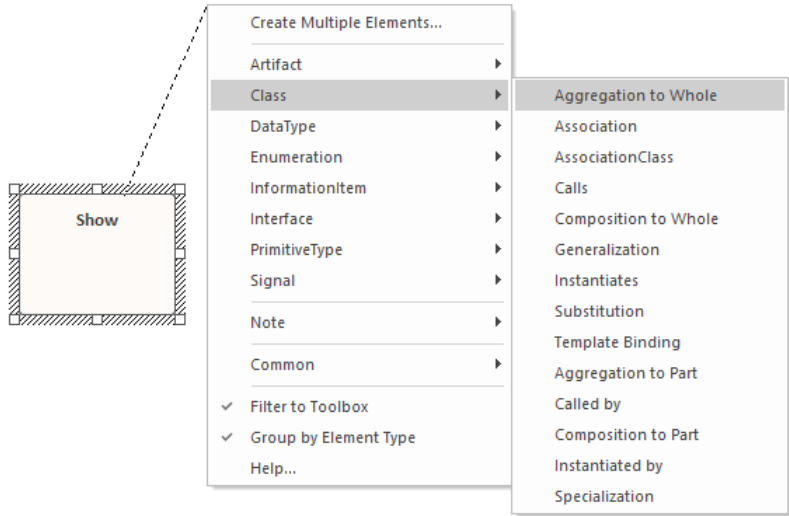
	 <p>The screenshot shows a diagram element labeled 'Show' with a dashed line pointing to a context menu. The menu has two columns. The left column lists element types: Create Multiple Elements..., Artifact, Class (highlighted), DataType, Enumeration, InformationItem, Interface, PrimitiveType, Signal, Note, and Common. The right column lists connector types: Aggregation to Whole (highlighted), Association, AssociationClass, Calls, Composition to Whole, Generalization, Instantiates, Substitution, Template Binding, Aggregation to Part, Called by, Composition to Part, Instantiated by, and Specialization. At the bottom of the menu are options: Filter to Toolbox, Group by Element Type, and Help...</p> <p>When you select the connector type, the element and connector are added to the diagram in the location in which you displayed the menus.</p>
<p>Press Ctrl+Shift+Arrow key</p>	<p>After selecting the element, press Ctrl+Shift and the keyboard arrow key for the direction in which you want to create the new connector and element (Right, Left, Up or Down).</p> <p>The element and connector menus display. When you select the type of connector, the new element and connector are created off the edge of the element appropriate to the arrow key you pressed. For example, if you press the</p>

	Right Arrow key, the new element is created to the right of the original element.
--	---

Notes

- On the initial (element) menu, the 'Create Multiple Elements' option displays the 'Create Multiple Elements' dialog, on which you specify a number of elements to create; the default entry is the base element and connector for the diagram type, but you can click on the drop-down arrow in each field and select other types of element and connector appropriate to the diagram type
- Also, the 'Filter to Toolbox' option, which defaults to selected, filters the list of elements and connectors to only those also available through the Toolbox page for the current diagram type; deselecting the option allows the full range of types of relationship and target element for the type of source element to be listed
- The 'Filter to Toolbox' option is not displayed if you are working on a diagram with an applied metamodel or view, such as an ArchiMate 3 Business Layer Application Usage diagram; such diagrams have a fixed element/connection set that cannot be altered
- When using the Ctrl+Shift+<arrow key> method on a Sequence diagram, you cannot use the Up or Down keys; the Right and Left keys create a connector to a Lifeline element

- When using the Ctrl+Shift+<arrow key> method on a Timing diagram, you cannot use the Right or Left keys
- If the connectors and elements suggested by the Quick Linker do not include the types you need, you can also create them from the Diagram Toolbox pages
- A Technology Developer can create new or different lists and combinations of elements and connectors

Create Connectors

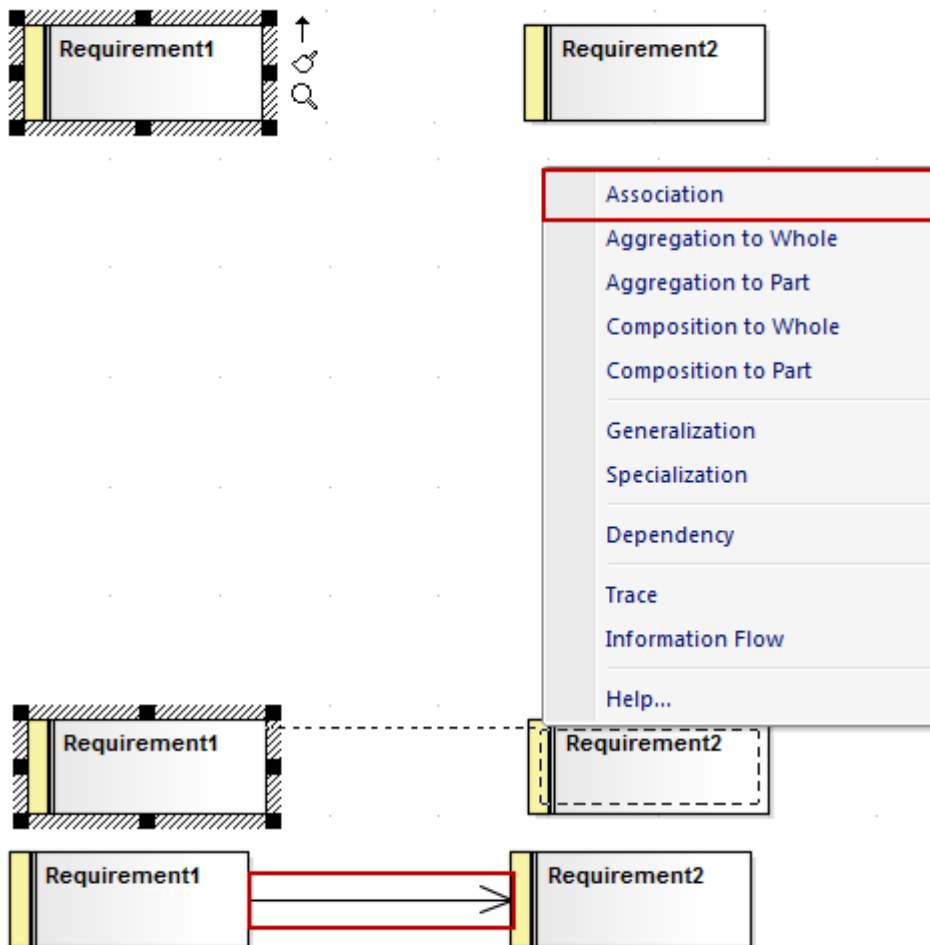

The connector list does not actually display until you release the mouse button over the target element; however, a dotted line shows where the connector would be at any point, and a hatched outline displays within the border of an element as you move the cursor onto it - this helps you identify where the connector should connect to, if there are many closely-arranged elements, Parts, Ports or other extensions.

The list contains the most appropriate, commonly-used types of connector for the source and target element types. If you want to use a different type of connector, select the appropriate Toolbox page, click on the required connector

and then on the source element, and drag across to the target element.

Notes

- You can quickly create a Notelink to attach a Note or Constraint to a connector, simply by dragging the Quick Linker arrow on the Note element onto the connector

Create New Elements

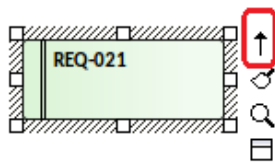

Click, drag and release

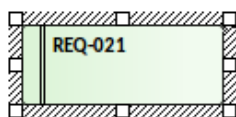

Choose connector type

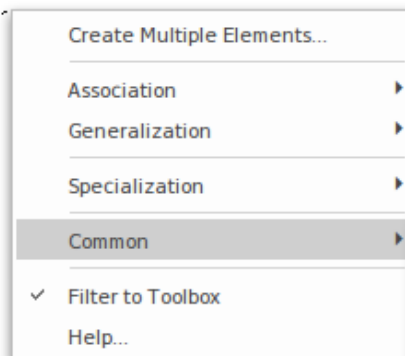

Choose element type

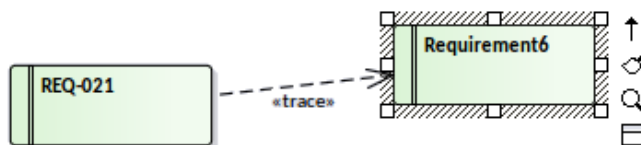
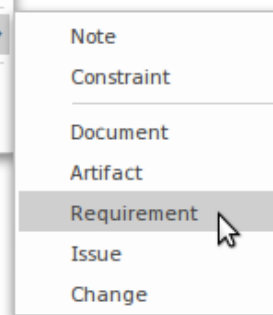

The connectors and elements listed on the two menus depend on the type of the element you initially selected; for example, if you click on the Quick Linker arrow for a Class, the options are not the same as if you clicked on the arrow for an Actor. However, in either case the menus show the most appropriate, commonly used connectors and target elements for that initial element; you can create other connectors and target elements by selecting them from the appropriate Toolbox page.

Certain types of element - such as Action and Artifact - are available in a range of subtypes. You can select which

subtype to create by holding down the Ctrl key as you select the main element type. For an:

- Action element, the 'New Action' dialog displays from which you select the Action subtype, such as CallOperation or SendObject
- Artifact element, a submenu displays from which you select the Artifact subtype, such as Report Specification or Checklist

Notes

- You can create a connector to an existing classifier from the Browser window, by pressing Shift while clicking on the type of connector; the 'Select existing element' dialog displays on which you browse for and select the element, then the connector and element are added to the diagram

The Context Buttons

When you select an element on a diagram, or add a new element, a number of small icons display off the *right* hand side of the element underneath the Quick Linker arrow (); for example:



These icons display context menus and/or toolbars of diagramming options or perform specific actions, to help you quickly edit the element you have highlighted. If you do not want to show or use these icons, you can prevent their display by deselecting the 'Show buttons for selected Object on diagram' checkbox on the 'Objects' page of the 'Preferences' dialog.

Also, if an element shown in the diagram is locked, and the 'Display Element Lock Status' option is selected in the 'Properties' dialog for the diagram, a locking indicator is displayed outside the top *left* hand corner of the element. The indicator is the same as the exclamation mark (!) against a locked element in the Browser window:

- Red if the element is under a full lock or locked by another user
- Blue if the element is under a lock set by yourself or by a user in the same User Group as yourself

You might also see, on the left hand side of the element, another floating icon (). This displays when:

- In the 'Diagram' tab of the Properties window for the

diagram, in the 'Connectors' section, the 'Show Feature Linker' checkbox is selected, and

- The element name or an operation, attribute or reception within the element is selected and highlighted

The icon helps you to create a relationship between the selected feature in one element and another element or a feature within it. See the *Feature Quick Linker* Help topic.

Icon Use

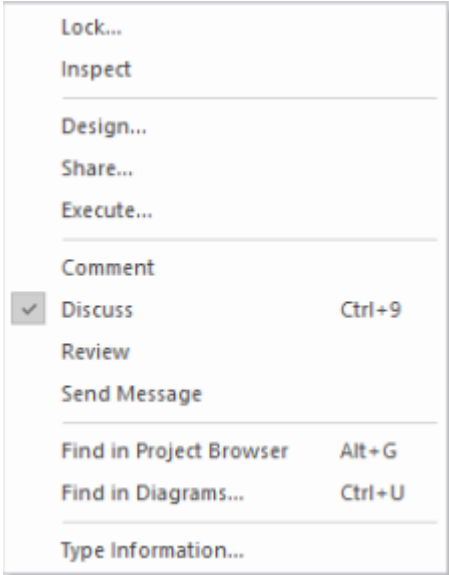
Icon	Action
	<p>Click on this icon to display a context menu of options for operating on the selected element or elements. The common set of options are as shown:</p>  <p>You can use these options to:</p> <ul style="list-style-type: none"> • Set a lock on the selected element • Display details of the element's

	<p>properties and characteristics on the 'Details' tab of the Inspector window</p> <ul style="list-style-type: none">• Open the Design, Collaborate and Execute Window Selectors, to select windows and dialogs to edit the element's properties and features• Open the Discuss & Review window at the 'Journal', 'Discuss' or 'Review' tabs, or the 'Model Message' dialog; if appropriate, an option is also provided to access the 'Chat' tab of the Chat & Mail window• Locate the element in the 'Project' tab of the Browser window, or in any other diagrams in which it is used• Display the Help topic describing the element type
	<p>Click on this icon to display a toolbar and context menu of options for operating on the element appearance, to change the appearance of the element. If you select the icon for a single element , the toolbar and options appear as shown:</p>

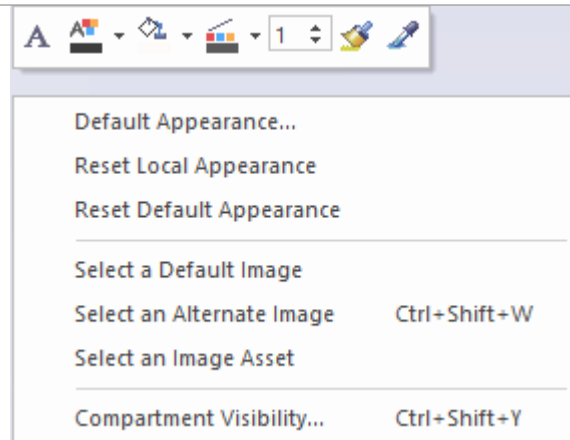

The toolbar icons, in order of display, enable you to set the element's text font, text color, fill color, border color, and border line width, or to set the element fill color to a previously-sampled color, or to sample (copy and store) the current element fill color.

The context menu options enable you to:

- Define the border, font and background colors and the border thickness for the selected element, as its default appearance wherever it is used
- Reapply the appearance of the element as specifically defined for that element on this diagram
- Reapply the defined default appearance of the element
- Change the element's appearance to either a new default image or an alternative image, using the Image Manager; this appearance applies to the element on all diagrams in which it is

used



- Display the 'Select Element' browser, and locate an Image Asset element containing the required image to use for the selected element
- Define which features and characteristics of the selected element are shown in compartments of the element on the diagram, using the 'Compartment Visibility' dialog
- For elements that do not have the default rectangle/compartments rendition, such as Use Cases and Actors, toggle display of the element between their default shape and rectangular notation

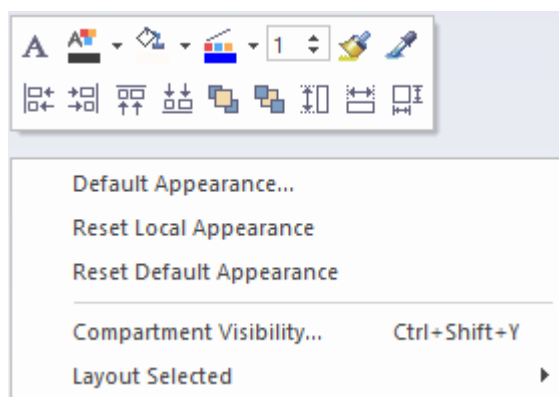



If you select this icon on an element within a group of selected elements, further options are listed, as shown:





The additional options on the toolbar enable you to:

- Align the left, right, bottom or top

	<p>borders of the elements in the group with the appropriate edge of the selected element</p> <ul style="list-style-type: none"> • Bring the selected elements further forward or further back in the diagram relative to the unselected elements • Make all elements in the group the same height as the selected element, the same width, or both <p>An additional context menu option - 'Layout Selected' - enables you to apply one of the ten diagram layout styles (other than Fan Relations), or to apply a style with finer control through the Layout Tools window.</p>
	<p>If an element has a linked diagram, such as child composite diagram, click on this icon off the right hand side of the element - an image of the linked diagram is shown in a floating Diagram pop-up window; click off the diagram or press the Backslash key to close the window again or double-click in the Diagram pop-up window to open the diagram in the main view area.</p>
	<p>(Displays if the diagram has the 'Custom Styles' option selected.) Click on this icon</p>

	<p>to display a toolbar for applying custom diagram style options to the selected element or elements. The toolbar enables you to set the element:</p> <ul style="list-style-type: none"> • Shape • Fill opacity • Name and Notes text position and orientation • Icon size, position and padding • Border line style • Outline stacking direction and the number of outlines in the stack
	<p>Click on this icon to rotate a Fork/Join element from vertical to horizontal or vice-versa.</p>
	<p>On a Package element, displays two further icons to generate:</p> <ul style="list-style-type: none"> • A document file using the 'Generate Documentation' dialog, or a • Web page document using the 'Publish as HTML' dialog
	<p>(Or ) Click on this icon to toggle an Activity Partition between vertical and horizontal.</p>

	<p>Indicates that the Interaction Fragment currently contains messages; in this state you can:</p> <ul style="list-style-type: none">• Move the fragment vertically, but not horizontally; all elements and messages below the fragment move up or down by the same amount• Resize the fragment to larger than the contained messages/elements, but not smaller <p>This is the default condition when you open or reload a diagram containing a fragment. You can click on the icon to toggle to 'move freely' mode.</p>
	<p>Indicates that the Interaction Fragment can be moved independently of the Messages or other elements contained within the fragment.</p> <p>This is the default condition when you first create the fragment. You can click on the icon to toggle to 'contains messages' mode (earlier).</p>

The Context Menu

You can perform a wide range of tasks and operations on a diagram and its contents. To access and initiate these operations, you select options from the diagram's context menu.

Access

Context Menu	Right-click on the diagram background
--------------	---------------------------------------

Options

Option	Action
Specialize	<p>Provides two sets of functions:</p> <ul style="list-style-type: none">• Scripts - scripts created using the Scripting facility, to be executed on diagrams; click on a script name to execute it (this option is not shown if no appropriate scripts have been created)• Extensions - a list of the enabled technologies on the system, each of

	<p>which provides options for performing technology-specific operations on the diagram</p>
Collaborate	<p>Select this option to display a short menu of options to exchange electronic notes on the selected diagram with team colleagues, in the form of Reviews, Discussions and, if User Security is enabled, Chats and Model Mail messages.</p> <p>Options for setting automatic refresh intervals can also be found here.</p>
Switch View	<p>Provides options to display the diagram contents in a number of alternative formats:</p> <ul style="list-style-type: none">• Graphical View - the standard graphical display format• List View - a tabular, editable list of elements• Gantt View - shows the Project Resources assigned to each element• Specification View - each element is represented by a text description in the Specification Manager• Relation Matrix View - a table showing the relationships between the diagram

	<p>elements</p> <ul style="list-style-type: none"> • Construct View - displays the resources and progress of work on the diagram elements • Inline Specification view - when in the graphical display format, select between displaying and hiding a Specification view of the diagram elements in the right half of the diagram
<p>Show All Bookmark Values / Hide All Bookmark Values</p>	<p>It is possible to assign bookmarks with numerical or text values to elements on a diagram. Each bookmark is displayed as a red circle containing the bookmark value, just above the parent element. These two menu options reveal or hide all the assigned bookmarks on the diagram.</p>
<p>Properties</p>	<p>Displays the diagram 'Properties' dialog, through which you can define properties including name, author and version information, zoom factor, paper size and layout, diagram notes and various appearance attributes. Some properties influence the display of the diagram and some are logical attributes that appear in the documentation.</p>

<p>Validate Diagram</p>	<p>(In a Business Process diagram)</p> <p>Validates the diagram, and the elements and connectors within the diagram, for correctness.</p> <p>The results of the validation are displayed in a tab of the System Output window.</p>
<p>Insert</p>	<p>Displays a short menu of options for adding objects to the diagram:</p> <ul style="list-style-type: none"> • Other Element - displays the Select Element browser, through which you locate and select an existing element to add to the diagram as a linked element • Store Document(s) in Model - displays the default file browser, through which you locate a file to store as a File Artifact element in the model and in the diagram; double-click on the Artifact to show the file contents • Link to Document(s) in File System - again displays the default file browser, but when you select a file the system creates a hyperlink to that file • Show Toolbox - Select this option to display the Diagram Toolbox at the appropriate pages for the type of diagram, if the Toolbox is not already displayed

<p>Paste</p>	<p>Displays a short menu of options for pasting copied elements or images into the diagram.</p> <ul style="list-style-type: none"> • Element(s) as Link - paste copied elements into the diagram as links to the original element(s) • Element(s) as New - paste copied elements into the diagram as new elements • Image from Clipboard - paste an image held on the clipboard into the diagram (shortcut: Ctrl+Shift+Insert) • Image Asset - paste an image held on the clipboard into the diagram as a new Image Asset Artifact
<p>Hide Diagram Frame / Show Diagram Frame</p>	<p>This option applies to these diagram types when the diagram is a composite diagram:</p> <ul style="list-style-type: none"> • Any SysML type • UML StateMachine <p>The elements on the diagram are automatically enclosed in a Diagram Frame representing the element that owns the diagram. Click on the options to hide and redisplay this Diagram Frame.</p> <p>On a SysML diagram, the frame will:</p> <ul style="list-style-type: none"> • Auto-resize to fit the bounds of the

	<p>diagram if the frame is non-selectable, expanding from its default size but not shrinking smaller</p> <p>Note that diagrams showing Diagram Frames applied using release 14.0 or later of Enterprise Architect will draw the parent object on the diagram when opened using a release of Enterprise Architect earlier than release 14.0.</p>
Interaction Parameters	(On an Interaction diagram.) Displays the 'Interaction Occurrence' dialog, on which you define the arguments, return value and attribute to create an Interaction Occurrence.
Supress Activations	(On a Sequence diagram.) Hides or redisplayes the activation rectangles on the Lifeline elements of the diagram.
Set Top Margin	(On a Sequence diagram.) Displays the 'Top Margin' dialog, through which you change the space above the Lifeline elements on the diagram to between 30 and 250 units.
Sequence Communication Messages	(On a Communication diagram.) Displays the 'Communication Messages' dialog, through which you can change the order

	of the communication messages in the current diagram.
Synchronize Structural Elements	Applies to a SysML Internal Block diagram or a SysML Parametric diagram, where it shows all structural elements (such as Ports and Parts) relating to the Block that owns this diagram. This command will also generate Properties defined by existing Association connectors.
Swimlanes and Matrix	Displays the 'Swimlanes and Matrix' dialog for diagrams, through which you can add or modify Swimlanes or a Swimlanes Matrix on the diagram.
Roadmap	Displays the 'Roadmap options' dialog, which you use to define a Roadmap Timeline on the diagram.
Kanban	Displays the 'Kanban' dialog, through which you can define the structure, content and appearance of a new or existing Kanban diagram, or to convert a different type of diagram to a Kanban diagram.
Clear all	Clears all selected checkboxes within

Checklists	every Checklist Artifact element in the current diagram.
Set diagram flow direction	<p>(On a Business Process diagram) Displays a short menu of options to set the flow orientation of the diagram. Click on:</p> <ul style="list-style-type: none"> • None (the default, no specific orientation set) • Horizontal (diagram flows across the page, Pool and Lane elements occupy the full width of the diagram), or • Vertical (diagram flows down the page, Pool and Lane elements occupy the full height of the diagram)
Statechart Editor	<p>(For a StateMachine diagram.) Displays a short list of options to switch the current format of the diagram to:</p> <ul style="list-style-type: none"> • Diagram • Table (State-Next State) • Table (State-Trigger) or • Table (Trigger-State)
Lock Diagram	<p>Select this option to lock the diagram to protect it from inadvertent changes. This does not apply in the Corporate, Unified and Ultimate Editions if security</p>

	is enabled, in which case you lock the model elements.
Find in Project Browser	Locates and highlights the current diagram in the Browser window. Shortcut: Shift+Alt+G
Execute Simulation	(On a behavioral diagram.) Displays a short menu of options for performing a model simulation: <ul style="list-style-type: none"> • Interpreted simulation - perform dynamic execution of a simulation (Corporate and extended Editions) • Manual simulation - step through a simulation manually (the only option available in the Professional Edition) • Using Script - if simulation scripts exist for the diagram, list the scripts available; if no scripts exist, the option does not display
Save Current Changes	Saves any changes to the current diagram. Shortcut: Ctrl+S
Help	Displays the Help topic on this type of diagram.

Notes

- Not all the menu options described appear on the context menu of every diagram

Diagram Layers

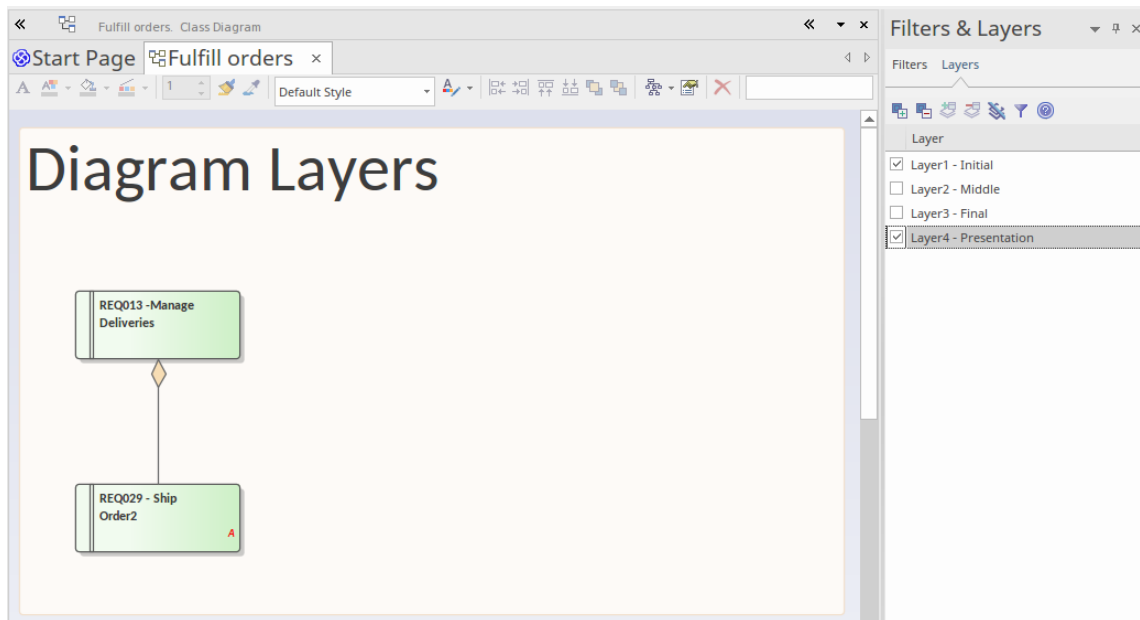

Diagram Layers provide a way of creating and viewing segments of a diagram to represent any concept that is the basis for separating or grouping the elements on that diagram. The layers can be compared to transparencies laid on top of one another in a stack, as in paper-based encyclopedias where, for example, a base image of a human skeleton would have a transparent sheet showing the arteries laid on top, then one for veins and another for nerves. The analogous process with Enterprise Architect's Diagram Layers is to reveal parts of any diagram, including Business Process Models, Architecture diagrams, Kanban diagrams or Roadmap diagrams. The tool has the added flexibility of being able to selectively apply any subset of the layers, which can't, of course, be done with the encyclopedia transparencies. The tool also has the ability to bring a selected layer to the foreground while showing the other layers with reduced opacity. Diagram Layers will be a

welcomed tool for people who need to present complex models to an audience, creating an easy-to-understand narrative built up in stages rather than confusing the audience with the complete diagram from the start.

Diagram Layers - like the related Diagram Filters - can be used to hide or expose parts of any diagram. Filters are applied using element metadata such as status or complexity, whereas Layers are applied using any ad hoc criterion for the separation of the elements; for example, items to be focused on in a workshop or elements of a particular architectural style. Layers can be used to separate elements in architecture diagrams to show strategic, tactical or implementation intent, or to show particular sequences of activations in a Sequence diagram, or to show a time-ordered sequence in a Business Process model, and much more.

An important difference between Filters and Layers is that Filters are defined at a meta-level and so can be applied to any diagram in the repository. So, for example, a Filter that hides all elements except critical requirements can work on a business level diagram in Project A and a technical level diagram in Project B. Layers, on the other hand, are intentionally defined on and for a specific diagram and cannot be applied to other diagrams. Advanced modelers might want to use Layers and Filters together to create visualizations of the underlying diagrams, remembering that the definitions of Filters apply at the level of the repository but their usage and application with Layers apply to a user's view of a diagram. Diagram legends can also be used in

conjunction with both Layers and Filters to assist in improving the narrative of the diagram.

Access

<p>Ribbon</p>	<p>Layout > Tools > Filters & Layers > Layers or Explore > Portals > Windows > Diagram > Diagram Filters > Layers</p>
<p>Keyboard Shortcuts</p>	<p>A+1 > Diagram Layers > Layers</p>

Options

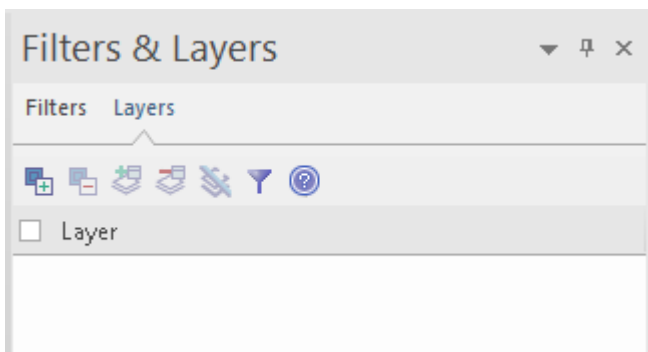

The icons in this table are described in order of use, not in order of display in the toolbar.

Option	Action
<p>Create New</p>	<p>Simply click on this icon to display a</p>

<p>Layer</p>	<p>selected checkbox and the text 'Layer <i>n</i>'.</p>  <p>Overtyping the text with whatever name you want to apply to this layer of elements.</p> <p>The checkbox is selected so that the elements in the layer are shown on the diagram. If you clear the checkbox the layer is not active and the elements within it are not shown.</p> <p>You now select elements to add to the new layer.</p>
<p>Add elements to layer</p>	<p>On the diagram, select the element or elements to show or hide using a layer. Then click on the name of the layer, and on this icon. The icon is enabled when the elements and layer are selected.</p> <p>If you now clear the layer checkbox, the elements assigned to it are hidden on the diagram. If you select the checkbox, those elements are shown again.</p>
<p>Filter by layer</p>	<p>With a layer checkbox selected, click on this icon to fade all elements NOT in the layer, leaving the selected layer displayed in clear. Click on the icon again to restore all elements to full display.</p>

<p>Remove selected elements from layer</p>	<p>In the diagram, select the elements that you no longer want to include in the layer. Then click on the layer name and click on this icon.</p> <p>When you clear the checkbox against the layer name the selected elements are no longer hidden on the diagram, and when you select the layer and click on the Filter icon, those elements are faded.</p>
<p>Clear all elements from layer</p>	<p>Simply click on the layer name and click on this icon. All elements assigned to the layer are cleared from it. If the layer has no assigned elements, the icon is not enabled.</p>
<p>Delete layer</p>	<p>Click on the layer name and on this icon to remove the layer from the window. Any assigned elements display as normal.</p>
<p>Layer</p>	<p>Select this check box to set the filter state for all filters in the list.</p>
<p>Help</p>	<p>Display this Help topic.</p>

Notes

- Layers operate on elements; connectors between elements are hidden or filtered in if the target and/or source element is assigned to the selected layer
- If a diagram layer is selected, it will remain selected as you click out of and into the diagram
- If a layer is hidden, the elements in it cannot be selected

Diagram Filters

Using Diagram Filters (Dynamic Visual filters), you can modify the display of diagram components so that the required items are immediately identified, without damaging the structure and integrity of the model. The filters operate on elements, connectors or Tagged Values according to properties such as Author, Status, Date Created or Stereotype Value and, for connectors, whether the connector is hidden or visible. Filters are stored against the model, so a filter you create is available to other users of the model; however, use of a filter is specific to the user, so your use of a filter does not affect another user's view of the diagram.

Access

When you first display the Filters & Layers window at the 'Filters' tab, the filter groups are collapsed. Click on the white arrow head to show the defined filters.

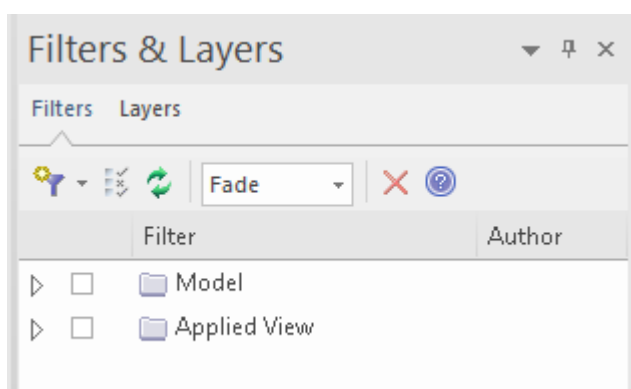

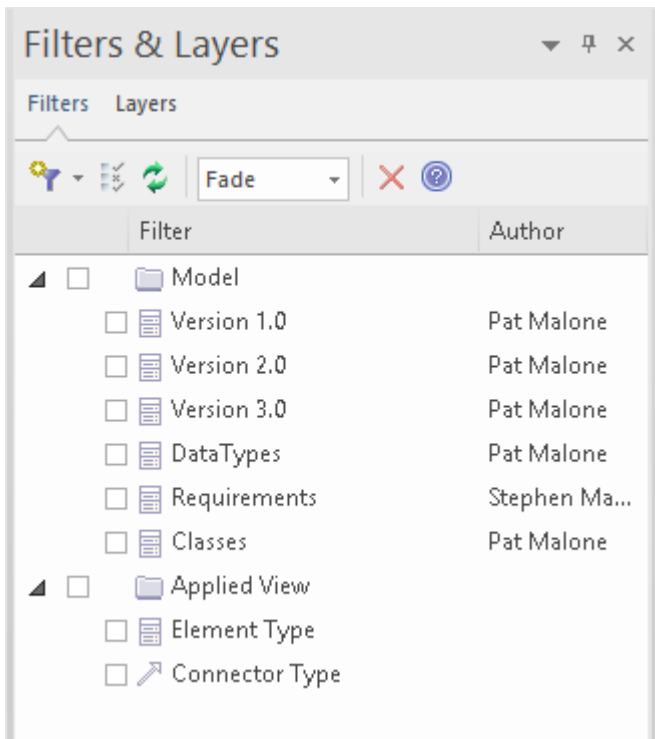

<p>Ribbon</p>	<p>Layout > Tools > Filters and Layers > Filters or Explore > Portals > Windows > Diagram > Diagram Filters > Filters</p>
<p>Keyboard Shortcuts</p>	<p>A+1 > Diagram Filters > Filters</p>

Applying Diagram Filters

You can use Diagram Filters singly, in sequence, or in combination to tailor the display of diagrams to show:

- Information for different users, so that - for example - technical staff and stakeholders each can apply filters that highlight the information pertinent to them

- What elements have been recently developed or changed
- Which part of a model was developed by a particular person
- Which parts of a diagram are at a particular phase, status or version

Examples of ways in which you might apply filtering include:

- Setting up a filter for immediate use on a diagram, and modifying that filter as you review the diagram so that you highlight elements with different values for the same properties - perhaps, by filtering on Phase, to compare 'As-Is' and 'To-Be' elements
- Setting up a filter and leaving it active so that all diagrams you display are automatically filtered the same way
- Setting up a series of filters to use:
 - in one or more sequences to progressively highlight a diminishing set of items, or
 - alternately, to highlight contrasting views of the diagram
- Grouping filters so that their combined results identify objects that meet the characteristics of each filter and indicate an 'overview' status as well; for example, 'Work In Progress' plus 'Work Not Started' show objects in each category at the same time, under the group filter 'Work Not Completed'

Filters for elements can also be applied to the Package Browser and Diagram List.

The 'Diagram Filters' context menu (right-click on the body

of the window) provides an option for toggling between the filters and simple context filtering of diagrams; if you select the 'Context Filtering' option, the Diagram Filters are disabled and the contents of the diagram are grayed-out, except for a selected element and those elements directly related to it.

Facilities

Facility	Detail
Developing Filters	<p>You create and define as many filters as you require, setting up each filter by defining which element, connector or Tagged Value properties to specifically check for and (depending on how you set up the filter parameters) whether to include or exclude elements or connectors having particular property values.</p> <p>You cannot combine element, connector and/or Tagged Value <i>properties</i> in one filter, but you can apply any combination of element filter, connector filter and/or Tagged Value filter to a diagram at the same time, individually or as a grouped filter.</p> <p>You can select to:</p>

	<ul style="list-style-type: none"> • Mute the excluded items in Gray Scale, or Fade the display color • Hide the excluded items completely, or • Select and highlight (with a hashed line) the included items
<p>Filter Effect - Gray Scale, Fade or Hide</p>	<p>If you select 'Gray Scale', 'Fade' or 'Hide', the action of the filters is to exclude items that do not match the parameters rather than include items that do.</p> <p>If, for example, you selected to filter on element name, looking for elements with the word 'Class' in the name, the filter would apply this logic:</p> <p style="padding-left: 40px;">Does 'Name' contain string 'Class'? If 'No', apply effect; if 'Yes', take no action.</p> <p>The elements you want are therefore what is left on the diagram, rather than what was operated on.</p> <p>The filter effect remains in force while you do other work on the diagram, until such time as you disable the filter.</p>
<p>Filter Effect - Highlight</p>	<p>If you click on 'Select', the logic is reversed:</p> <p style="padding-left: 40px;">Does 'Name' contain string 'Class'? If 'No', take no action. If 'Yes', apply effect.</p> <p>In this case, the filter effect is not</p>

permanent, and clicking off the items deselects them.

This effect is excellent for selecting items having the same characteristics across a large diagram, to be processed in a single task; instead of having to locate the items and select them with Shift+click individually, you can apply the filter.

If you inadvertently lose the selection by clicking off the items, you can get it back again almost immediately by re-applying the filter.

Work With Diagram Filters

You can modify the display of objects on a diagram using Diagram Filters, which you create and use through the Filters & Layers window. This window is dockable, so you can move it around or 'fix' it next to the Diagram View while you activate, deactivate and edit the filters.

Access

Ribbon	Layout > Tools > Filters and Layers > Filters or Explore > Portals > Windows > Diagram > Diagram Filters > Filters
Keyboard Shortcuts	A+1 > Diagram Filters > Filters

Create a single filter to be applied to your diagrams

Step	Action
1	Perform one of these actions:

- On the Diagram Filter toolbar, click on the 'New Filter' icon - the first on the left
- Right-click on the list panel and select the 'New Filter' option

The 'Create New Diagram Filter' dialog displays.

2 In the 'Enter Filter Name' field, type a name for the filter, then click on the OK button.

The 'Diagram Filter' dialog displays.

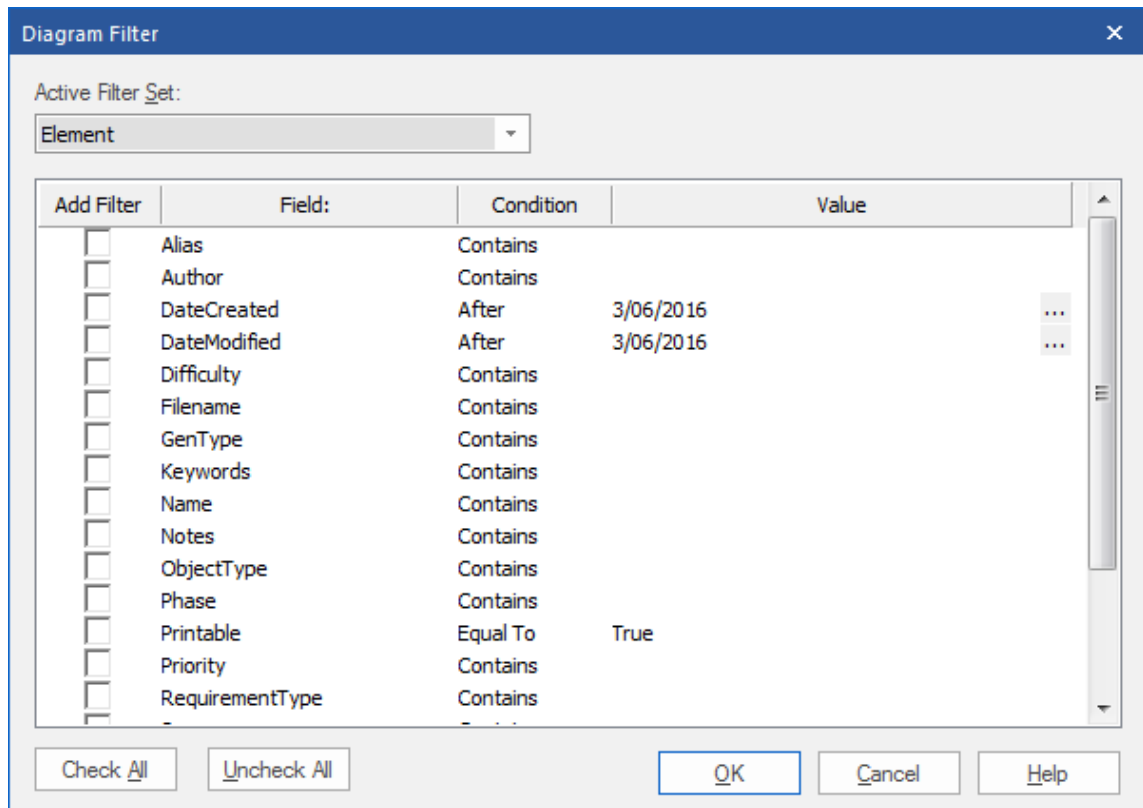

3 In the 'Active Filter Set' field, either:

- Use the default value of 'Element' or
- Click on the drop-down arrow and select 'Connector' or 'TagValue'

The body of the dialog displays a list of properties of

	elements, connectors or Tagged Values.
4	Scroll through the properties to filter on, and select the checkbox against each property you require.
5	For each property, click on the 'Condition' field and select, from the drop-down list, the comparison condition to be applied. Consider how the combination of 'Condition - Equal To / Not Equal To' and 'Filter Effect' might affect the results on the diagram.
6	For each property, double-click on the 'Value' field and type or select any specific value to filter on.
7	Click on the OK button to save the filter and return to the Filters & Layers window. Unless you have specifically created the filter in a Filter Group, the filter is listed underneath the default Model group at the top of the window.

Create a Filter Group

Step	Action

1	<p>In the Filters & Layers window toolbar, click on the drop-down arrow next to the Filter icon and select the 'New Filter Grouping' option.</p> <p>The 'Create New Diagram Filter Grouping' dialog displays.</p>
2	<p>In the 'Enter Filter Name' field, type the name of the filter group, and click on the OK button.</p> <p>The filter group is added to the end of the list in the Filters & Layers window, and the 'Create New Diagram Filter' dialog displays for you to add a new filter to the filter group.</p>
3	<p>Define the new filter in the group as described in the <i>Create a single filter to be applied to your diagrams</i> table. You can apply that procedure to define the other filters for the group, clicking on the group name and then on the 'New Filter' option to start.</p> <p>Alternatively, you can copy or cut an existing filter from the Model list or from another filter group, and paste that filter into the new group. Right-click on the source filter and select the 'Cut' or 'Copy' option, then right-click on the target group and select the 'Paste' option.</p>

Other Operations

Operation	Detail
Edit a Filter	<p>To edit an existing filter on the Filters & Layers window, either:</p> <ul style="list-style-type: none"> • Double-click on the filter name • Click on the filter name and select the 'Properties' icon from the toolbar (the second icon from the left), or • Right-click on the name and select the 'Properties' option <p>The 'Diagram Filter' dialog displays; adjust the filtered fields as described in the <i>Create a single filter to be applied to your diagrams</i> table.</p>
Change the name of the Filter or Filter Group	<p>Right-click on the name and select the 'Change Name' option.</p> <p>The appropriate 'Create New Diagram Filter ...' dialog displays.</p> <p>Type over the existing name with the new name, and click on the OK button.</p>
Define how filters in a group combine	<p>When you define two or more filters in a filter group, they default to operating in combination, with an AND relationship. That is, an object must satisfy the criteria of all the selected filters in the group before being operated on.</p>

	<p>You can change this to an OR relationship, where the object must satisfy the criteria of any of the filters before being operated on. To set the relationship of the group filters to OR (or change it back from OR to AND):</p> <ol style="list-style-type: none">1. Right-click on the filter group name and select the 'Properties' option. The 'Set logical operator for Filter Grouping' dialog displays.2. In the 'Operator' field, click on the drop-down arrow and select the required value - OR or AND.3. Click on the OK button.
Set Effect of Filters	<p>The filter effect applies to all filters in the Filters & Layers window. To set how your filters identify selected items on your diagrams, click on the drop-down arrow of the toolbar 'Filter Effect' field, and select one of these options:</p> <ul style="list-style-type: none">• Fade - display all items that do not match the filter criteria in a pale version of the diagram background color• Gray Scale - display all items that do not match the filter criteria in pale gray• Hide - conceal all items that do not

	<p>match the filter criteria</p> <ul style="list-style-type: none"> • Select - select and highlight (with a hashed line) all those items that do match the filter criteria <p>If the filter is for elements in the Package Browser or Diagram List, note that the 'Select' filter effect cannot show up in this context.</p>
<p>Enable Filters</p>	<p>To enable a filter so that it takes immediate effect on your diagrams, select the checkbox against the filter name.</p> <p>You can select more than one filter at a time, to combine their effects.</p> <p>For a Filter Group, if you select the group checkbox all filters in the group are selected. You can then, if necessary, disable individual filters in the group.</p>
<p>Disable/Clear Filters</p>	<p>To disable a filter and clear the effect of the filter on the diagram so that it displays in full, clear the checkbox.</p> <p>To disable all filters, either:</p> <ul style="list-style-type: none"> • Click on the 'Reload Filters' icon in the toolbar (third option from the left), or • Right-click on the list panel and select the 'Reload Filters' option

<p>Copy or Move a Filter between Filter Groups</p>	<p>To add an existing filter to another Filter Group, right-click on the filter and select the 'Copy' or 'Move' option as appropriate. Then right-click on the target Filter Group and select the 'Paste' option. If you are moving a filter, it is not removed from the source group until it has been pasted to the target group. You cannot move a Filter Group or add one group to another.</p>
<p>Toggle between Diagram Filters and Context Filtering</p>	<p>To disable the filters you have defined and simply highlight a selected element and its immediate relatives, right-click on the Filters & Layers window background itself and select the 'Context Filtering' option.</p> <p>To re-enable the Diagram Filter effects, display the Filters & Layers window again and deselect the 'Context Filtering' option.</p>
<p>Delete a Filter</p>	<p>To remove a filter or filter group from the Filters & Layers window, either:</p> <ul style="list-style-type: none"> • Click on the filter name and click on the Delete icon in the toolbar, or • Right-click on the filter name and select the 'Delete Filter' option <p>A prompt displays to confirm the</p>

	deletion.
--	-----------

Context Filter a Diagram

As you review a modeling diagram, it is possible to click on any element on the diagram and show only those elements that are directly related to the selected element. All other elements are grayed out until you click on the diagram background.

Access

Ribbon	Layout > Filter : Choose 'Relationships' from the drop-down list Layout > Tools > Filters and Layers : Right-click dialog background > Context Filtering Explore > Portals > Windows > Diagram > Filters and Layers : Right-click dialog background > Context Filtering
--------	---

Notes

- When you set the option and click on an element, any elements on the diagram that are not directly related to the selected element are grayed out
- Setting the context filter applies to all diagrams that are open; you can select an element on each opened (floating)

diagram and examine their relationships together

- To clear the filtering (but not turn Context Filtering off) press the Esc key
- To select the next element in a direct chain or group of relationships on a diagram, press the Tab key; the Tab key does not take you out of the element group
- To select the next element on the diagram, and display that element's related elements, use the arrow keys to move up, down, left or right to the next element in that direction; when moving left or right, the selection tends to be upwards rather than downwards
- When you enable the option on the Filters & Layers window, it overrides the Diagram Filters settings; to use the Diagram Filters again, toggle the 'Context Filtering' option off
- Context filtering can be made even more useful by highlighting the incoming and outgoing relationships in different colors, by pressing and holding the L key on the selected element

Diagram Legends

A Diagram Legend is an element that you can add to your diagram to provide information about the colors and/or line thicknesses and styles that have been used in the current diagram, where those colors and other styles have some particular meaning. For example, it is common to have a Legend that indicates a particular color represents a particular element status or version. Connectors might be colored according to whether they are of a particular type or direction. Element borders might be thicker or thinner according to some other property or condition.

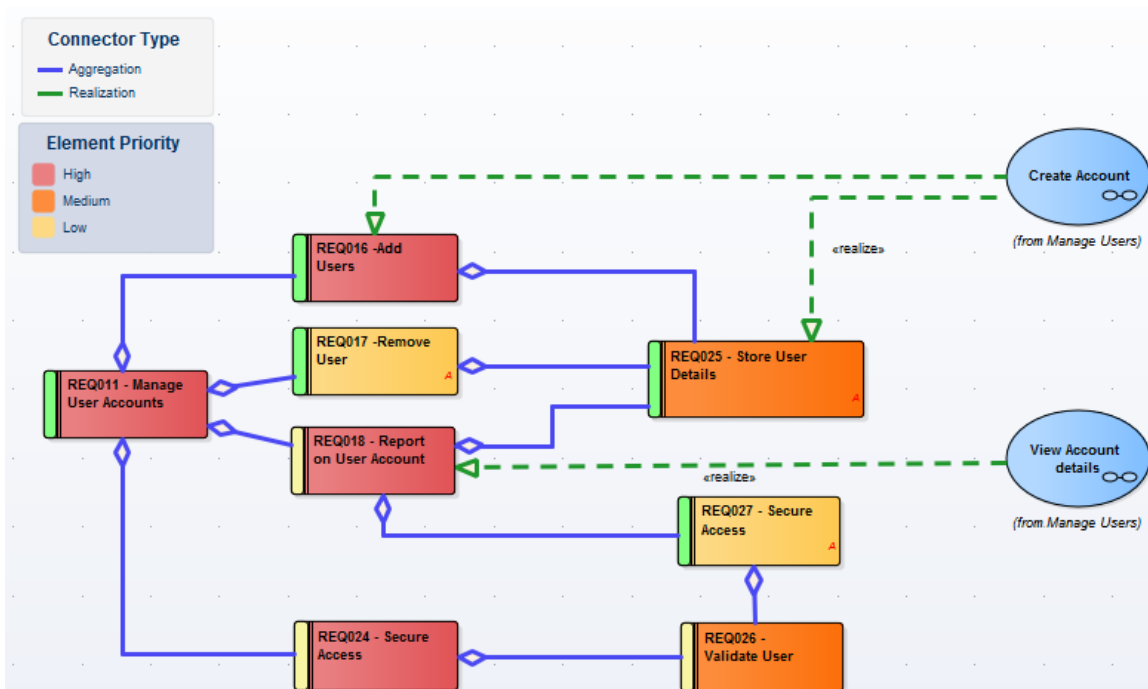

Legends have additional capabilities, including the ability to auto color elements in different ways and according to different rules and filters. Legends are classified as elements and will be listed in the Browser window; however, they are not shown in contents of a Package displayed on a diagram.

The Help topics *Create Legends*, *Legend Properties* and *Legend Key* detail the mechanics of setting up your Legend, but first a quick overview.

Simple Legend

Simple Legends provide a manually configured key set that references the various styles used in the diagram. For example, an element might be manually set to fill with the color red, and the Legend can be configured to indicate that red means 'Overdue'. This is a very useful way of providing information about the conventions and styles used and the meanings that they represent. You can create and add as many Simple Legends as you need to your diagram.

Auto Legend

An Auto Legend is one that has the 'Auto Color' checkbox ticked. This puts the Legend into a more 'active' mode, and will automatically adjust the diagram to apply a color or characteristic according to the object's defined feature or status.

For example, it is possible to set up a Legend that will set all Requirement elements that have a Status of 'Validated' on a diagram to a specific fill color. The color will be applied automatically to the filtered element set with no manual intervention. This is a very useful mechanism for providing a dynamic view of a diagram and exposing inner attributes, properties or statuses in real-time. This technique can be

applied to element fill, element border color, element line thickness, connector line thickness and connector color.

It is important to remember that when the auto-color property is set, the change in element appearance is only dynamically applied on the Legend's diagram, and is not a permanent change. If you de-activate the Legend, all elements affected will return to their base appearance.

Stacked (Multiple) Legend

What is even more helpful is the ability to 'Stack' multiple auto-color Legends on a diagram and let Enterprise Architect dynamically color according to the union of all the different Legend conditions. For example, this approach lets you dynamically color or affect the appearance of Requirements according to Status, Components according to Phase, Use Cases according to Version, and so on. By stacking multiple Legends you have the ability to create a very rich and detailed diagram that conveys a huge amount of information in its dynamically applied styles.

Getting Started with Legends

These topics provide the necessary information for creating and configuring Legends on diagrams. Keep in mind that you can use Legends at any level, from the Simple type to the more dynamic Auto-Coloring and Stacked styles.

Create Legends

A Legend element on a diagram provides a visual key to the colors and line thicknesses you have used to identify elements and/or connectors that have particular meaning. The Legend can reflect a simple, manually-applied convention such as all elements concerned with a management system being shaded in blue, or all outgoing connectors colored red. However, the Auto-Color Legends can also automatically apply the style to elements or connectors having a chosen property, such as a specific phase, stereotype or type.

The Legend lists the element appearance conventions first, and the connector appearance conventions underneath.

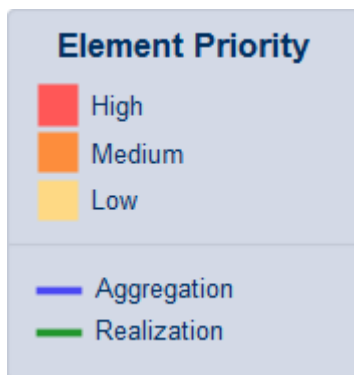

You work on a Legend element in two stages: first create and define the Legend element itself, then define the appearance styles as displayed on the diagram.

Access

Toolbox	Drag the Diagram Legend icon () from
---------	---

	the 'Common' page of the Toolbox onto the diagram
Toolbar	Click the 'New Diagram Legend' icon () on the UML Elements toolbar

Multiple Legends

In many cases a single Legend will be sufficient to define the styles and their meanings within the current diagram. In some situations though, it is much more interesting and effective to use multiple Legends, especially if the Legends are Auto-Coloring. Situations where multiple Legends are useful include:

- If you want to use more than one automatically-applied style (Stacked Legends)
- If you have used several manually-applied styles, and you want to identify them in small groups
- Where the diagram is large, and you want to reproduce the same key where it can be referred to in different sections of the diagram

Because a single Legend is limited to a single filter per element type (or all types), such as a range of Status values for Requirements, multiple Legends are a good way of addressing different filters on different element types. A second Legend, for example, might indicate that all Components are colored according to a Version or Phase

number.

You can have conditions that operate on different properties, by defining those conditions in separate Legend elements. However, check that the conventions in the two Legends operate on different display characteristics; for example, one Legend setting Class fill color whilst the other sets Class border width. They cannot both act on the same property, such as Class fill color. If they do, the most recently-created Legend (or the one with the highest Z-order) over-rides the previous Legend.

Legend Properties

The 'Legend Properties' dialog defines the appearance of the Legend element itself, such as its background color, title text color and size, and border color. If you choose to use default colors, these are derived from the 'Preferences' dialog, 'Standard Colors' page.

Access

The 'Style Options' dialog for a Legend element can be displayed using any of the methods outlined here.

<p>Ribbon</p>	<p>Design > Element > Editors > Properties Dialog : Style Options Design > Element > Editors > Properties > Legend : Style Options</p>
<p>Other</p>	<p>Double-click Legend element: Style Options</p>

Define properties of a Legend

Option	Action
<p>Heading Size</p>	<p>Either:</p>

	<ul style="list-style-type: none"> • Overtyping the font size of the Legend Title text with a different value, or • Clicking on the 'spinner' arrows to increase or decrease the font size
Font Color	<p>Click on the drop-down arrow and select one of the standard font colors for the Legend Title text.</p> <p>If you want to use a non-standard color, click on the More Colors button and either select from the larger pallet or define a custom color.</p>
Background	<p>Click on the down arrow and select one of the standard colors as the background fill color of the Legend element.</p> <p>If you want to use a non-standard color, click on the More Colors button and either select from the larger pallet or define a custom color.</p>
Border Color	<p>Click on the down arrow and select one of the standard colors as the color of the border lines of the Legend element.</p> <p>If you want to use a non-standard color, click on the More Colors button and either select from the larger pallet or define a custom color.</p>

OK button	Click on this button to save your changes and close the dialog.
Cancel button	Click on this button to abandon any changes and close the dialog.

Notes

- As you define the properties of the element, the changes are reflected in the preview window to the right of the value fields

Legend Key

A Legend element on a diagram provides a key to the element and connector appearance conventions used on that diagram. Each element or connector convention is separately defined within the Legend element, using the 'Legend' dialog and the 'Element' and 'Connector' tabs. If you want to present the Legend items in a specific sequence, you can adjust the order in which the items are listed on the element.

You can create more than one Legend on a diagram, to represent particular combinations of conditions.

Access

The 'Properties' dialog for a selected Legend element can be displayed using any of the methods outlined here.

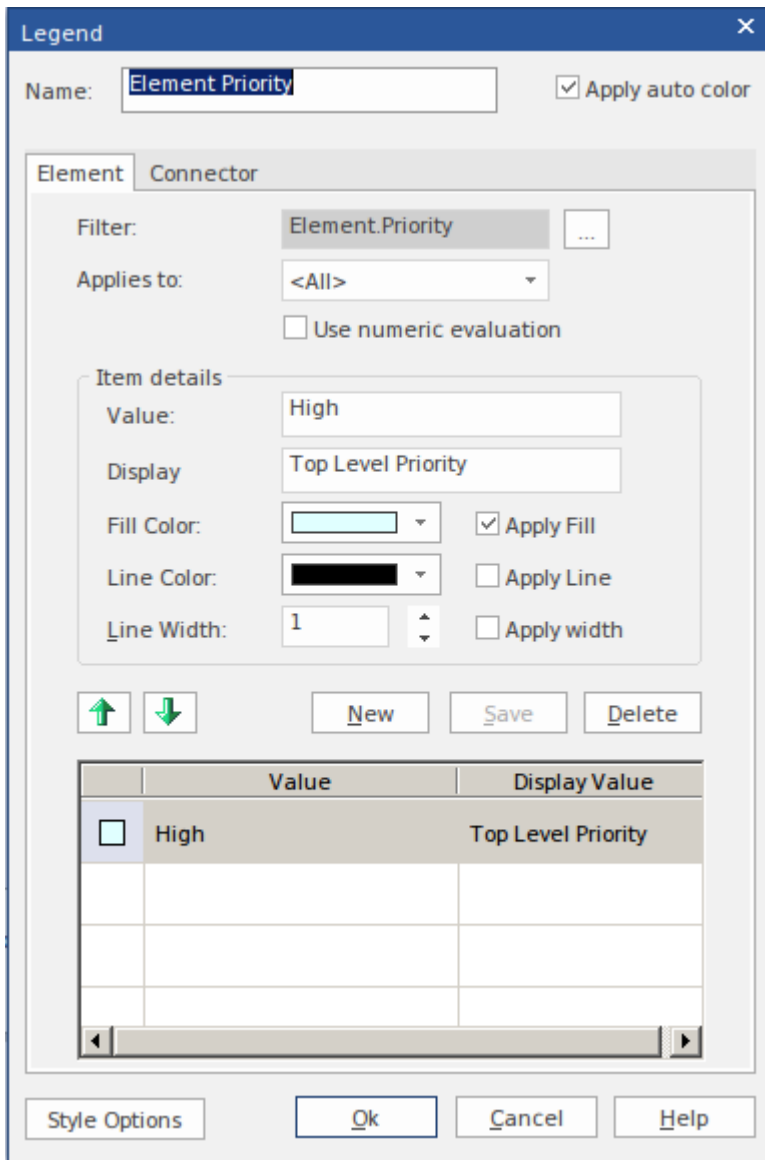

<p>Ribbon</p>	<p>Design > Element > Editors > Element > Properties Dialog Design > Element > Editors > Element > Properties > Legend</p>
<p>Context Menu</p>	<p>Right-click on Legend element Properties</p>
<p>Other</p>	<p>Double-click on the Legend element</p>

Add a Legend to a diagram

Option	Action
Name	<p>This field defaults to the name 'Legend'; overwrite or edit the name if necessary. If you are using the 'Apply auto color' facility, you might use the Legend title to state which object property you are filtering for.</p>
Apply auto color	<p>Select this checkbox if you intend to apply an appearance convention automatically, according to a property of the objects as identified in the 'Filter' field.</p>
Filter	<p>Click on the  button and, firstly, select whether the convention is to apply to an element (or connector) property or to a Tagged Value.</p> <p>For an element or connector, a list of properties displays from which you select the appropriate type.</p> <p>For a Tagged Value, select whether to use a customized tag or select a standard one.</p>

	<p>In either case, the 'Select Tagged Value' dialog displays. This dialog has a drop-down field from which you select the tag to apply the appearance convention to. The drop-down list is populated according to the options you select:</p> <ul style="list-style-type: none"> • Global Tagged Values - populates the drop-down list with all global tags in the project, including profile Tagged Values; you can therefore select a tag that is applicable to a large number of elements • Tagged Values from the selected element - click on the Select Element button and locate and select the required element; this populates the drop-down list with the Tagged Values from that element, so you can select from a specific set of tags <p>Note that the tag does not have to exist already; you can type in the name of a new tag if necessary.</p> <p>Click on the OK button to apply your selection.</p>
<p>Applies to</p>	<p>Click on the drop-down arrow and select the type of element or connector to apply the filter and, hence, appearance</p>

	<p>convention to. If you want to apply the convention to all types of element or connector, select <All>.</p>
<p>Use numeric evaluation</p>	<p>Select this checkbox if automatic application of the convention has to evaluate the numeric value of the property. For example, if a color is to be applied to elements with a Phase of 3.0, the value can be simply matched; no evaluation is necessary. If a color is to be applied to elements with a Phase value of less than 4, the Phase values have to be evaluated to see if they are less than 4 (and not equal to 4).</p> <p>The 'Apply auto color' checkbox must be selected for this checkbox to take effect.</p>
<p>Value</p>	<p>Type the actual value of the tag or property that must be satisfied for the appearance convention to be applied. You can use any of these operators with the value:</p> <ul style="list-style-type: none"> • .. (inclusive range); for example, 3..6 colors objects with the property having a value of 3, 4, 5 or 6 • < (less than); for example, <4 colors objects with the property having a value of 1, 2 or 3

	<ul style="list-style-type: none"> • > (greater than); for example, >4 colors objects with the property having a value of 5 or greater • = (equal to); for example, =5 colors objects with the property having a value of 5 and only 5 • n (single number on its own, same as equal to) • n:y:x:z (matches on any number equal to one of the values); for example, 2:4:6:8 colors objects with the property having a value of 2, 4, 6 or 8 <p>The value that you enter becomes the name of the convention item in the Legend, unless overridden by the 'Display' value.</p>
<p>Display</p>	<p>Whilst the Legend will operate on the property value you have specified, you might prefer a different text string to actually display on the Legend element to provide a clearer indication of what is being indicated. In this case, type in the text string to show on the Legend element.</p> <p>For example, the Legend will auto-color elements on the basis of high, medium or low priority, but you might want to put this into the context of the diagram and</p>

	<p>use text such as 'Daily Reporting', 'Weekly Reporting' and 'Monthly Reporting'.</p>
Fill Color	<p>Click on the down arrow and select the standard color used as the fill or background color of the elements that match the selection criteria.</p> <p>If you have manually applied a non-standard color on the diagram, it should be available from the bottom of the pallet. If not, click on the More Colors button and either select from the larger pallet or define it as a custom color.</p>
Apply Fill	<p>(Defaults to selected; disabled if 'Apply auto color' is not selected.)</p> <p>Deselect the checkbox if you do not want the fill color to be automatically applied (that is, you only want the line color and/or line width automatically applied). This setting applies to the Legend as a whole, not just to a key on the Legend.</p>
Line Color	<p>Click on the down arrow and select the standard color used for the connector line or element border.</p> <p>If you have manually applied a</p>

	<p>non-standard color on the diagram, it should be available from the bottom of the pallet. If not, click on the More Colors button and either select from the larger pallet or define it as a custom color.</p>
Apply Line	<p>(Defaults to selected; disabled if 'Apply auto color' is not selected.)</p> <p>Deselect the checkbox if you do not want the line color to be automatically applied (that is, you only want the fill color and/or line width automatically applied). This setting applies to the Legend as a whole, not just to a key on the Legend.</p>
Line Width	<p>Either:</p> <ul style="list-style-type: none"> • Overtyping the line width value with a different value (between 1 for thinnest and 5 for thickest), or • Clicking on the 'spinner' arrows to increase or decrease the thickness
Apply width	<p>(Defaults to selected; disabled if 'Apply auto color' is not selected.)</p> <p>Deselect the checkbox if you do not want the line width to be automatically applied (that is, you only want the fill color and/or line color automatically applied).</p>

	This setting applies to the Legend as a whole, not just to a key on the Legend.
New	Click on this button to clear the fields in preparation for defining a new appearance convention in the Legend. Take into account the points concerning multiple conventions and multiple Legend elements.
Save	Click on this button to save any changes you have made to an appearance convention.
Delete	Click on this button to delete the appearance convention you have selected in the current list.
Value Display Value	Shows the appearance conventions defined for objects in the diagram.
Hand (Up)	If more than one definition is listed, click on this button to move the selected item closer to the start of the list.
Hand (Down)	If more than one definition is listed, click on this button to move the selected item closer to the end of the list.

Style Options	Click on this button to define or edit the appearance of the Legend element itself.
OK	Click on this button to save any current changes and close the dialog.
Cancel	Click on this button to abort any unsaved changes you have made, and close the dialog.

Notes

- When you close the dialog, the Legend element is displayed showing all the appearance conventions defined; element conventions are listed first with connector conventions underneath, separated by a line across the Legend element

Navigation Cells

Enterprise Architect makes it easy for users to navigate through a repository by providing a handy diagram mechanism to hyperlink to any other diagram in the repository. This is the Navigation Cell, which you use to provide a simple or more ornamental direction and link to a diagram of significance to the user. You can add several Navigation Cells to a diagram to create a top-level home page, directing users to areas of the model they are interested in or responsible for. You can add Navigation Cells to a hierarchy of diagrams, further directing the user to more and more specific aspects of the model. An excellent illustration of this is the 'Getting Started' diagram of the Enterprise Architect EAExample model.

Getting Started



The diagrams containing Navigation Cells are viewable through the Internet browser and Cloud products, and provide a compelling experience for casual users and non-modelers, as well as more technical and experienced users. The navigation diagrams can be used as a Marketing tool, Customer information tool, or quick introduction to a model's composition. Navigation Cells are also the vehicle for identifying and providing access to diagrams that are to

be reviewed in a Formal Review.

Creating Navigation Cells

To create a Navigation Cell, open the diagram you are developing as the Home Page and, from the Browser window, drag a target diagram onto that Home Page. The 'Select Type' dialog displays. Select the 'Navigation Cell' radio button.

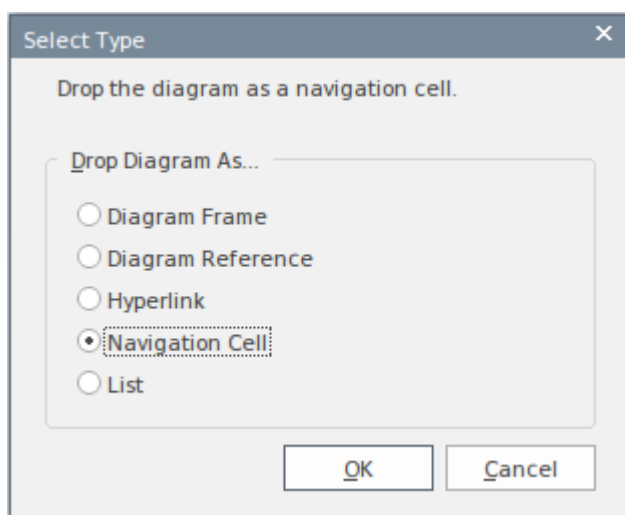

This option creates the Navigation Cell, containing the name of the target diagram and, in the top right corner, an icon representing the diagram type. Just after you click on the OK button, the 'Select Image' dialog displays, from which you can select a graphic that represents the nature of the diagram. You can also select a diagram Theme for the image, from the 'Image List' field. If you do not want to add an image to the element, click on the Cancel button.

If you are using an image, it displays in the center of the element with the target diagram name at the top, as shown in the EAExample illustration. If you are not using an image, the name displays in the center of the element.

If you subsequently decide to change or remove the image in a Navigation Cell, right-click on the element and select the 'Appearance > Select Navigation Image' option. The 'Select Image' dialog displays, and you can simply click on a different image or - to just remove the existing image - click on the Cancel button.

Selecting the 'Navigation Cell' option also enables the 'Run auto layout' checkbox, which you can select to automatically adjust the layout of the Navigation Cells to form a grid with 10 units of separation between cells. (The unit is defined in the diagram 'Properties' dialog). If you do not want to adjust the layout of the cells, clear the checkbox before clicking on the OK button.

If you use Navigation Cells in a model, they add the stereotype <<NavigationCell>> and its associated Shape Script to the model. Users opening the model in builds of Enterprise Architect earlier than 13.5 can then use this stereotype to create more Navigation Cells that are functionally the same as the Cells under Release 13.5, though a little more rudimentary.

Using Navigation Cells

When a Navigation Cell is displayed on a diagram, it provides a number of options for opening and displaying its linked diagram.

- Double-click on the Navigation Cell element in the diagram - the linked diagram opens in a separate tab in the Diagram View

- Click on the icon in the top right corner of the cell - the linked diagram is shown in a floating Diagram Pop-up window; click off the diagram to close the window
- Right-click on the Navigation Cell to display a pop-up menu, then choose either of two options: 'Open > In New Tab' or 'Open > In Current View'.

If the Navigation Cell element is selectable (right-click on the element and select the 'Behavior | Selectable' option) you can also:

- Press the = key to display the linked diagram on a separate tab in the Diagram View
- Click on the  icon off the right side of the element - the linked diagram is shown in the floating Diagram Pop-up window; click off the diagram to close the window or double-click to open the previewed diagram for editing in the main work area.

If the 'Enable Concise Diagram Navigation' checkbox is selected on the 'Application Look' (Visual Style) dialog, and you double click on the Navigation Cell or press the = key, the linked diagram replaces the parent diagram in the same tab. To return to the parent diagram (or, in a chain of diagrams, the next up in the chain) either:

- Press the Backspace key or
- Click on the arrow at the right-hand end of the diagram tab

If you have used the = key to display the linked diagram, when the parent diagram redisplay the Navigation Cell element is also selected and given focus.

Swimlanes

Swimlanes are vertical or horizontal bands in a diagram that divide the diagram into logical areas or partitions. You can apply them to all Enterprise Architect diagram types.

Activities relating to particular entities within the model (such as the User, or the back end Repository) can be placed within the same Swimlane to indicate their association. You set up the Swimlanes for a diagram using the 'Swimlanes and Matrix' dialog .

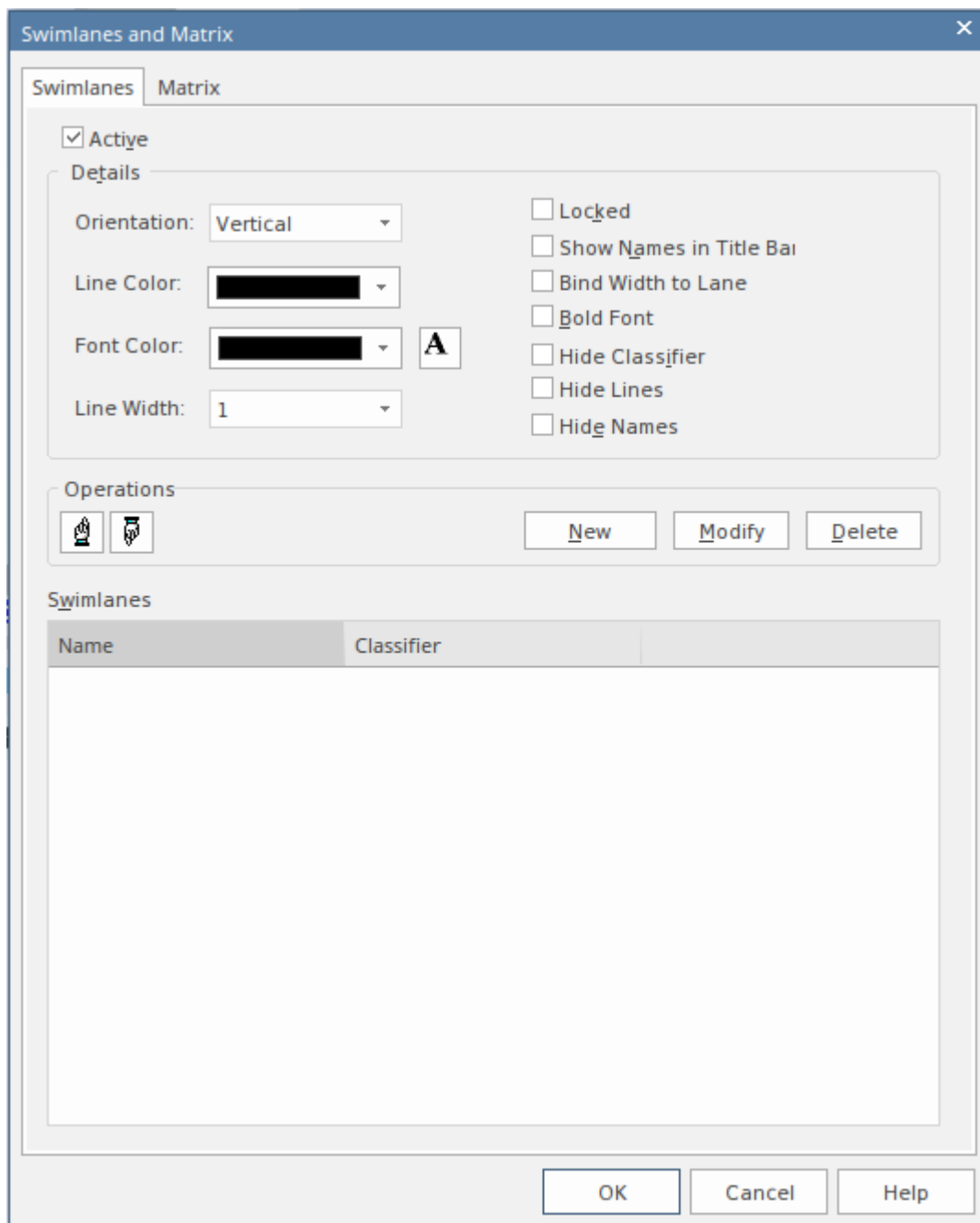

Having created a Swimlane, you can divide it into sub-lanes using context menu options.

Access

Ribbon	Design > Diagram > Manage >
--------	-----------------------------

	Swimlanes > Swimlanes Layout > Diagram > Swimlanes > Swimlanes
Context Menu	Right-click on diagram background Swimlanes and Matrix > Swimlanes

Options

Option	Action
Active	Select this checkbox to make the Swimlane facilities active on the diagram, as opposed to the Matrix facilities.
New	Click on this button to begin defining a new Swimlane for the diagram. The 'Swimlane Details' dialog displays, on which you provide the name, classifier and background color of the Swimlane.
Orientation	Click on the drop-down arrow and select the orientation of the Swimlanes: Vertical or Horizontal.
Line Color	Click on the drop-down arrow and select

	<p>the color in which to display all Swimlane borders.</p> <p>If the color you require is not shown, click on the More Colors button and either select from a wider range of standard colors or define a custom color.</p>
Font Color	<p>Click on the drop-down arrow and select the color in which to display all Swimlane text.</p> <p>If the color you require is not shown, click on the More Colors button and either select from a wider range of standard colors or define a custom color.</p>
A	<p>Click on this button to display the 'Font' dialog, on which you can define the type, style, size and effects of the font used for text on all Swimlanes in the diagram.</p> <p>If you also change the text color here, it overrides the setting of the 'Font Color' field.</p>
Line Width	<p>Click on the drop-down arrow and select the line width of all Swimlane borders - either 1 (thinnest), 2 or 3 (thickest).</p>
Locked	<p>Select this checkbox to prevent the Swimlanes in the diagram from being</p>

	made narrower or wider.
Show Names in Title Bar	(If the 'Orientation' field is set to 'Vertical'.) Select this checkbox to display each Swimlane name in the title bar, above the Swimlane.
Bind Width to Lane	Select this checkbox to bind the width of the elements in the diagram to the width of the swimlane or sub-lane holding them, so that if you change the width of any lane you do not have to manually adjust the width of each element it contains. If non-rectangular elements (such as Use Cases) are not bound to the lane width, make sure that the 'Allow elongated Use Cases' option is selected on the 'Preferences' dialog 'Objects' page.
Bold Font	Select this checkbox to display all Swimlane text in bold.
Hide Classifier	Select this checkbox to block all Swimlane classifier names from being shown on the diagram.
Hide Lines	If the 'Bind Width to Lane' checkbox is selected, you can select this checkbox to hide the body of each swimlane (and, if

	<p>the Swimlane has them, sub-lane), so that only the header cell is shown on the diagram. The element width and lane width remain bound</p>
Hide Names	<p>Select this checkbox to block all Swimlanes names from being displayed on the diagram.</p>
Swimlanes	<p>This panel lists the currently defined Swimlanes, in the sequence (top to bottom) in which they are displayed on the diagram (left to right, or top to bottom).</p> <p>To create sub-lanes within a Swimlane, right-click on the Swimlane name and select the 'Create sub lane' option. You can also copy sub-lanes from another Swimlane and paste them into the current Swimlane.</p> <p>The context menu also provides options to:</p> <ul style="list-style-type: none">• Edit the Swimlane properties - displays the 'Swimlane Details' dialog, on which you can change the Swimlane name, Classifier and fill color• Delete the Swimlane - prompts you to confirm deletion of the Swimlane before removing it from the list

Modify	Click on this button to change the name, classifier or background color of a selected Swimlane. The 'Swimlane Details' dialog displays.
Hand (Up)	Click on this button to move a selected Swimlane one position up in the Swimlanes list.
Hand (Down)	Click on this button to move a selected Swimlane one position down in the Swimlanes list.
Delete	Click on this button to delete a selected Swimlane from the Swimlanes list and from the diagram. A prompt displays for you to confirm the deletion.

Notes

- All changes you make on or through the 'Swimlanes and Matrix' dialog must be saved by clicking on the [OK button](#) in order to render those changes on the diagram
- If you set a background color for a Swimlane, it takes on the same shading profile as the main diagram background
- You can adjust the width or height of a Swimlane by

dragging the border, whilst sub-lanes are automatically adjusted to take up the appropriate fraction of the Swimlane; for example, two sub-lanes take up half of the Swimlane each, three take up a third of the Swimlane each, and so on

Creating Sub-lanes

When you add elements to a diagram, you can position them in horizontal or vertical Swimlanes to indicate the presence or absence of a particular feature or property.

Within each Swimlane you can further group or separate the elements into sub-lanes, which are a useful device for defining another level in the organization of the diagram. For example, you might want to divide a 'Process' lane into two sub-lanes representing input and output, or 'In-Progress' and 'Complete'. The 'Sub-lanes' page helps you to quickly and easily create any number of new sub-lanes for a Swimlane on a diagram.

Access

Ribbon	<p>Design > Diagram > Manage > Swimlanes > Swimlanes > Right-click on a Swimlane</p> <p>Layout > Diagram > Swimlanes > Swimlanes > Right-click on a Swimlane</p>
Context Menu	<p>Right-click on diagram background Swimlanes and Matrix > Swimlanes > Right-click on a Swimlane</p>

Swimlane Context Menu Options

Right-click on the name of a Swimlane in the 'Swimlanes' panel.

Create sub lane	Displays the 'Create sub lane' dialog, on which you enter the title of the sub-lane. Click on the OK button to save the name and add it to the 'Swimlanes' panel.
Copy sub lanes	Copies all the sub-lanes underneath the selected Swimlane.
Paste lane(s)	Adds the sub-lanes held in the clipboard to the currently-selected Swimlane.

Sub-lane Context Menu Options

Right-click on the name of a sub-lane in the 'Swimlanes' panel.

Edit name	Displays the 'Edit sub lane name' dialog, on which you overtype the existing name with a new name. Click on the OK button to effect the change and close the dialog.

	The Modify button on the 'Swimlanes' tab has the same effect.
Delete lane	Removes the sub-lane from the list. There is no confirmatory prompt. The Delete button on the 'Swimlanes' tab has the same effect.
Copy Lane	Copies the sub-lane to the clipboard. Use the 'Paste lane(s)' option on the Swimlane context menu to add the copied lane to another Swimlane

Notes

- If you want to re-organize the sub-lanes, click on a sub-lane name and use the 'Hand Up' and 'Hand Down' buttons, as for the Swimlanes
- Whilst you can adjust the width or height of a Swimlane by dragging the border, sub-lanes are automatically adjusted to take up the appropriate fraction of the Swimlane; for example, two sub-lanes take up half of the Swimlane each, three take up a third of the Swimlane each, and so on

Swimlane Details

To define a vertical or horizontal Swimlane on a diagram, you use the 'Swimlane Details' dialog.

Access

Ribbon	Design > Diagram > Manage > Swimlanes > Swimlanes : New or Modify Layout > Diagram > Swimlanes > Swimlanes : New or Modify
Context Menu	Right-click on diagram background Swimlanes and Matrix > Swimlanes : New or Modify

Options

Options	Action
Name	Type a name for the Swimlane.
Classifier	(Optional) Click on the  button to browse for and select a classifier for the Swimlane.

	<p>To delete a previously-assigned classifier, click on the  button and select the '<none>' option.</p>
Back Color	<p>Click on the drop-down arrow and select the color in which to display the Swimlane background.</p> <p>If the color you require is not shown, click on the More Colors button and either select from a wider range of standard colors or define a custom color.</p>
OK	<p>Click on this button to save and apply your changes, and close the dialog.</p>
Cancel	<p>Click on this button to abort your changes, and close the dialog.</p>

Swimlanes Matrix

On any type of Enterprise Architect diagram, you can develop a Swimlanes Matrix to divide your diagram into cells at the intersections of columns and rows. This Matrix is based on the Zachman Framework. The top left cell of the Matrix contains the heading text, the cell at the top of each column contains the column title text and the cell at the left of each row contains the row title text.

You can define only one Matrix Heading cell, but you can create as many row and column headings as you need. You can also leave the column width and row height adjustable on the diagram, or fix the positions so that the cell borders cannot be moved.

The Matrix is defined on the 'Swimlanes and Matrix' dialog.

Access

Ribbon	Design > Diagram > Manage > Swimlanes > Matrix Layout > Diagram > Swimlanes > Matrix
Context Menu	Right-click on diagram background Swimlanes and Matrix > Matrix

Options

Option	Action
Active	Click on this checkbox to set the diagram to use the defined Matrix facilities, as opposed to any Swimlanes that have also been defined.
New	Click on this button to clear the dialog fields so that you can add a new column or row item to the Matrix.
Title #	<p>Type in a title name. You can provide one, two or three title names per heading to, for example, group a set of columns or rows.</p> <p>There is no effective limit on the length of the text string but it does not wrap, so to display the full text you might have to drag the cell borders out to create a wide cell. Alternatively, you can divide the text string between the 'Title' fields to reduce the overall cell width.</p>
Color	Click on the drop-down arrow and select the color in which to display the text in the heading, row or column title.

	<p>If the color you require is not shown, click on the More Colors button and either select from a wider range of standard colors or define a custom color.</p>
Font	<p>Click on this button to display the 'Font' dialog, through which you define the font and style, size and effects of the text in the Matrix header, column and row titles. If you also change the text color here, it overrides the setting of the 'Color' field.</p>
Hidden	<p>Select this checkbox to hide the corresponding Matrix header, row or column Title text on the diagram.</p>
Type	<p>Click on the drop-down arrow and select 'Heading', 'Column' or 'Row' to apply your field settings to the Matrix heading cell, a column heading or a row title, respectively.</p>
Back Color	<p>Click on the drop-down arrow and select the color in which to display the heading cell, row or column background.</p> <p>If the color you require is not shown, click on the More Colors button and either select from a wider range of standard colors or define a custom color.</p>

Hide Item	Select this checkbox to hide the Matrix heading cell, row or column on the diagram.
Model Profiles	<p>Click on the drop-down arrow and select:</p> <ul style="list-style-type: none"> • An existing Profile to override the current contents of the dialog • 'Empty Profile' to clear the fields so that you can define a matrix to save as a new Profile (see <i>Model Profiles: Save</i>)
Model Profiles: Save	<p>Click on this button to save the current dialog contents as a new Profile. A prompt displays for you to assign a name to the Profile.</p>
Model Profiles: Delete	Click on this button to delete the currently-displayed user-defined Matrix Profile from the drop-down list.
Line Widths	Click on the drop-down arrow and select the line width of all row and column borders - either 1 (thinnest), 2 or 3 (thickest).
Line Color	Click on the drop-down arrow and select the color in which to display all lines in

	the matrix.
Lock	Select this checkbox to prevent the Matrix rows and columns in the diagram from being resized.
Matrix list	<p>Lists the components of the current Matrix Profile, starting with the Heading and followed by the columns and then the rows. For each item, the list shows the first title (Title 1) whether it is visible on the diagram, and what type it is.</p> <p>The columns are listed in the order in which they are displayed, left to right, on the diagram.</p> <p>The rows are listed in the order in which they are displayed, top to bottom, on the diagram.</p>
Hand (Up)	<p>Click on this button to move a selected column or row one position up in the Matrix list. You cannot move a Column item above the Heading item, or a Row item above a Column item.</p> <p>When you save the changes, on the diagram the selected column or row is moved left or up one place.</p>
Hand (Down)	Click on this button to move a selected

	<p>column or row one position down in the Matrix list. You cannot move the Heading item below a Column item, or a Column item below a Row item.</p> <p>When you save the changes, on the diagram the selected column or row is moved right or down one place.</p>
Save	<p>Click on this button to save the contents of the dialog, but not close the dialog, so that you can define or edit columns and rows individually and save them before defining the next item.</p>
Copy	<p>Click on this button to copy a selected item from the list so that you can give it a new Title 1 and edit it as a new item.</p> <p>If you change the item, it is added to the list when you click on the Save button.</p>
Delete	<p>Click on this button to delete a selected item from the list. The column or row is removed from the list and diagram, which both close up.</p>
OK	<p>Click on this button to save and apply your changes, and close the dialog.</p>
Cancel	<p>Click on this button to abort your</p>

	changes, and close the dialog.
--	--------------------------------

Notes

- When you define columns and rows, you define the header or title cells; the properties of these cells do not reflect on the matrix cells themselves - for example, the intersection cell of a column and row has a transparent background and therefore takes the color and shading effect of the diagram background
- You can transport the Swimlanes Matrix Profiles between models (as Diagram Matrix Profiles), using the 'Settings > Model > Transfer > Export Reference Data' and 'Import Reference Data' ribbon options
- By applying a Matrix Profile to a diagram, you replace the current profile; save the current profile to avoid losing it
- To size the rows and columns, drag the row and column borders on the diagram - elements placed inside each cell are shifted when sizing; to prevent the elements shifting, press and hold Ctrl while sizing

Diagram Relation Matrix

The Diagram Relation Matrix View presents the contents of the current diagram in the form of a simple grid, identifying the relationships between the named elements on that diagram. Objects that have an empty name field are not included in the matrix.

Access

Ribbon	Design > Diagram > Views > Relation Matrix View
Context Menu	Right-click on diagram background Switch View Switch to Relation Matrix View or Right-click on diagram tab Switch to Relation Matrix View In the Browser window, right-click on the name of the open diagram Switch View Switch to Relation Matrix View

The Relation Matrix View

The Relation Matrix view is similar to the project-level Relationship Matrix, but it is a diagram view and as such

displays only those elements contained in the selected diagram and has fewer fields to define where those relationships are detected.

Each row and each column of the Relation Matrix view represents a diagram element. There is small italic number on the top-left corner of each row and column cell, which is the row/column index. The cell at the intersection of a row and a column shows the details of any relationships between the corresponding diagram elements.

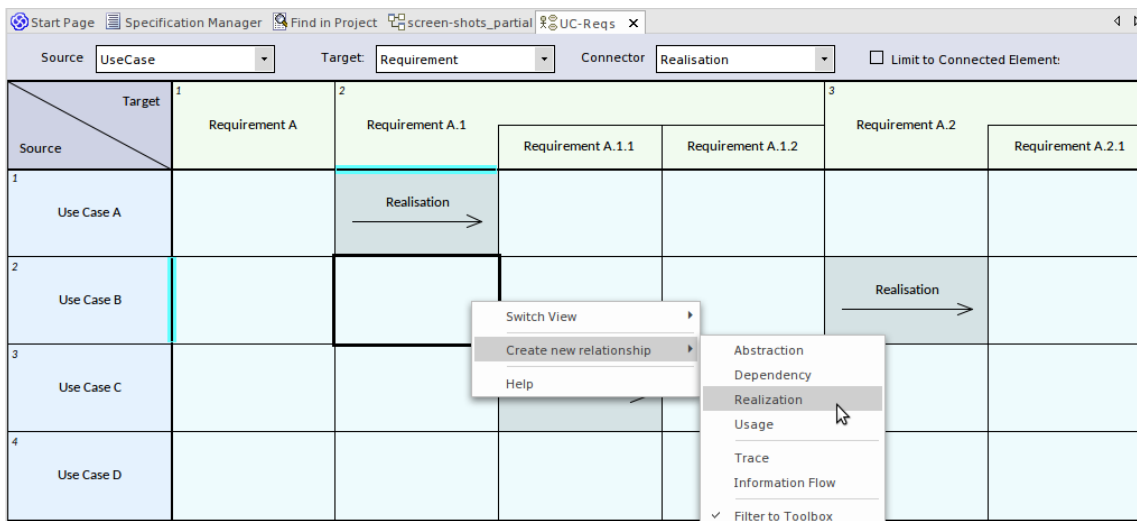

The Relation Matrix view provides a means to quickly identify elements that are not yet connected to other elements, such as Requirements elements that are not yet realized. You can also create new relationships or delete existing relationships directly in the matrix.

Selecting a cell in the matrix shows additional relationship properties where they exist, such as cardinality values and roles. Where relationships exist between features of the source and target elements, this is represented on the matrix as well.

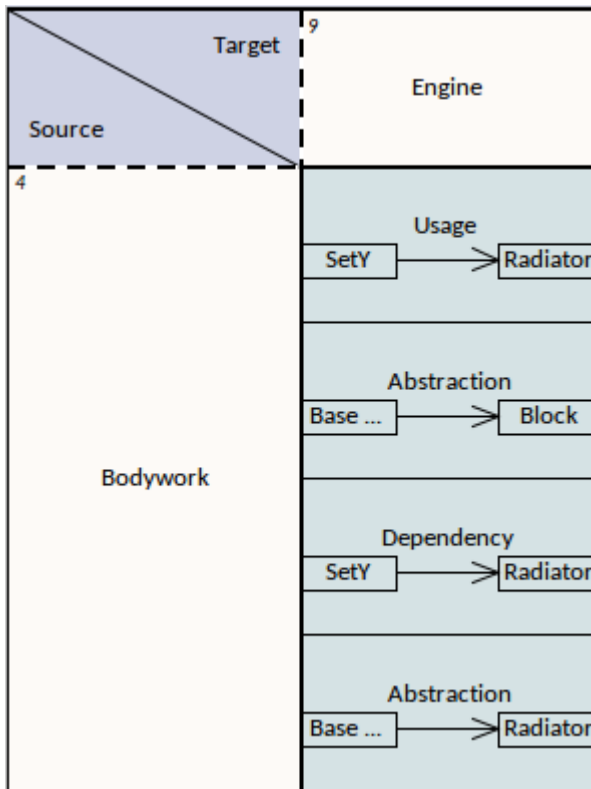

Viewing Options

You can refine the display to show only:

- Relationship connectors of a specific type
- Source elements of a specific type and/or
- Target elements of a specific type

Click on the drop-down arrow for the appropriate field at the top of the matrix, and select the required type. Note that the element and connector types in the lists are only for those objects that are already in the diagram.

You can further restrict the display to show only elements that already have connectors, by selecting the 'Limit to Connected Elements' checkbox.

Format

By default, the Relation Matrix View displays elements in a hierarchy, as for Requirement A1 in the earlier example. You can change this to display the elements in flat lists by right-clicking in the top left cell and deselecting the 'Show Element Hierarchy' option.

Navigate the Relation Matrix

You can navigate through the Relation Matrix using either the scroll bars or the arrow keys.

Scroll Bars:

- If the matrix is bigger than the display area of the screen, and some of the element/relation cells cannot be seen, a vertical and/or a horizontal scroll bar is displayed so that you can scroll to the hidden area of the matrix
- If you scroll the matrix up, the column headers remain visible whilst the rows appear to roll beneath them and are hidden; in this case, the top edge of the first visible row header becomes a dashed line to indicate there are hidden rows above it (and you will notice that the italic number in the top left corner of the cell will be a number greater than 1)
- Similarly, if you scroll the matrix left, the row headers remain visible while the columns appear to roll beneath them and are hidden; the left edge of the first visible column header becomes a dashed line to indicate there are

hidden columns to the left of it (and the italic number in the top left corner of the cell will be a number greater than 1)

Target	2 Actor A	3 Acto
Source		
4 Requirement A		
5 Requirement A.1		

Arrow Keys:

- From a selected cell of the matrix, you can press the arrow keys to move to a neighboring cell of the same type (that is, column header to column header, row header to row header or grid cell to grid cell)
- To move between cells of different types, such as from a grid cell to a column header cell or vice versa, press Ctrl as you press the arrow keys
- If the neighboring cell is hidden or outside the display area, pressing the appropriate arrow key will scroll the Relation Matrix to show the row or column containing that cell

Add / Delete Element

You can add elements to the Relation Matrix by:

- Dragging the appropriate element icon from the Toolbox onto the 'Target' triangle or 'Source' triangle (to add a peer

element) or onto an element in the Target row or Source column (to add the new element as a child of the selected element)

- Dragging an element from the Browser window on to the Target row or Source column
- Right-clicking on an element name in the Target row or Source column, and selecting the 'New Child Element' option to add a new child element of a type listed in the submenu
- Right-clicking on an element name in the Target row or Source column, and selecting the 'Insert Related Elements...' option to insert a related element of the selected element, using the Insert Related Elements dialog
- Right-clicking on the diagram background outside the Relation Matrix and choosing the 'Insert Other Element...' option to insert an element from any Package, located and selected using the 'Select Element' browser

You can delete an element from Relation Matrix by selecting the element-name cell and either:

- Pressing Ctrl+Delete, which deletes the element and its connectors from the model; you are prompted to confirm the deletion, or
- Right-clicking on the cell and selecting the 'Delete <element name>' option (the element is immediately removed from the matrix and diagram), or
- Pressing the Delete key

Add / Delete Connector

The Diagram Relation Matrix greatly simplifies the process of creating and removing relationship connectors between elements.

To **add a connector**, click on the cell at the intersection of the source element row and target element column and:

- Right-click and select the 'Create new relationship' option, and then select the type of connector from the sub-menu, or
- If there is currently no connector between the source and target element, press the Spacebar and then select the type of connector from the submenu, or
- If there is a connector and you want to add another one, press the Spacebar, select the 'Create new relationship' option and then select the type of connector from the submenu

To **delete a connector**:

Click on the cell containing the connector to delete, and either:

- Press Ctrl+Delete, which prompts you to confirm the action before deleting the connector from model, or
- Right-click and select the 'Delete Connector' option, which prompts you to specify whether to simply hide the connector or to delete the connector from the model, or
- Press the Delete Key, which again prompts you to select between hiding and deleting the connector

Display Element / Connector Properties

You can display the properties of any element or a connector in the matrix, either in the object's 'Properties' dialog or in the docked Properties window.

- To display the 'Properties' dialog, double-click on the name of the element or connector in a cell
- To display the docked Properties window, click on the name of the element or connector in a cell and press Ctrl+Enter; if the window is already displayed, simply click on the element or connector name to make it the focus of the window

Certain features are shown on the cell itself. For example, the cell for an Information Flow on a SysML diagram also shows the conveyed items. You can locate the conveyed items in the Browser window by right-clicking on the name and selecting the 'Find Conveyed Items' option.

In-Place Editing Element Names

If you should need to correct the name of an element in the Relation Matrix, you can easily do so using the in-place editor; click on the element cell and either press F2 or click on the element name twice (not double click). Type in the correct text and press the Enter key.

Hide/Show Relationships

If you want to simplify your diagram and its various representations, you can hide connectors that are not immediately relevant to the view, and recall them when your purpose requires them. Hiding or showing a connector in one view of the diagram affects all the other views.

Before attempting to hide connectors, make sure the 'Prompt on connector deletes' checkbox is selected in the 'Links' page of the 'Preferences' dialog ('Start > Appearance > Preferences > Preferences > Links').

To hide a connector:

Click on the cell showing the connector you want to hide, then either:

- Right-click and select the 'Visibility | Hide Connector' option, or
- Right-click and select the 'Delete Connector' option, then on the 'Remove Connector' dialog select the 'Hide the connector' radio button and click on the OK button, or
- Press the Delete key, and again on the 'Remove Connector' dialog select the 'Hide the connector' radio button and click on the OK button,

To show a hidden connector:

Click on the cell containing the connector you want to reveal, then:

- Right-click and, if the cell does contain any hidden connectors, click on the option 'Show Relation' (the option is not provided if there are no hidden connectors)
- From the sub-menu listing all the hidden connectors by type and (if set) name, select the connector to show

Navigate between Graphical view and Relation Matrix view

You can easily switch from the Relation Matrix View to the graphical representation or any of the other diagram views, using the right-click context menu option 'Switch View | Switch to Graphical View' (or 'Switch to <other> View').

If you select the option after clicking on a:

- General area of the matrix, the diagram displays from the top left corner, and other views display from the starting point
- Relation cell that shows a specific connector, the diagram or other view displays with that connector or its information visible and selected

If you are in the diagram in its graphical view, you can select a connector and specifically focus on it in the Diagram Relation Matrix, by right-clicking on the selected connector and clicking on the 'Switch to Relation Matrix View' option. The matrix displays with the cell for that connector in the center of the display.

Publish the Relation Matrix

When you render the diagram as a Relation Matrix, you can capture the appearance of the matrix in a:

- Printed hard copy - 'Publish > Diagram Image > Print > Print'

- PDF file - 'Publish > Diagram Image > Print > Print to PDF
- Image file - 'Publish > Diagram Image > Save > Save to File
- Clipboard capture - 'Publish > Diagram Image > Save > Save to Clipboard

Roadmap Diagrams

Roadmap diagrams help you to map existing elements against a timeline. This is useful for visualizing how a system changes over time, planning a migration of responsibility between two teams, documenting the concurrent support for multiple platforms or representing just about any time based data. To ensure the modeler and viewer always have appropriate context, the timeline is always displayed on screen, on any saved images and when printed.

Changes of phase or state of each element can be represented in Roadmap diagrams using a dedicated notation of a bar divided into colored segments representing each state. The states available, the order they appear in and the colors used are controlled by a Diagram Legend. Each element displayed then shows the length of each segment (and hence duration of each state), and also provides the ability to hide individual segments on that element.

Creating a Roadmap Diagram

This diagram shows an example Roadmap that documents the planned lifecycle for two products through development, release, support and retirement, by quarter over a period of one and a half years.

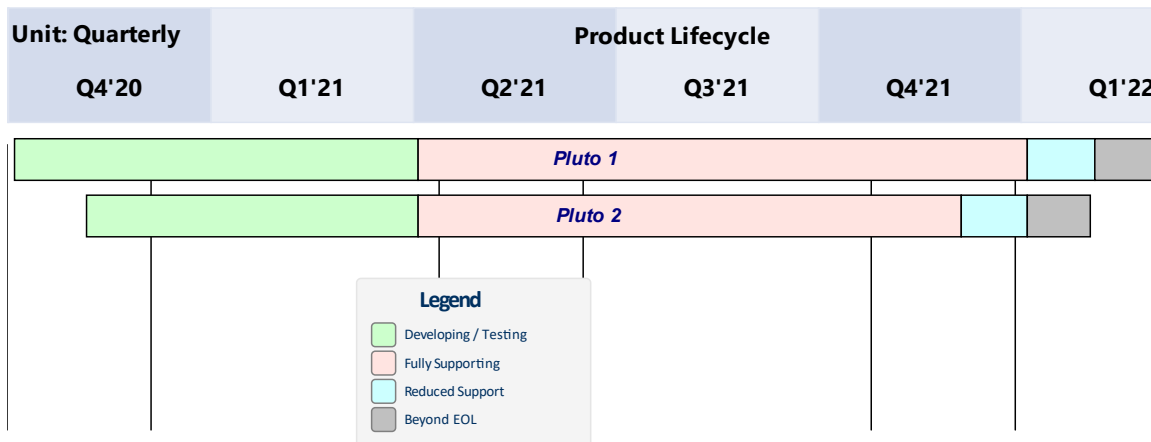

You can develop this diagram as the example for the guided procedure in the *Setting up a Roadmap Diagram* table. To create the initial, basic diagram:

1. Right-click on its parent Package and select the 'New Diagram' option. The 'Model Builder' diagram opens, with the 'Diagram Builder' tab page displayed.
2. In the 'Diagram' field, type in the diagram name, such as 'Example Roadmap'.
3. Click on the drop-down arrow in the 'Type' header and select the 'Construction > Project Management' Perspective group, and then click on 'Project Management' in the panel beneath the header.
4. The 'Diagram Types' panel lists the diagram types - Project Management, Roadmap and Backlog. Click on the Roadmap diagram type.
5. Click on the OK button. The system opens the diagram in the central work area.

You can also generate one of the pre-designed Roadmap diagrams from the Patterns provided by Enterprise Architect, to tailor the Roadmap for any of a range of areas of work. To access these Patterns, select the ribbon option

'Design > Package > Model Builder', then on the Model Builder dialog, select the 'Construction > Project Management' Perspective. If necessary, expand the 'Roadmaps' group.

Select the required Roadmap(s) and click on the Create Model button. Each Roadmap is automatically created within its own Package.

Access

To begin setting up the diagram you have just generated, on the open diagram display the 'Roadmap Options' dialog using one of the methods described here.

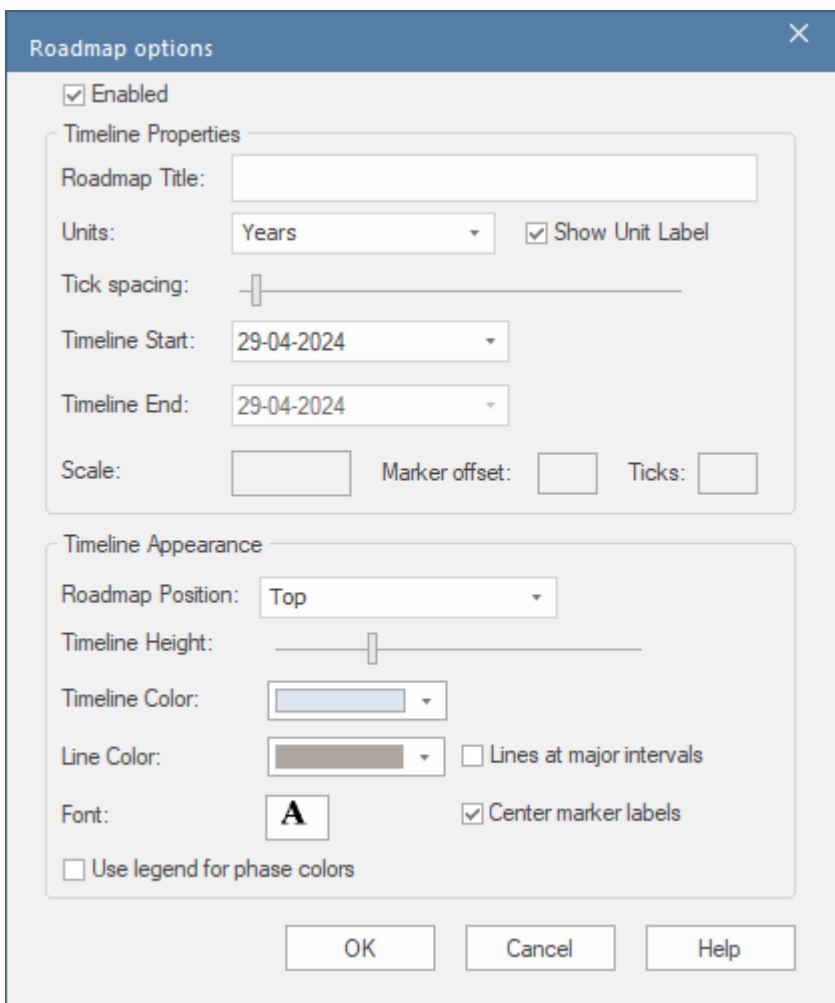

Ribbon	Design > Diagram > Manage > Roadmap
Context Menu	In the diagram, right-click on the background Roadmap

Setting up a Roadmap Diagram

Starting with the 'Roadmap options' dialog, follow these steps to set up the Roadmap diagram. The fields are described in greater detail in the *Roadmap Diagram Options* topic. This procedure includes using a Diagram Legend to automatically divide an element into phase segments in different colors. The steps lead you to create the diagram shown at the start of this topic.

Step	Action
1	Select the 'Enabled' checkbox, to enable the timeline on the diagram.
2	In the 'Roadmap Title' field, type a title for the diagram such as 'Product Lifecycle'. (The title is optional, and you can leave the field blank if you prefer.)
3	In the 'Units' field, click on the drop-down arrow and select 'Quarterly'. The major sections are displayed

	<p>in alternating light/dark shades to make it easy to distinguish between adjacent sections.</p> <p>The 'Units' field offers a wide range of pre-defined units for the scale of the Timeline, and you can define your own customized units. You can also change the section display color using the 'Timeline color' field in the 'Timeline Appearance' panel.</p>
4	<p>Click on the 'Tick Spacing' slider and drag it left or right to scale the timeline to a size that is appropriate for your diagram.</p>
5	<p>In the 'Timeline Start' field, click on the drop-down arrow and click on the date on which the Roadmap Timeline is to start. (For the example, select October 10th 2020; the exact value doesn't matter, as long as it is within the quarter you want to start in.)</p> <p>The 'Timeline End' field is disabled for date unit scales (that is, years, quarterly, months and days).</p>
6	<p>Adjust the appearance settings:</p> <ul style="list-style-type: none">• In the 'Roadmap Position' field, select the 'Top' option to position the roadmap timeline headers at the top of the diagram• Drag the 'Timeline Height' slider about half way across the bar• In the 'Line Color' field click on the drop-down arrow and select a dark color such as charcoal

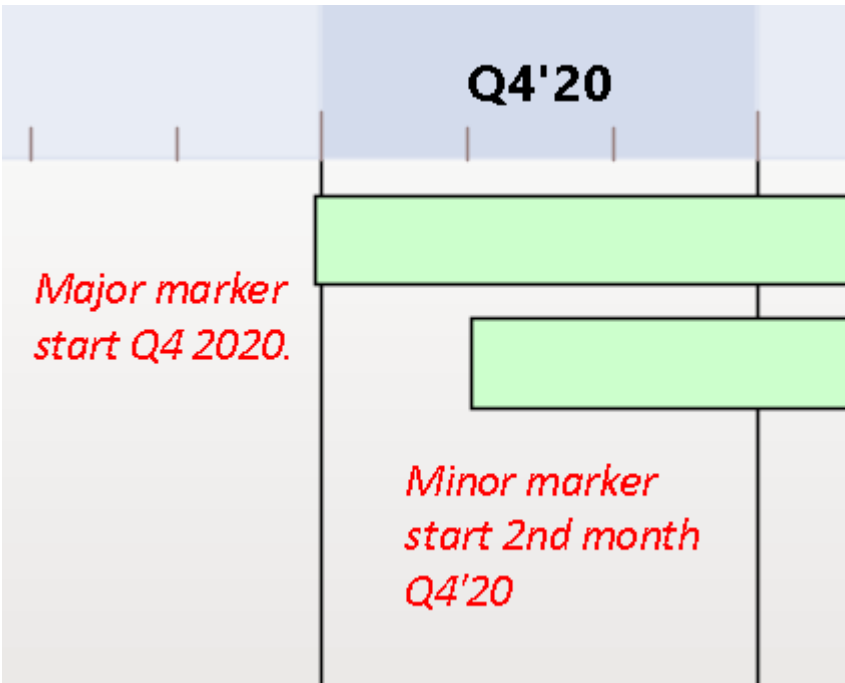
	<ul style="list-style-type: none"> • Select the 'Lines at major intervals' checkbox • Select the 'Use legend for phase colors' checkbox
7	<p>Click on the OK button to save the settings and close the dialog.</p>
8	<p>In the Diagram Toolbox, switch to the Class pages and drag two Class elements onto the diagram. Give them the names 'Pluto 1' and 'Pluto 2'.</p> <p>Move and resize 'Pluto 1' so that its left edge is on the Q4'20 major marker line (the start of October 2020), and its right edge is just under the second Q1'22 minor marker (the end of February 2022).</p> <p>Move and resize 'Pluto 2' so that its left edge is under the first Q4'20 minor marker (November 2020) and its right edge is under the first Q1'22 minor marker (the end of January 2022).</p>  <p>(Note: The diagram has been annotated to show the</p>

element positions; this text is not generated on the actual diagram.)

9 (This step is a 'placeholder' to show where in the process you add a Diagram Legend and roughly what you do. The actual procedures are in the linked Help topics in the 'See also' column.)

From the 'Common' page of the Diagram Toolbox, drag a 'Diagram Legend' icon onto the diagram.

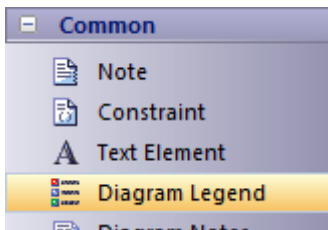

You will use this to add and format the phase segments on the two elements.

Double-click on the Diagram Legend to display its 'Properties' dialog, and define how the Legend element itself will be displayed and how the phase segments will be applied. In the example, you will define these four phases:

- Developing/Testing
- Fully Supporting
- Reduced Support
- Beyond EOL

For each phase, type the name in the 'Value' field, select a display color in the 'Fill color' field and click on the Save button to save the phase definition.

Select the 'Apply auto color' and 'Apply Fill'

	checkboxes, and then click on the OK button to save the settings and close the dialog.
10	<p>You now have two elements on the Timeline, each with four colored segments of equal length that represent the product lifecycle phases as indicated in the Diagram Legend.</p> <p>To set the duration of each phase, click on the dividing line between two phases and drag it to the appropriate point relative to the scale on the Timeline.</p> <p>You have now created a Roadmap diagram resembling the example shown at the start of this topic.</p>

Hide and Show Segments

When you set up a Legend to apply segments to the elements on a Roadmap, every element on the Roadmap has all the defined segments. However, certain segments might not be relevant to particular elements, in which case you can hide those segments on those elements. Should a hidden segment be relevant to an element, you can show it.

A new element added to the diagram will show all the segments. However, if you add a new segment to an existing element, that segment is automatically hidden and - if it is to be displayed - should be set as described here.

To hide or redisplay segments on an element:

1. Right-click on the element and select the 'Hide/Show Roadmap Segments' option. The 'Hide/Show Roadmap Segments' dialog displays, listing the segments defined in the Legend. Each segment has a checkbox.

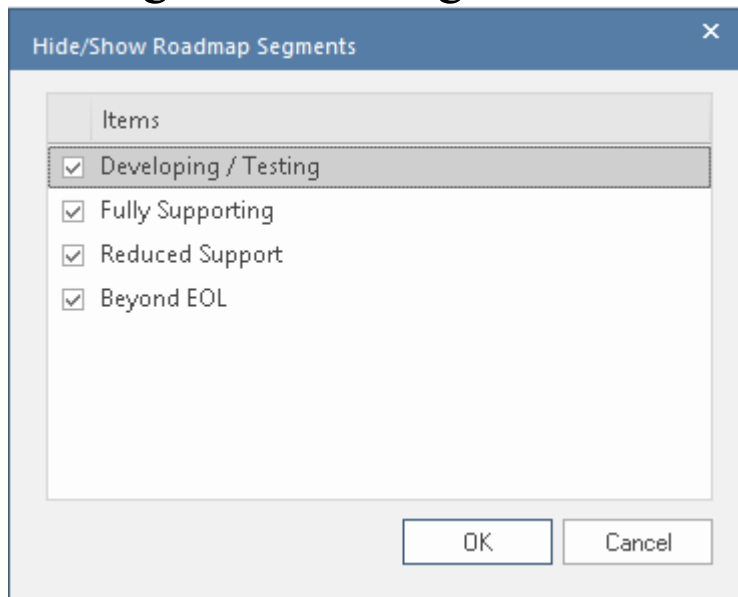

2. For each segment to show on the element, select the checkbox. For each segment to hide on the element, deselect the checkbox.
3. Click on the OK button. The selected segments on the element display on the diagram.

When a segment is hidden, the most directly-affected visible segment automatically occupies the space of the hidden segment. This is generally the segment immediately to the right (the chronologically later segment) except where the final segment in the element is hidden, when the segment to the left extends to fill the space. The overall length of the element does not change, and neither do the lengths of the remaining segments in the element; if they do need to be adjusted, drag the separator lines to the appropriate time

line.

When a hidden segment is made visible, it occupies the first time unit of the next segment in the chronological sequence (or, if it has been added to the end of the element, the final time unit of the previous segment). Again, the total length of the element is not affected, not are the lengths of the other segments in the element. You can make manual adjustments to set the length of the new segment and any other segments that need to be adjusted to accommodate it.

Notes

- The Timeline and the text displayed on it are always shown, as you scroll the diagram up or down
- You can apply further grouping or categorization of the elements on the Roadmap, by defining horizontal Swimlanes for the diagram

Roadmap Diagram Options

This topic describes each of the options available on the 'Roadmap options' dialog, which you use to define a Roadmap Timeline on a diagram. The process of creating a Roadmap diagram is described in the *Roadmap Diagrams* topic.

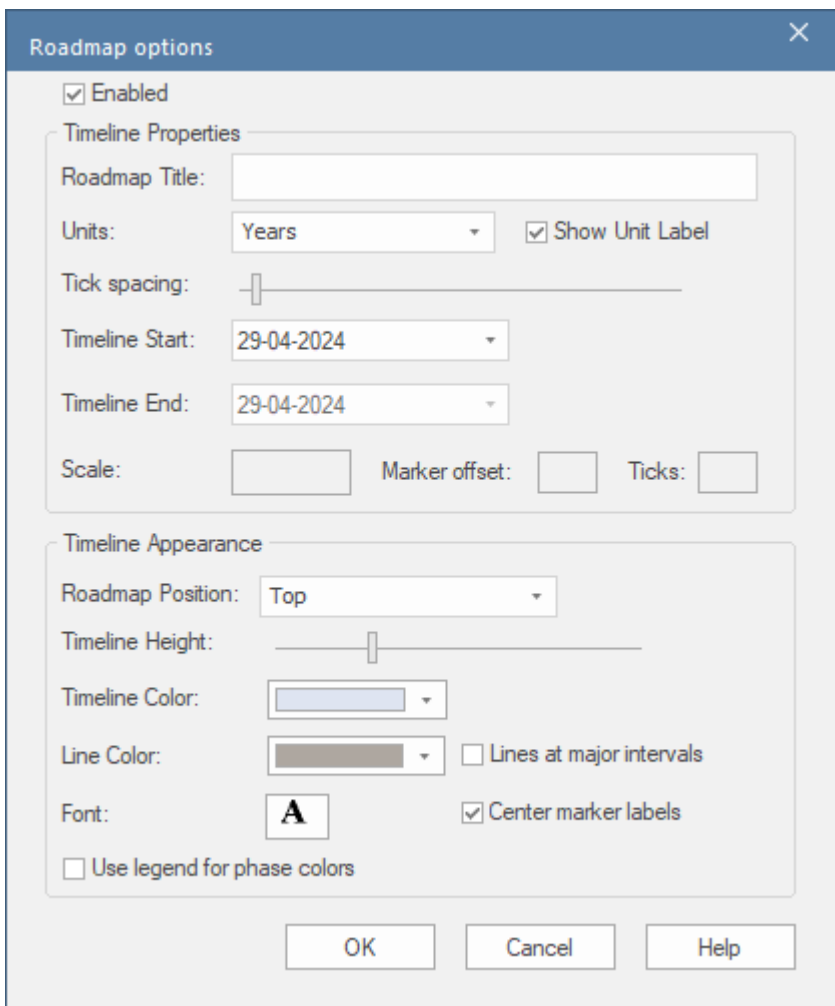

Roadmap Options

Option	Description

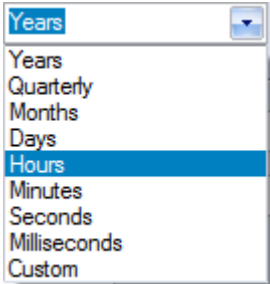
<p>Enabled</p>	<p>Select this checkbox to show the Roadmap Timeline and associated features on the diagram. Clear the checkbox to hide the Roadmap on the diagram (which will hide Roadmap features derived from a Legend, but not element features applied by a Legend independent of the Roadmap).</p>
<p>Roadmap Title</p>	<p>Type in an appropriate name or title for the Roadmap, or leave blank if no title is required.</p>
<p>Units</p>	<p>Click on the drop-down arrow and select the appropriate unit of time for the Timeline.</p>  <p>You can also select 'Custom' and define your own scale of measurement; see <i>Setting up a Custom Scale</i> at the end of this topic.</p> <p>The selected unit is automatically identified in the top left corner of the Timeline, and the appropriate sequence of units displays along the width of the</p>

	<p>Timeline.</p> <p>Each standard time unit is automatically divided into the appropriate number of smaller divisions by separators (or 'ticks'); each Quarter is divided into three months, each year has twelve divisions, each day has 24 divisions, and so-on. To see some of the finer divisions (such as seconds in a minute) you might have to set the 'Tick spacing' slider to the left hand end, which minimizes the width of the labeled units so that you can see more of them on the screen.</p>
<p>Show Unit Label</p>	<p>When this option is enabled, the text "Unit:<Scale>" is displayed in the corner of the timeline (top-left for top timeline and bottom-left for a bottom timeline).</p> <p>The option "Show Unit Label" is enabled by default but can be disabled to provide a cleaner looking diagram.</p>
<p>Tick spacing</p>	<p>Click on the slider and drag it left or right to decrease or increase the width of the scale divisions in the Timeline.</p> <p>If you change this setting after positioning elements on the diagram, those elements are shortened or lengthened automatically to maintain</p>

	<p>their relationship to the scale divisions.</p>
<p>Timeline Start</p>	<p>If the 'Units' field is set to 'Years', 'Quarterly', 'Months' or 'Days', this field defaults to today's date. To change this either click on the section of the date and overtype it, or click on the drop-down arrow and select another date from the calendar.</p> <p>For smaller units of time and for the 'Custom' setting, the field is blank and you can set a start value. If you do not set a start value, the first marker on the diagram defaults to 0.</p> <p>The start date or value is shown as the label of the first major section on the Timeline.</p>
<p>Timeline End</p>	<p>If the 'Units' field is set to 'Years', 'Quarterly', 'Months' or 'Days', this field is disabled and the Timeline is indefinite.</p> <p>For smaller units of time and for the 'Custom' setting, the field is blank and you can set an end value. If you do not define an end value, the unit count increments up to the marker containing the right edge of the rightmost element.</p> <p>When an end value is defined and that end is reached, the timeline loops back to</p>

	<p>the 'Timeline Start' value. This allows the single timeline to be extended using the diagram width instead of the height, documenting a different set of elements against the same timeline.</p>
Scale	<p>This field is enabled when you select 'Custom' in the 'Units' field. Type in the appropriate scale unit; the value is displayed in the top left corner of the Timeline as the Unit. See <i>Setting up a Custom Scale</i> at the end of this topic.</p>
Marker offset	<p>This field is enabled when you select 'Custom' in the 'Units' field. Type in the number of units that each major segment of the scale represents. See <i>Setting up a Custom Scale</i> at the end of this topic.</p>
Ticks	<p>This field is enabled when you select 'Custom' in the 'Units' field. Type in the number of 'ticks' to subdivide each major segment of the Timeline. See <i>Setting up a Custom Scale</i> at the end of this topic.</p>
Roadmap Position	<p>Click on the drop-down arrow and select whether to show the Timeline at the top of the Diagram View or the bottom, or in both places. ('Top & Bottom' is</p>

	particularly useful if your diagram fills the screen height.)
Timeline Height	Click on the slider and drag it to the left or right to decrease or increase the depth of the Timeline ribbon. The optimum depth keeps all the Timeline text separate and distinct without hiding too much of the diagram itself.
Timeline Color	<p>Click on the drop-down arrow and select from the standard palette the color in which to display the Timeline. The display alternates between a lighter and darker shade of the color to help distinguish between the individual segments. This shading is less clear with dark or vibrant colors.</p> <p>If you want to select a color other than those in the standard palette, click on the More Colors button and select or define the required color.</p>
Line Color	It is possible to display vertical guidelines to the diagram, issuing from the main segment boundaries (see the 'Lines at major intervals' option). Click on the drop-down arrow and select from the standard palette the color in which to

	<p>display these lines.</p> <p>If you want to select a color other than those in the standard palette, click on the More Colors button and select or define the required color.</p>
Font	<p>Click on the A icon to display the 'Font' dialog, and select the font type, style, size, color and effects to apply to the text of the Timeline.</p>
Lines at major intervals	<p>Select the checkbox to display vertical lines across the diagram, to mark the major segments of the Timeline. Deselect the checkbox to hide the lines.</p> <p>On the example diagram, the lines separate the quarters and are shown in black.</p>
Center marker labels	<p>Select this checkbox to display the segment labels in the center of the segment. Clear the checkbox to display the segment labels straddling the left edge of the segment.</p>
Use legend for phase colors	<p>Select this checkbox to apply the roadmap notation of a bar divided into colored segments representing phases to all elements. This requires a legend with</p>

	<p>'Apply auto color' enabled to exist on the diagram. Each property color you define in the Legend is represented by a color band in each element in the Roadmap. When you have set up the Legend and the Roadmap, resize the elements to span the appropriate number of unit segments that they map to. Within each element, drag the left and/or right boundary of each color segment so that they also span the number of unit segments that they align to, as illustrated in the example Roadmap.</p>
OK	<p>Click on this button to close the dialog and apply any changes you made to the settings.</p>
Cancel	<p>Click on this button to close the dialog and abort any changes you made to the settings.</p>

Setting up a Custom Scale

A Custom scale gives you the ability to create a Roadmap diagram for a process that is not mapped against time, or to give a different scale to a unit of time. For example, you might want to show the consumption of raw materials in tons over several stages, or the progress of a step taking two

minutes where the changes in flow are better mapped at 10 second intervals than at 1 second intervals.

To set up a Custom scale on a Roadmap diagram, set the fields on the 'Roadmap Options' dialog as described in the previous *Roadmap Options* table, but provide specific values for the fields described in this table.

Field	Action
Units	Click on the drop-down arrow and select 'Custom'. This setting enables the 'Scale', 'Marker offset' and 'Ticks' fields, and clears the 'Timeline Start' and 'Timeline End' fields for free-text input.
Timeline End	<p>In the blank field, type the end, cut-off or target value for the scale. For example, a target revenue or a maximum cost, period or capacity.</p> <p>When an end value is defined and that end is reached, the timeline shows the 'Timeline Start' value again and increments from there. You can use this repeated scale to set up a different group of elements under the same timeline.</p> <p>If you do not define an end value, the unit count increments up to the marker containing the right edge of the rightmost element.</p>

Scale	Type in the required unit of measurement, in numerals, text or both; you might specify, for example, units of distance, weight or monetary value, or a percentage. The value is displayed in the top left corner of the Timeline as the Unit.
Timeline Start	In the blank field, type the start value for the scale. For example, any wait period at the start of the process, or minimum balance or brought-forward balance for accounting scenarios. The Timeline then increments from that value. If you do not specify a value, the Timeline starts at 0.
Marker offset	<p>Type in the number of units that each <i>major</i> segment of the scale represents. You set this value in combination with the 'Scale' field; you might, for example, set the scale to '\$US 1000' and the offset to '1', or the scale to simply '\$US' and the offset to '1000'.</p> <p>The offset can also represent the natural unit of progression, so if one output delivers two units you might set the offset to 2 and the scale reads '2, 4, 6, 8' and so on, or if the delivery is 3 units set an offset of 3 and the scale reads '3, 6, 9, 12'</p>

	and so on.
Ticks	Type in the number of separators (or 'ticks') you want to display to subdivide each major segment of the Timeline. The number of ticks is 1 less than the number of subdivisions. For example, in the 'Year' unit there are 11 ticks giving 12 subdivisions, one for each month of the year.

Custom Diagram Styles

Enterprise Architect provides a diagram drawing style that helps you to create new diagrams or cast existing diagrams as simple, colorful and direct illustrations of modeling and project management concepts, similar to the style of drawings created in Visio or Powerpoint. Elements are rendered with a border color, fill color, no gradients and a simplified appearance. They can also be rendered in a range of different shapes.

This minimalist drawing style is much used by architects, business users, CEOs and many others as a preferred means of conveying ad-hoc information concerning a business capability, architecture, system interaction or any of several other scenarios. In providing this capability, Enterprise Architect dramatically increases the reach and audience for its range of diagrams. Coupled with WebEA and Prolaborate, the facility offers end users instant access to attractive and familiar diagrams that avoid the formal, technical appearance and complexity of UML and technology diagrams.

The custom drawing style can be applied to any UML diagram, so that a user can still use the correct modeling element types (and can toggle back to the formal rendering of these elements) but they can give them a completely novel rendering style and appearance.

Custom Diagram Style is available in the Corporate, Unified and Ultimate Editions of Enterprise Architect from release 15.0 onwards.

Access

<p>Working from a template or Pattern</p>	<p>Display the Model Builder (right-click on a Package and select the option 'Model Builder (pattern library)', click on the <perspective name> button and select 'Analysis > Custom Diagram Style'.</p> <p>Select one of the three templates or six examples, and work on those to develop your own diagrams. Note that these templates are intended to illustrate the feature rather than provide a framework for modeling - customizing is, after all, doing things your way! We recommend generating a model from the Custom Drawing Styles template (the diagram is shown in the <i>Examples of Style Rendering</i> section of this topic) and experimenting with the shapes and features to help you develop your own rendering of elements.</p>
<p>Apply the style to an existing diagram</p>	<p>Open the Properties window (Ctrl+2) and the required diagram, and click on the diagram background. On the 'Diagram' tab of the Properties window, expand the 'Appearance' segment and select the</p>

'Custom Style' checkbox. Alternatively, double-click on the diagram background to display the 'Properties' dialog, select the 'Elements' tab and select the 'Custom Draw' checkbox.

All elements on the diagram are rendered as white rectangles with the element name and stereotype in the center.

However, structural elements (such as a Ports) are not rendered differently in Custom Style.

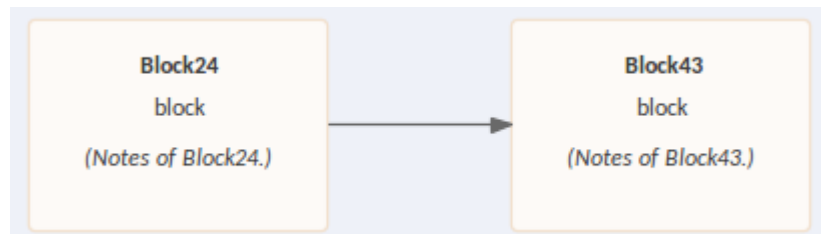

If the element has Notes, these are also displayed in parentheses. No other element properties or characteristics are shown.

Connectors on the diagram are simplified to a solid line and basic arrowhead, except for stereotyped connectors which are also not rendered differently in Custom Style.

You now click on each element in turn and click on the  icon to define the rendering as described in the rest of this topic. You can equally apply each feature to a selection of multiple elements.

Enable the style for an individual element

If the 'Custom Style' option on the diagram is not selected, you can apply the style to an individual element on the diagram. Right-click on the element and select the 'Appearance | Enable Custom Draw Style' context menu option. The element - alone on the diagram - is shown as a white rectangle as shown in the earlier example.

When either of the 'Enable Custom Draw Style' or diagram 'Custom Style' options are selected, when you click on the element and on the  this Format toolbar displays next to the element:



Examples of Style Rendering

In the descriptions provided in this topic, refer to this diagram as an illustration of the options and their effects.

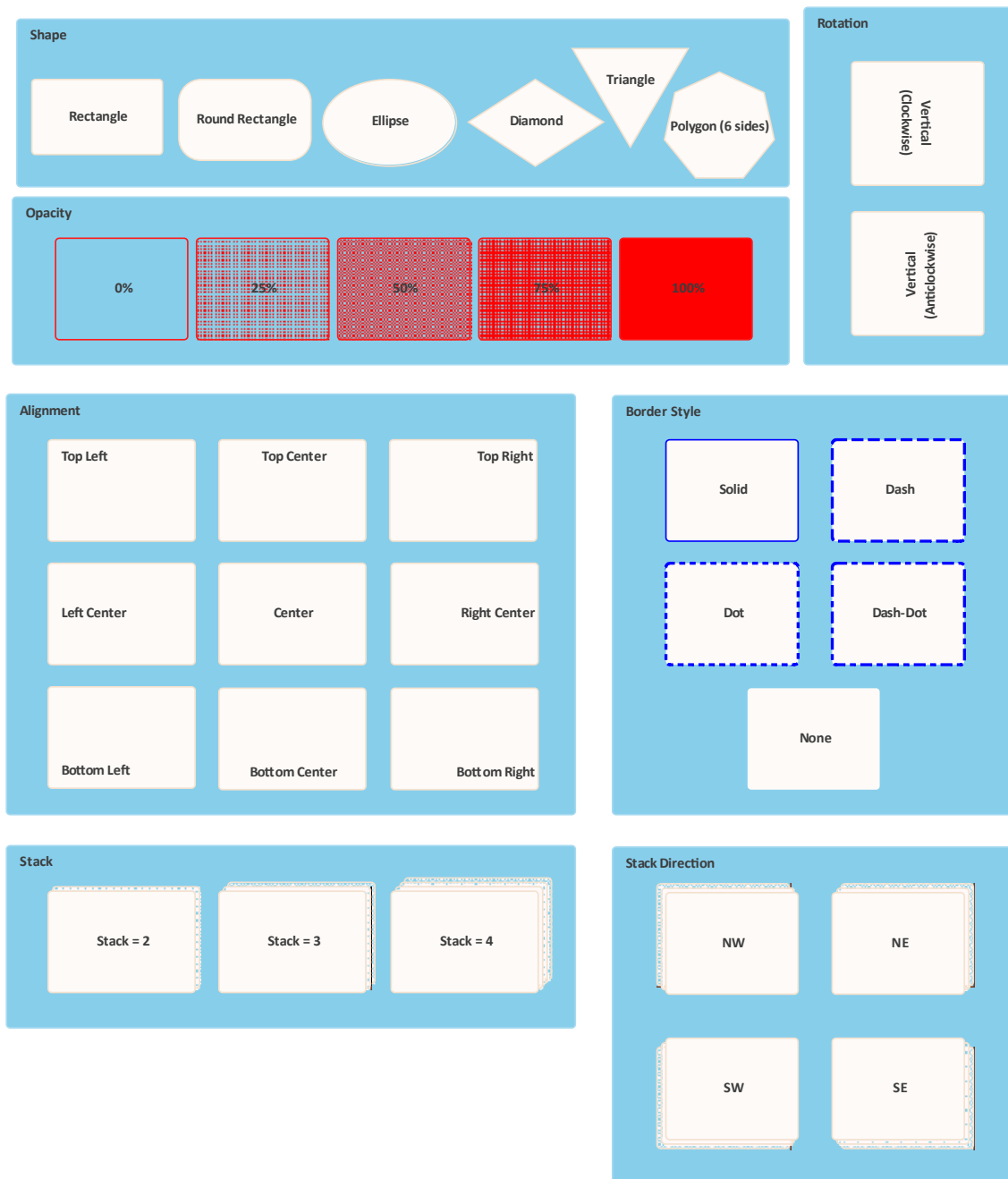

Apply Styles

Style	Options
Set the Shape	On the Format toolbar click on the  icon at the right-hand end of the row of

icons. In the drop-down menu, click on the appropriate shape option to render the element as a:

- Rectangle (the default)
- Rounded-corner rectangle
- Ellipse (which you can drag into the shape of a circle)
- Diamond
- Polygon, with a submenu to define the shape as having 5, 6, 7, 8, 9 or 10 sides, or
- Triangle

See the 'Shape' panel of the example diagram. The 'None' option here turns custom styles off for the element and returns it to 'normal' model notation rendering.

Regardless of its visible shape, each element has a rectangular operation boundary and the positioning options described in this table work within that rectangle. You might find, therefore, that some of the position options on non-rectangular shapes can place the element text and icons outside the visible shape.

Note that the icon in the toolbar updates to reflect the current shape of the



	element.
<p>Set the Opacity of the Element Fill</p>	<p>You can set the element shape to be transparent (so that the diagram background and any overlapped elements show through) or various degrees of opacity that overshadow the overlapped elements. If you set 100% opacity, the element fill is solid and totally hides the background and any overlapped elements.</p> <p>To set the opacity, on the Format toolbar click on the  icon and select from:</p> <ul style="list-style-type: none"> • 0% • 25% • 50% • 75% and • 100% <p>See the 'Opacity' panel of the example diagram.</p> <p>Note that the element boundary, text and icon (if set) are not affected when setting the Opacity.</p>
<p>Set the Text Position</p>	<p>On the element, display of the name, stereotype and notes defaults to the center of the element. You can reposition the text to eight other points in the element</p>

	<p>shape, or place the text in a custom position.</p> <p>To position the text, on the Format toolbar click on the  icon and select from these options:</p> <ul style="list-style-type: none"> • Top Left • Top Center • Top Right • Left Center • Center • Right Center • Bottom Left • Bottom Center • Bottom Right • Custom <p>If you select the 'Custom' option, the element text is displayed as a label just beneath the element, and you can drag it to whatever position inside or outside the element you prefer. You can also use any of the standard label formatting facilities. See the 'Alignment' panel of the example diagram. Note that the icon in the toolbar reflects the current position of the text in the selected element.</p>
<p>Set the Text</p>	<p>The text in the element defaults to</p>

Orientation	<p>horizontal, reading left to right. If you prefer, you can set the element name to a vertical orientation with characters in the same plane, reading either top to bottom or bottom to top. Stereotype and Notes text are hidden in these vertical settings. To set the orientation, on the Format toolbar click on the  icon and select from these options:</p> <ul style="list-style-type: none">• None (leave horizontal)• Vertical (clockwise)• Vertical (anticlockwise) <p>See the 'Rotation' panel of the example diagram. Note that the icon in the toolbar reflects the current orientation of the name of the selected element.</p>
Add an Icon to an Element	<p>While the diagram has Custom Style enabled, you can add icons to either the existing elements or to new elements generated as part of the process. The default position of the icon is in the top right corner of the element boundary, but you can move the icon to other points. To set the icon on an element in the diagram, select an Image Asset in the Browser window and drag it onto the diagram, either onto the existing element or into a space in which to create a new</p>

element. A short menu displays:

- If you are adding the image to an existing element, select the 'Set as Icon' option
- If you are creating an element that contains the icon, select the 'Add as element with icon' option



After adding the icon, click on the element and on the , then in the Format toolbar click on the  icon and on 'Position', and select from these options:



- Top Left
- Top Center
- Top Right
- Bottom Left
- Bottom Center
- Bottom Right

Note that the toolbar icon reflects the current position of the icon in the selected element.

Any size of image can be set into the Image Asset when it is used as an icon, but you can control its display size in the element. Click again on the  icon and on 'Size', and select from these options:

- 16x16 pixels
- 24x24 pixels



	<ul style="list-style-type: none"> • 32x32 pixels (the default) • Image Size (the size of the image in the Image Asset; do not select this option unless the image is already small enough to act as an icon)
<p>Apply Border Style</p>	<p>To change the border line style, on the Format toolbar click on the  icon (second from the right) and select a line style of:</p> <ul style="list-style-type: none"> • Solid • Dashed • Dotted • Dashed-and-Dotted • None <p>See the 'Border Style' panel of the example diagram.</p>
<p>Apply Stacked Image</p>	<p>On the diagram or element with Custom Style enabled, you can make an element represent several iterations of its object by adding a set of between 1 and 4 'stacked' element edges off one of the corners of the element.</p> <p>To add 'stacking', click on the  icon and select 'Stacks' and the number of edges to add.</p> <p>Click on the  icon again (notice that it</p>

	<p>now represents the number of 'stacks' you set) and select 'Direction' and one of these options:</p> <ul style="list-style-type: none"> • NW (top left corner) • NE (top right corner; the default) • SW (bottom left corner) • SE (bottom right corner) <p>See the 'Stack' and 'Stack Direction' panels of the example diagram. Note that the icon in the toolbar also reflects the direction of stacking in the selected element.</p>
<p>Set the Font, Border Width and Colors</p>	<p>These are standard options on the Diagram and Element floating toolbars, and apply to the Custom Styles as well as to normally rendered elements.</p> <p>Click on the element and on the  icon to the right of the element to display the Element toolbar, then:</p> <ul style="list-style-type: none"> • To show the element text in a different font, click on the  icon; the 'Font' dialog displays, on which you can set the font type, style, size, color, effects and script type from the lists in each field • To apply different colors, click on one or more of the  icons to set

	<p>the color of the text, element fill and/or element border respectively; select the appropriate color from the color palette in each case or, if necessary, click on the More Colors button to define a custom color to use</p> <ul style="list-style-type: none">• To change the width of the element borders, click on the 'spinner' arrows to set the border width to a value between 1 (the thinnest, default width) and 5 (the thickest width)
--	---

Subordinate Text

In Custom Diagram Style, if the element name does not provide a sufficiently specific visual reference, you can use the 'Description' Tagged Value to display a secondary text string on the element. Apply these simple steps:

1. Click on the element and, if necessary, press Ctrl+2 to display the Properties window for the element.
2. Click on the 'Tags' tab in the Properties window, and click on the  icon in the toolbar to create a new Tagged Value.
3. In the 'Tagged Value' dialog, in the 'Tag' field type Description, and in the 'Value' field type <memo>. Click on the OK button.
4. On the 'Tags' tab, click on the  icon at the right-hand

end of the 'Description' field, and in the 'Tagged Value Note' dialog type the text string to display. Click on the OK button.

5. The element on the diagram now has a line across it underneath the name (depending on the other Custom Styles you have applied) with the text string below it.

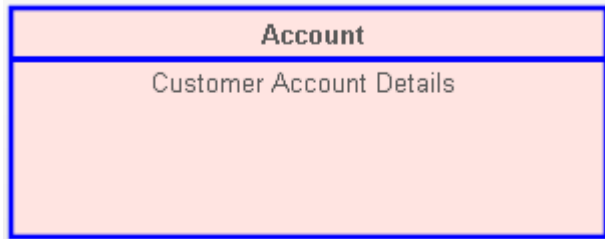

Notes

- Having applied custom styles to a diagram, you can toggle between the custom format and the formal notation simply by enabling and disabling the 'Custom Style' option.
- Be aware that manual changes to colors, border width and element position and size are reflected in both formats, but the system can automatically resize elements to accommodate text and compartment content, and that will then be reflected in the custom appearance of the diagram when you switch to it; therefore diagram layout might be altered as you toggle between the formats
- Similarly, if you reduce an element to the minimum size in Custom Style, when you deselect the 'Custom Style' option to turn it off, the element returns to its original size to display all of its visible content
- Custom Style and Info View Style are mutually exclusive;

you do not apply both styles to the same element

The Pan & Zoom Window

The Pan & Zoom window provides a 'birds-eye' view of diagrams. It enables you to navigate quickly around large diagrams.

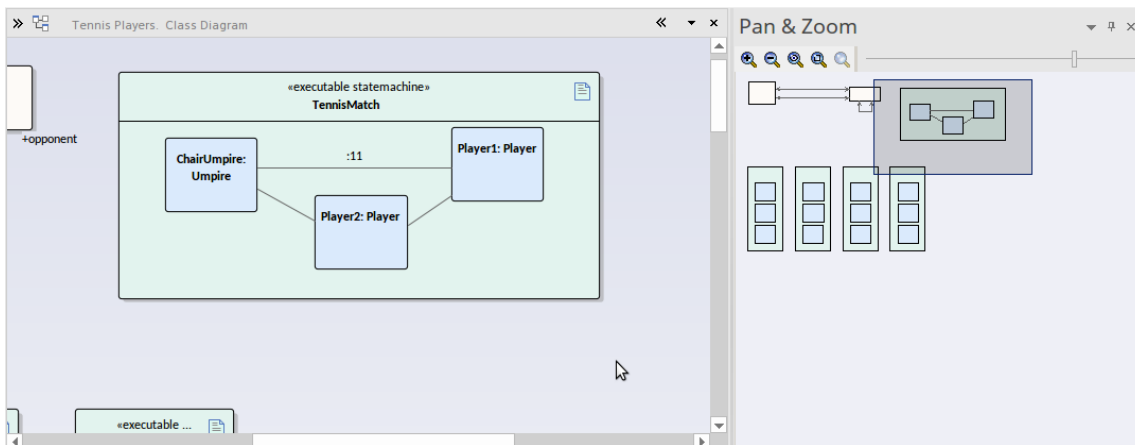

Note that Dashboard diagrams are designed to automatically size to the display screen, so the Pan & Zoom facilities are grayed out when these diagrams are opened.

Access

Ribbon	Layout > Tools > Pan and Zoom
Keyboard Shortcuts	Ctrl+Shift+4

Reference

Topic	Detail
View	<p>The window shows a reduced image of the whole diagram.</p> <p>The shaded box represents the viewed area, displayed on the open diagram.</p>
Toolbar	<p>The toolbar provides these functions (in order):</p> <ul style="list-style-type: none">• Zoom In• Zoom Out• Zoom to fit diagram• Zoom to fit page• Zoom to 100%• Zoom Slider
Use	<p>Open the required diagram.</p> <p>Move the cursor onto the shaded box inside the Pan & Zoom window.</p> <p>Hold down the mouse button as you move the cursor to move the shaded box over the open diagram. As you do this, the corresponding area is brought into view on the open diagram.</p> <p>To zoom, use either the Zoom Slider (drag the rectangle along the line) or the buttons located on the tool bar (click on</p>

	the appropriate button).
--	--------------------------

Auto Refresh

When working in a team environment, the Auto Refresh feature assists in collaborative diagram design, by providing improved support for multiple people giving input on the same diagram and allowing users to monitor changes on a specific diagram.

The automatic refresh mode is enabled when a user selects a refresh interval on a diagram. This effectively prevents all users from editing the diagram. The model database is polled to check for changes to the diagram and the diagram is reloaded from the database when changes are detected. To make changes to the diagram, you must choose the 'Pause & Edit' option, which allows you to make updates to the diagram. Once you have finished making changes, you select the 'Resume' option, whereupon diagram updates are automatically saved to the database.

As a best practice, it is recommended that you lock the diagram before enabling 'Pause & edit', and press Ctrl+S at appropriate times so that the updated diagram is visible to other users.



This feature is available in Enterprise Architect version 16.0 and later.

Access

Ribbon	Layout > Auto Refresh > Auto Refresh
--------	--------------------------------------

Context Menu	Right-click on diagram background Collaborate > Auto Refresh
--------------	--

Menu Options

These options are used to enable or disable the functionality, to set the diagram refresh interval and to 'pause' the auto-refresh setting to allow editing of the diagram. When enabled a clock icon  is shown in the diagram icon panel. When *Pause & Edit* is selected the pause icon  is shown.

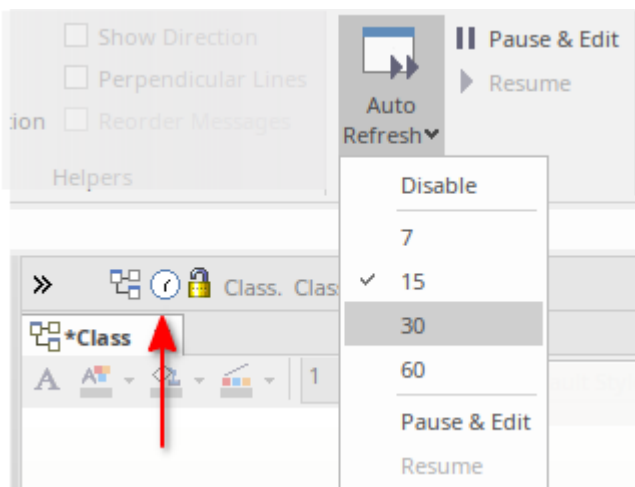

Option	Action
Disabled	This is the default setting for all diagrams. Click on the option if Auto Refresh has been put into operation on the diagram and you want to turn it off. Clicking on this option will also save any pending changes to the diagram.

7	Enable automatic refresh mode for the current diagram and set the refresh interval to 7 seconds.
15	Enable automatic refresh mode for the current diagram and set the refresh interval to 15 seconds.
30	Enable automatic refresh mode for the current diagram and set the refresh interval to 30 seconds.
60	Enable automatic refresh mode for the current diagram and set the refresh interval to 60 seconds.
Pause & Edit	Pause automatic refreshing of the diagram and allow you, the current user, to edit the diagram.
Resume	Save any outstanding changes to the diagram and resume automatic refresh of the diagram, preventing any further modification to it until either the 'Disabled' or 'Pause & Refresh' option is applied.

Layout Diagrams

As you develop a model diagram and add more elements and connectors to it, you can apply one of a number of formats to automatically lay out specific areas or sets of elements in the diagram in a structured arrangement. If the diagram is very simple, you could even use this facility to lay out the entire diagram.



Additionally, you can provide filters and parameters for two or three types of layout and then 'chain' the layouts so that they are executed in sequence to result in a more refined layout. You can select a system-defined chain, or one that you have created yourself.

Access

Ribbon	Layout > Tools > Diagram Layout > Open Diagram Layout Tools
Context Menu	Right-click a selected element on a diagram Layout Selected Elements (available only when multiple elements are selected)
Other	Right-click on any toolbar Diagram Layout Tool : Select a Layout  Apply Layout

Lay out elements on a diagram

Step	Action
1	<p>Select the elements to lay out on the currently-active diagram - hold Shift or Ctrl while you click on each required element, or hold the mouse button down while you sweep over the area containing the required elements.</p> <p>If no elements are selected on the active diagram, then all elements on the diagram are laid out (except where otherwise documented).</p>
2	<p>Click on the drop-down arrow on the top left field of the Layout Tools window, and select the required layout type:</p> <ul style="list-style-type: none">• Circle/Ellipse• Box• Per Page• Digraph• Spring• Neaten• Converge/Diverge• Fan Relations

	<ul style="list-style-type: none">• Auto Route <p>The layout type determines the fields presented in the window, therefore the appropriate fields are described separately for each layout type.</p> <p>If you want to apply a sequence or chain of diagram layouts to a diagram, select either:</p> <ul style="list-style-type: none">• The appropriate system-defined chain name, or• The name of a chain you have created yourself <p>You can create and modify a 'Layout Chain' by clicking on the  button in the dialog toolbar.</p>
3	<p>When you have completed the fields, click on the  button.</p> <p>The selected elements are reorganized into the pattern format you have selected and according to the options you have chosen.</p>
4	<p>If you do not want to work with the new layout, click on the Undo button in the toolbar ().</p>

Notes

- If you have adjusted the settings for a layout, you can automatically apply those settings to another diagram by selecting the 'Layout > Tools > Diagram Layout > <layout name>' ribbon option when you have opened the diagram
- You can also automatically lay out an entire diagram,

without specifying any format or filters, using the alternative Layout Diagram facility

- Nested elements will remain within their parent element when applying a layout

Circular/Elliptical Layout

The Circle and Ellipse layouts arrange the selected elements in a circle or elliptical pattern, using the largest horizontal and vertical element edge in the set of elements when calculating the radius of the layout arc.

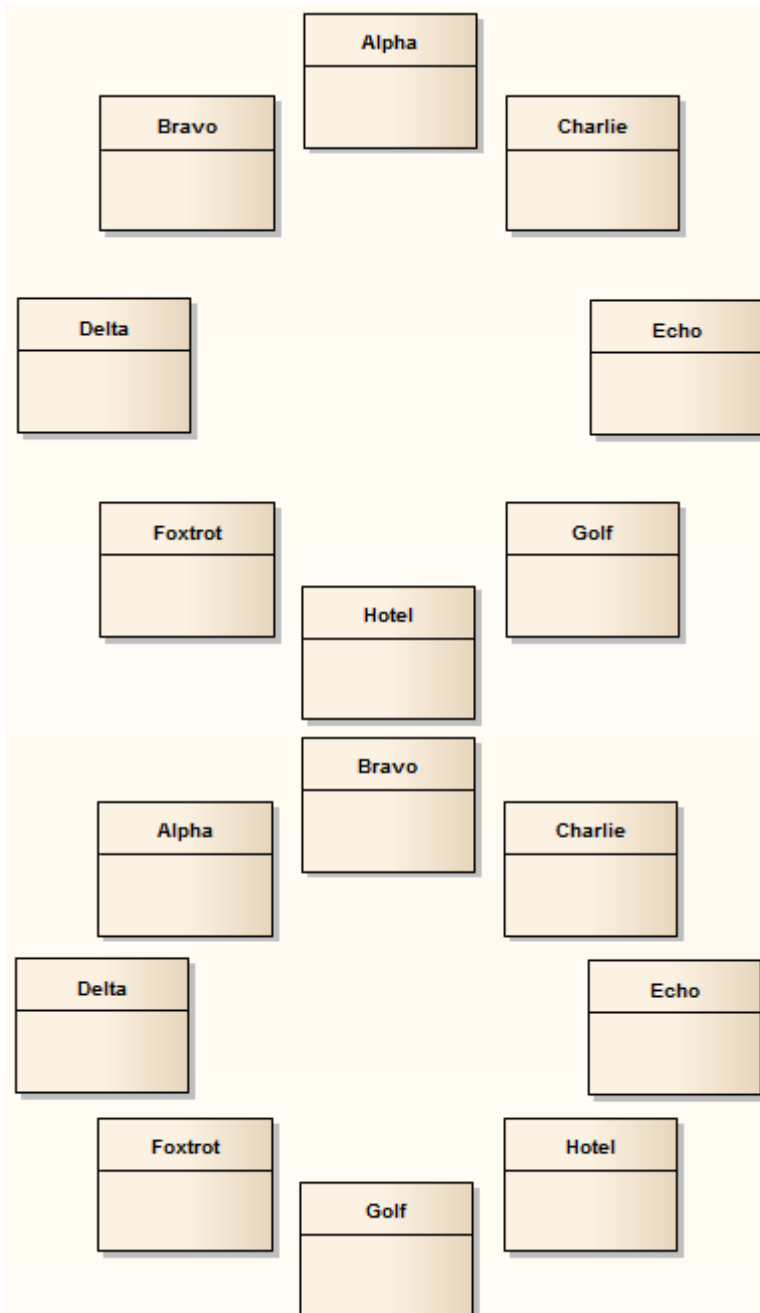

Invoke the Circular or Ellipse layout

Diagram A - Top To Bottom Layout

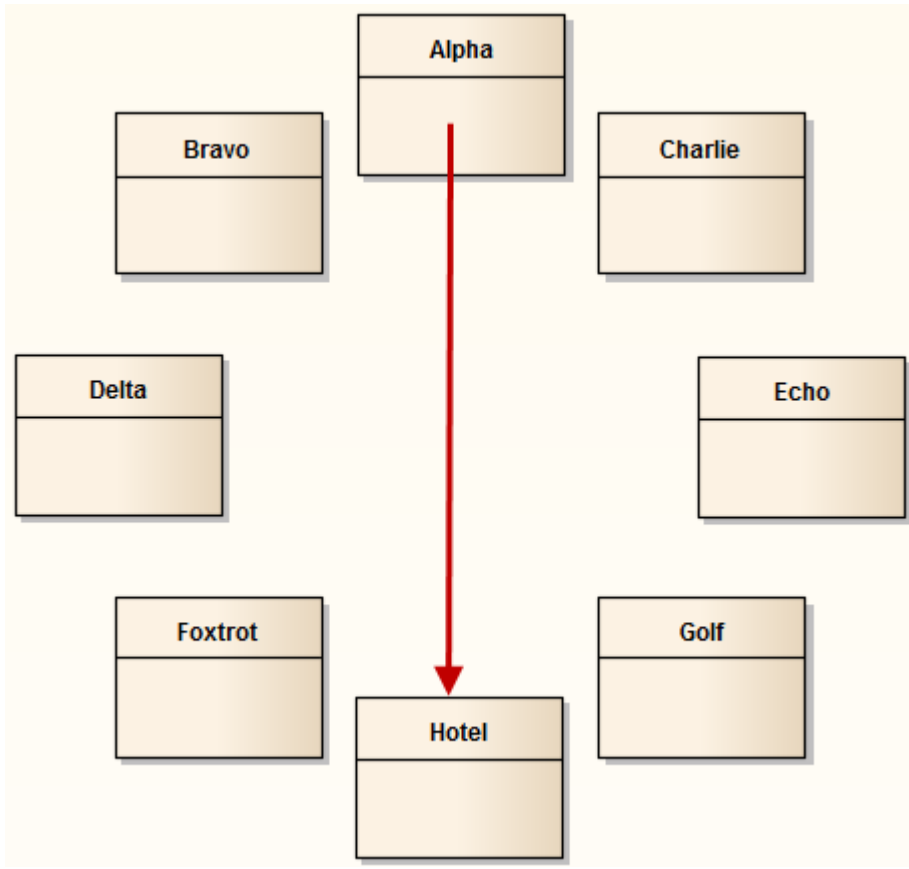

Step	Action
1	Follow the general <i>Layout Diagrams</i> procedure, and at step 2 select either 'Circle' or 'Ellipse' as required.
2	Click on the drop-down arrow in the 'Sort By' field and select the required sort parameter: <ul style="list-style-type: none">• None - elements are passed to the specified layout in the order in which they appear on the original diagram (left to right, top to bottom)• Area (Ascending) - elements are passed to the

	<p>specified layout in order of the screen space they occupy, smallest to largest</p> <ul style="list-style-type: none">• Area (Descending) - elements are passed to the specified layout in order of the screen space they occupy, largest to smallest• Name (Ascending) - elements are passed to the specified layout in alphanumeric order, based on the element name• Name (Descending) - elements are passed to the specified layout in reverse alphanumeric order, based on the element name• Element Type - elements are grouped by type (for example, Class, Use Case) and in alphanumeric order within the group by name
3	<p>Under the 'Placement' option, select either:</p> <ul style="list-style-type: none">• Top to Bottom - the elements are positioned in the required order, zig-zagged across the perimeter of the circle or ellipse, as in Diagram A• Circular - the elements are placed in the required order, clockwise around the perimeter of the circle or ellipse, as in Diagram B
4	<p>Select the 'Center focused element' checkbox to put the last-selected element (the one with the hashed border) in the center of the circle or ellipse, as in Diagram C.</p>

Diagram B - Circular Layout

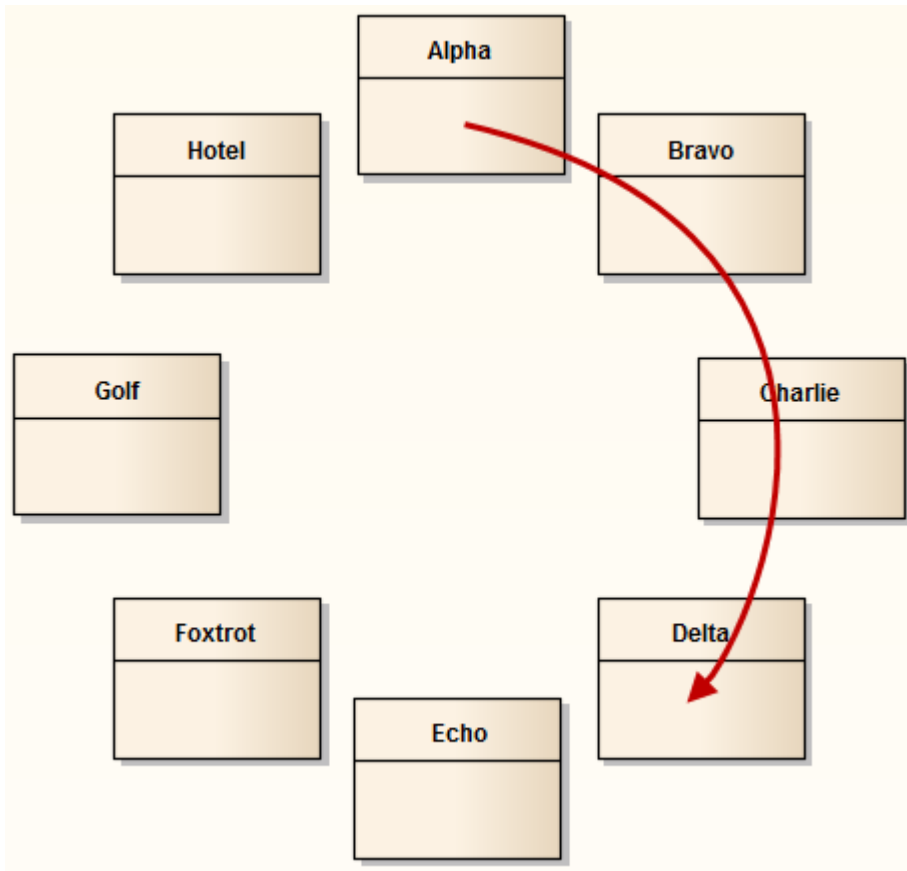
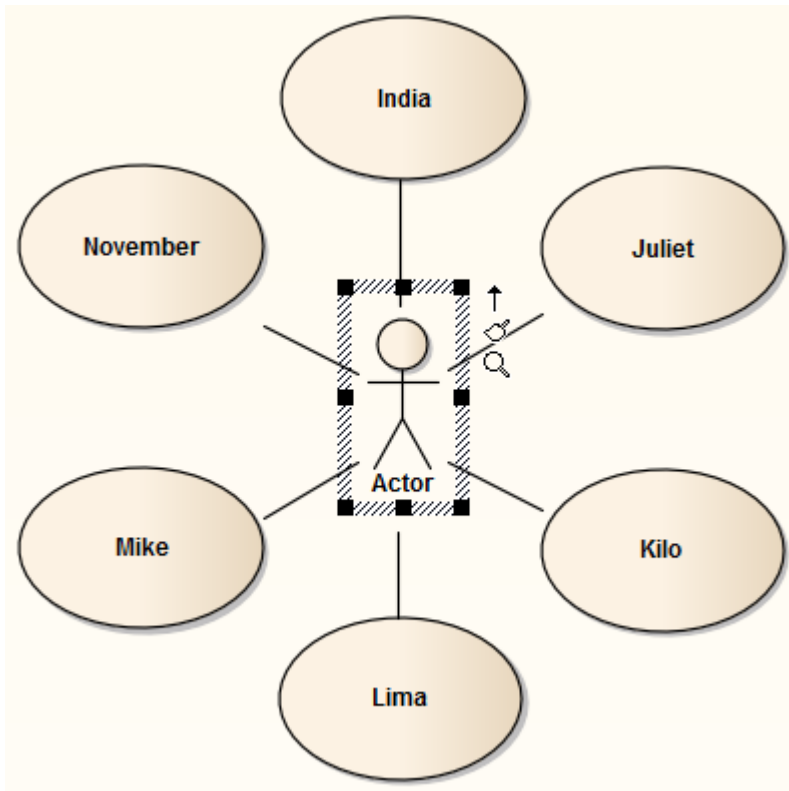
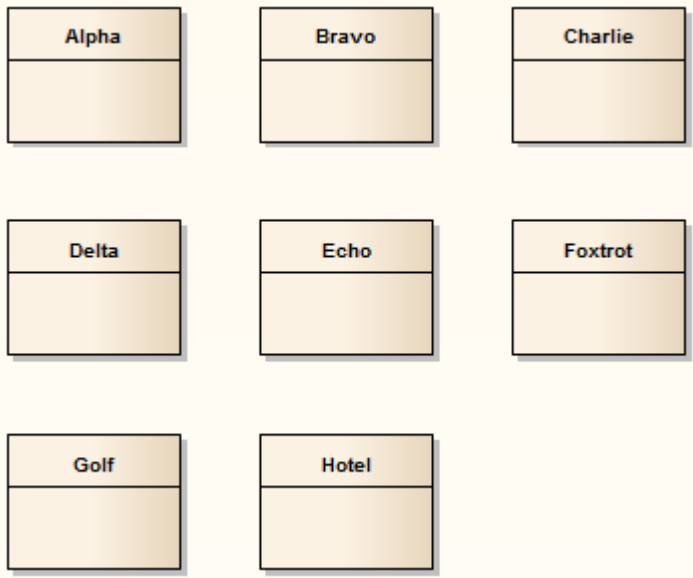

Diagram C - Center Focused Element



Box Layout

The Box layout arranges the set of selected elements into a square grid.



The dimensions of the box are determined by the number of columns that either:

- You set manually or
- The system automatically sets to a value that results in the same number of columns and rows (for example, 5, 6, 7, 8 or 9 elements would all be arranged in a three-column rectangle).

Invoke the Box layout

Step	Action
1	Follow the general <i>Layout Diagrams</i> procedure, and

	at step 2 select 'Box'.
2	<p>Click on the drop-down arrow in the 'Sort By' field and select the required sort parameter:</p> <ul style="list-style-type: none"> • None - elements are passed to the specified layout in the order in which they appear on the original diagram (left to right, top to bottom) • Area (Ascending) - elements are passed to the specified layout in order of the screen space they occupy, smallest to largest • Area (Descending) - elements are passed to the specified layout in order of the screen space they occupy, largest to smallest • Name (Ascending) - elements are passed to the specified layout in alphanumeric order, based on the element name • Name (Descending) - elements are passed to the specified layout in reverse alphanumeric order, based on the element name • Element Type - elements are grouped by type (for example, Class, Use Case) and in alphanumeric order within the group by name
3	In the 'Padding (px)' field, type the vertical and horizontal distance between elements, in pixels.
4	<p>Select the appropriate element distribution option:</p> <ul style="list-style-type: none"> • Automatically distribute: Automatically calculate

	<p>the dimensions of the box (the square root of the number of selected elements; for example, 16 elements create a 4x4 box)</p> <ul style="list-style-type: none">• Specify distribution: Manually define the width of the box, in columns
5	If you selected 'Specify Distribution', in the 'Columns' field type the required number of columns.

Per Page Layout

The Per Page layout divides each diagram page into a number of cells, which house the selected elements. The number of cells per page is determined by the page distribution parameter.



Invoke the Per Page layout

Step	Action
1	Follow the general <i>Layout Diagrams</i> procedure, and

	at step 2 select 'Per Page'.
2	<p>Click on the drop-down arrow in the 'Sort By' field and select the required sort parameter:</p> <ul style="list-style-type: none">• None - elements are passed to the specified layout in the order in which they appear on the original diagram (left to right, top to bottom)• Area (Ascending) - elements are passed to the specified layout in order of the screen space they occupy, smallest to largest• Area (Descending) - elements are passed to the specified layout in order of the screen space they occupy, largest to smallest• Name (Ascending) - elements are passed to the specified layout in alphanumeric order, based on the element name• Name (Descending) - elements are passed to the specified layout in reverse alphanumeric order, based on the element name• Element Type - elements are grouped by type (for example, Class, Use Case) and in alphanumeric order within the group by name
3	In the 'Padding (px)' field, type the vertical and horizontal distance between cells, in pixels.
4	<p>Select the appropriate page distribution option:</p> <ul style="list-style-type: none">• Automatically distribute: automatically calculate

	<p>the optimum number of cells, taking into consideration the largest horizontal and vertical element edges</p> <ul style="list-style-type: none">• Specify distribution: manually enter the per page grid dimensions
5	<p>If you selected 'Specify Distribution', in the 'Rows' and 'Columns' fields type the required number of rows and columns.</p>
6	<p>Select the 'Center Elements' checkbox to place each element in the center of its cell; otherwise the element placement defaults to the top left corner of the cell.</p>
7	<p>In the 'Start Page' field, type the number from which to start the page numbering; pages begin at the top left and continue horizontally to the right.</p>

Digraph Layout

The Digraph layout arranges the selected elements into a directed graph ('digraph' for short). The Digraph attempts to highlight the hierarchy of the elements while keeping the direction of all connectors pointing to the same edge of the diagram.

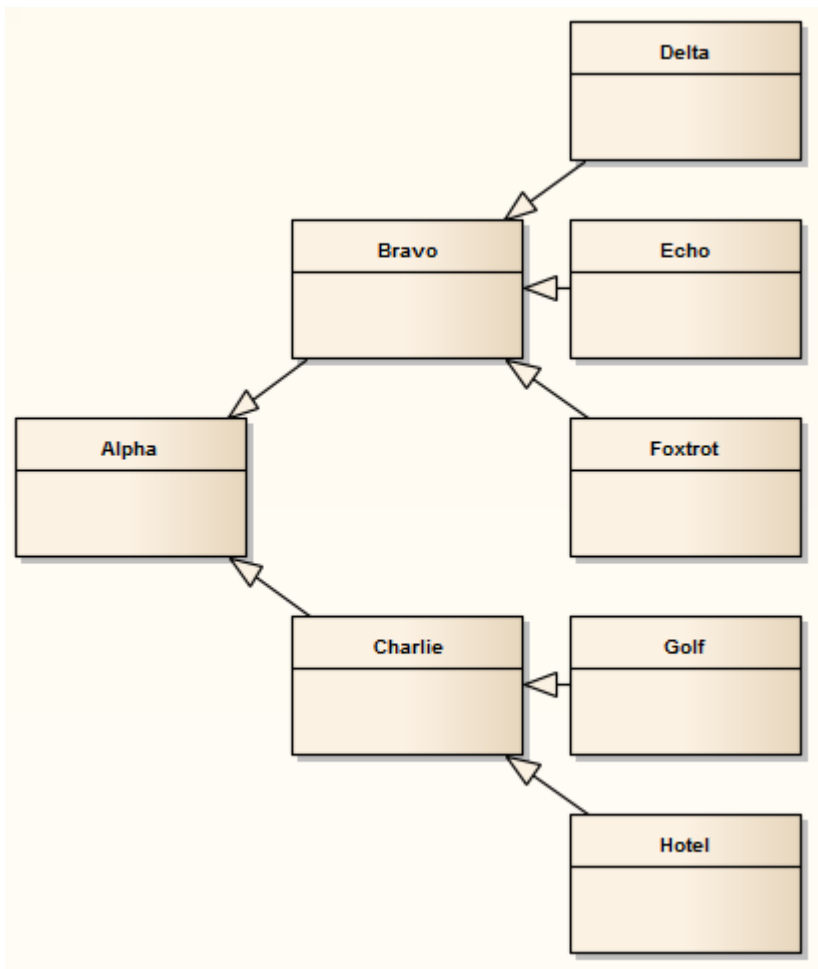

The Digraph layout provides the same behavior as the Automatic Diagram Layout.

Spring Layout

The Spring layout uses a force-directed approach to arrange the selected elements organically. It employs a physical analogy to lay out elements; each element is treated as a particle with a like electrical charge that repels other elements. Connectors act as springs (hence the name Spring layout) that draw connected elements back together. The layout is good for highlighting clusters of related objects and identifying symmetry in the graph.

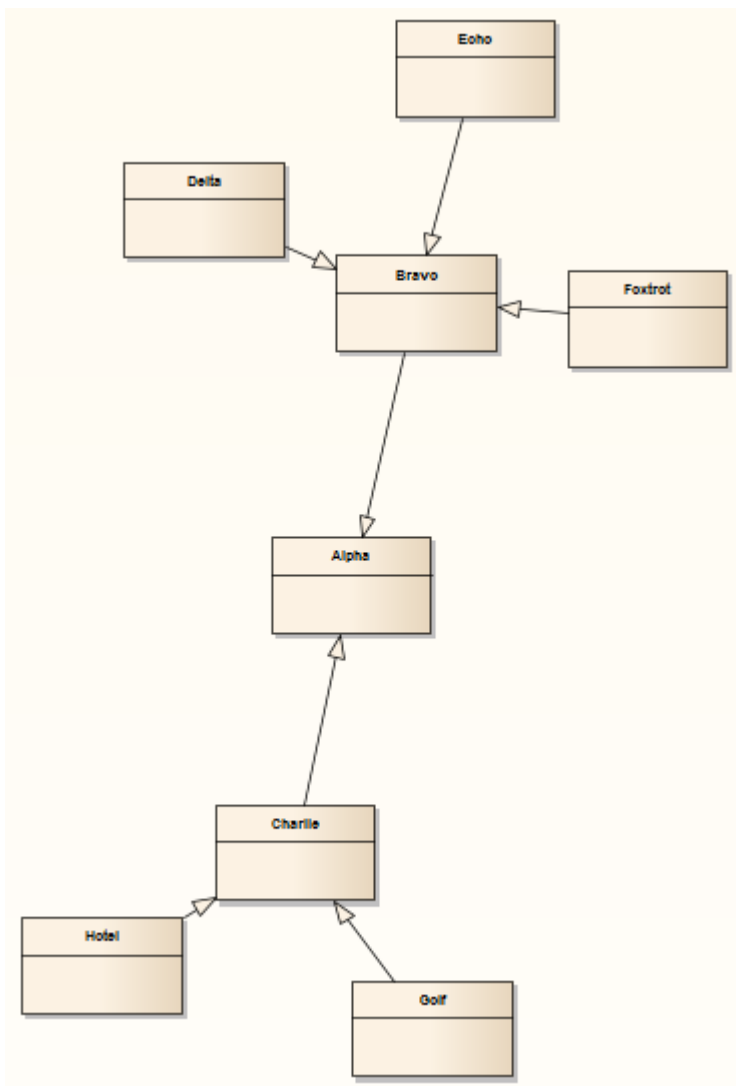

Invoke the Spring layout

Step	Action
1	Follow the general <i>Layout Diagrams</i> procedure, and at step 2 select 'Spring'.
2	In the 'Iterations' field, type the number of iterations, or rounds, to perform to reach the final layout. The layout is developed over several iterations; depending on the complexity of the graph, increasing the number of iterations produces a better result but takes longer to calculate.
3	If the diagram contains elements that significantly vary in size, and that might overlap in the final layout, select the 'Scale to prevent overlap' checkbox to scale up the positions of the selected elements (preserving size) until no elements overlap.

Neaten Layout

The Neaten layout attempts to pull the selected elements into a grid based on their horizontal and vertical proximity to each other. That is, the layout pulls elements that are roughly aligned into a neater arrangement. Elements that share the same row or column are aligned based on the 'Column' and 'Row Snap' parameters. The arrangement shown for the Spring layout, when the Neaten layout is applied, might resemble this:

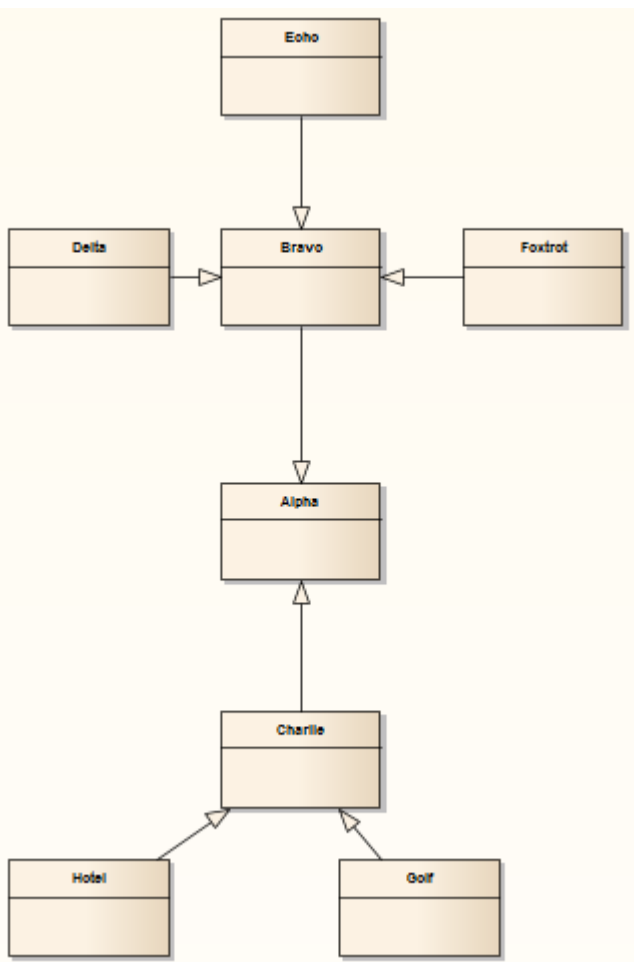

Invoke the Neaten layout

Step	Action
1	Follow the general <i>Layout Diagrams</i> procedure, and at step 2 select 'Neaten'.
2	<p>In the 'Threshold (px)' field type the separation, in pixels, up to which elements are considered to be in the same row or column.</p> <p>A higher threshold value produces a tighter result, pulling elements that are far distant into the same row or column. A lower threshold value provides for a larger number of rows and columns.</p>
3	<p>In the 'Column Snap' field, click on the drop-down arrow and select the appropriate alignment for elements in the same column:</p> <ul style="list-style-type: none">• Left - elements are aligned with the left edge of the left-most element in the column• Center - elements are aligned with the vertical center of the center-most element in the column• Right - elements are aligned with the right edge of the right-most element in the column
4	<p>In the 'Row Snap' field, click on the drop-down arrow and select the appropriate alignment for elements in the same row:</p> <ul style="list-style-type: none">• Top - elements are aligned with the top edge of the

	<p>highest element in the row</p> <ul style="list-style-type: none">• Center - elements are aligned with the horizontal center of the center-most element in the row• Bottom - elements are aligned with the bottom edge of the lowest element in the column
--	---

Notes

- To prevent elements from overlapping in the neatened layout, check that the appropriate left, right, top, bottom, vertical center or horizontal center values of the elements (as dictated by the 'Column Snap' and 'Row Snap' options you select) are greater than the value in the 'Threshold' field

Converge/Diverge Layout

The Converge layout attracts the set of selected elements towards the center of their bounding rectangle. Conversely, the Diverge layout repels the set of selected elements away from the center of their bounding rectangle. The Converge/Diverge layout also tries to maintain connector angles if an element in the set contains a connector with waypoints.

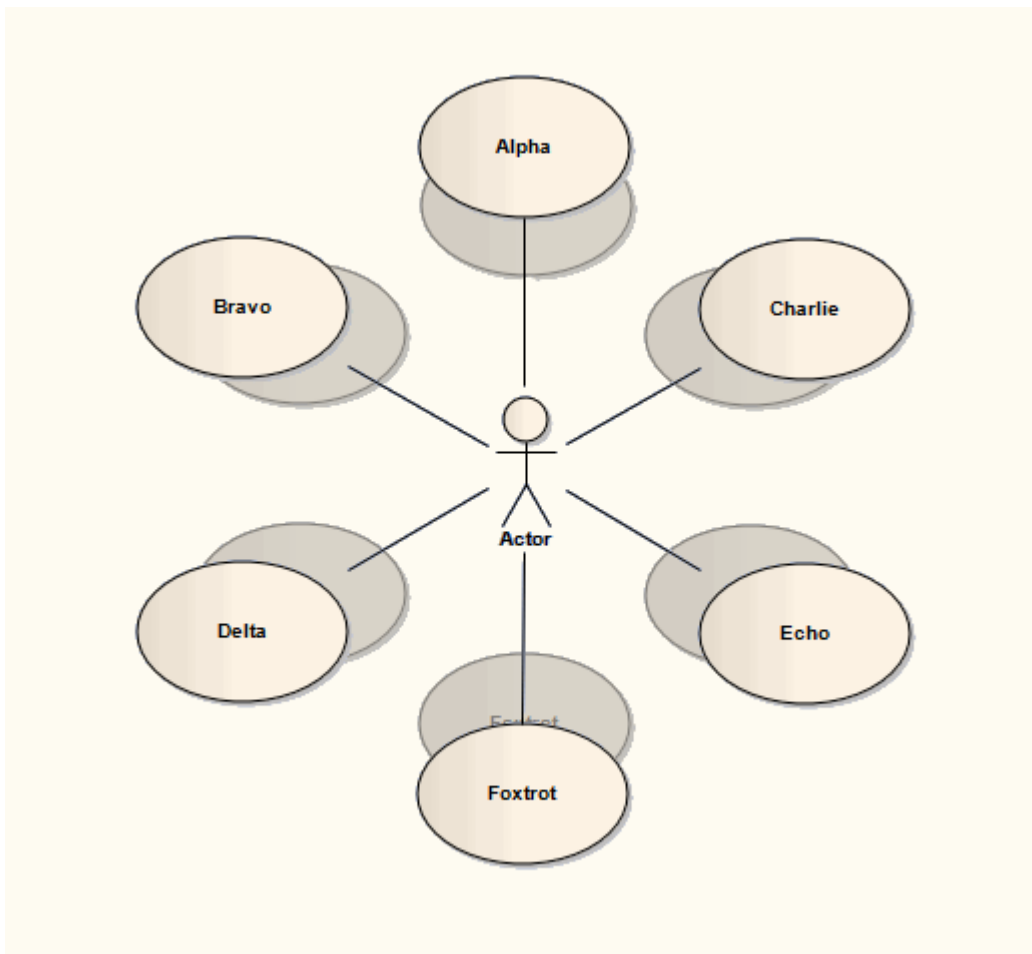

Invoke the Converge/Diverge layout

Ste	Action
-----	--------

p	
1	Follow the general <i>Layout Diagrams</i> procedure, and at step 2 select 'Converge/Diverge'.
2	Select the radio button for the required direction of the layout: <ul data-bbox="277 645 1394 891" style="list-style-type: none">• Converge - attracts the set of selected elements to the center point• Diverge - repels the set of selected elements from the center point
3	<p>Set the 'Amount (%)' slider to the required percentage. A smaller percentage provides finer control of the change in layout.</p> <p>The slider determines how far the elements are moved towards or away from the center point; the movement is the element's current distance from the center point multiplied by the percentage value set on the slider.</p> <p>In the Converge layout, the element moves towards the center point; in the Diverge layout the element moves further away from the center point.</p>

Fan Relations Layout

The Fan Relations layout arranges the immediate relations of an element around a specified edge. This layout requires a single element to be selected on the diagram, to be used as the context for the layout.

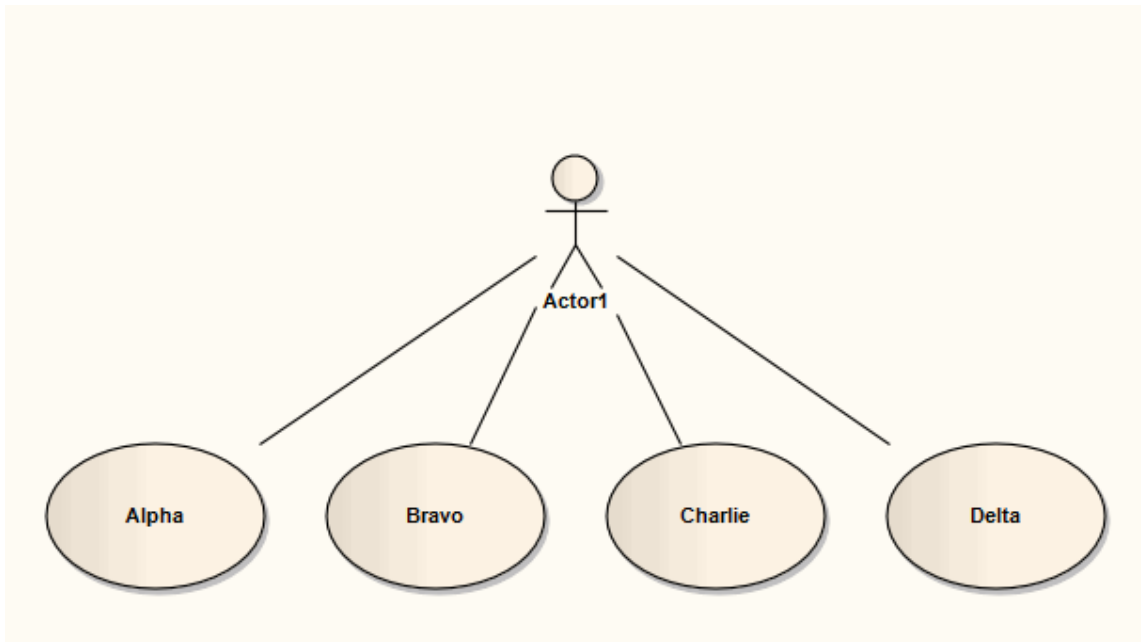

Invoke the Fan Relations layout

Step	Action
1	<p>Open the Layout Tools window; either:</p> <ul style="list-style-type: none">• Select the 'Layout > Tools > Diagram Layout' ribbon option, or• Right-click on the main toolbar and select the 'Diagram Layout Tools' option

2	Select the single element around which to lay out related elements on the currently-active diagram.
3	Click on the drop-down arrow on the top left button of the Layout Tools window, and select Fan 'Relations'.
4	<p>Click on the drop-down arrow in the 'Sort By' field and select the required sort parameter.</p> <p>The options are:</p> <ul style="list-style-type: none">• 'None' - elements are passed to the specified layout in the order in which they appear on the original diagram (left to right, top to bottom)• 'Area (Ascending)' - elements are passed to the specified layout in order of the screen space they occupy, smallest to largest• 'Area (Descending)' - elements are passed to the specified layout in order of the screen space they occupy, largest to smallest• 'Name (Ascending)' - elements are passed to the specified layout in alphanumeric order, based on the element name• 'Name (Descending)' - elements are passed to the specified layout in reverse alphanumeric order, based on the element name• 'Element Type' - elements are grouped by type (for example, Class, Use Case) and in alphanumeric

	order within the group by name
5	In the 'Padding (px)' field, type the separation required between the selected element and its related elements, in pixels.
6	Select the connector direction to use in determining the related elements to lay out; either: <ul style="list-style-type: none">• Incoming Nodes - to lay out related elements that have the selected element as the target• Outgoing Nodes - to lay out related elements that have the selected element as the source
7	In the 'Fan Edge' field, click on the drop-down arrow and specify the edge of the selected element from which to lay out the related elements: <ul style="list-style-type: none">• Left - to arrange related elements to the left of the selected element• Right - to arrange related elements to the right of the selected element• Top - to arrange related elements from the top of the selected element• Bottom - to arrange related elements from the bottom of the selected element

Auto Route Layout

The Auto Route layout orthogonally routes connectors between the selected elements. The layout attempts to find the shortest path between the two connected elements while minimizing crossings. In this illustration, the original connectors are shown in red.

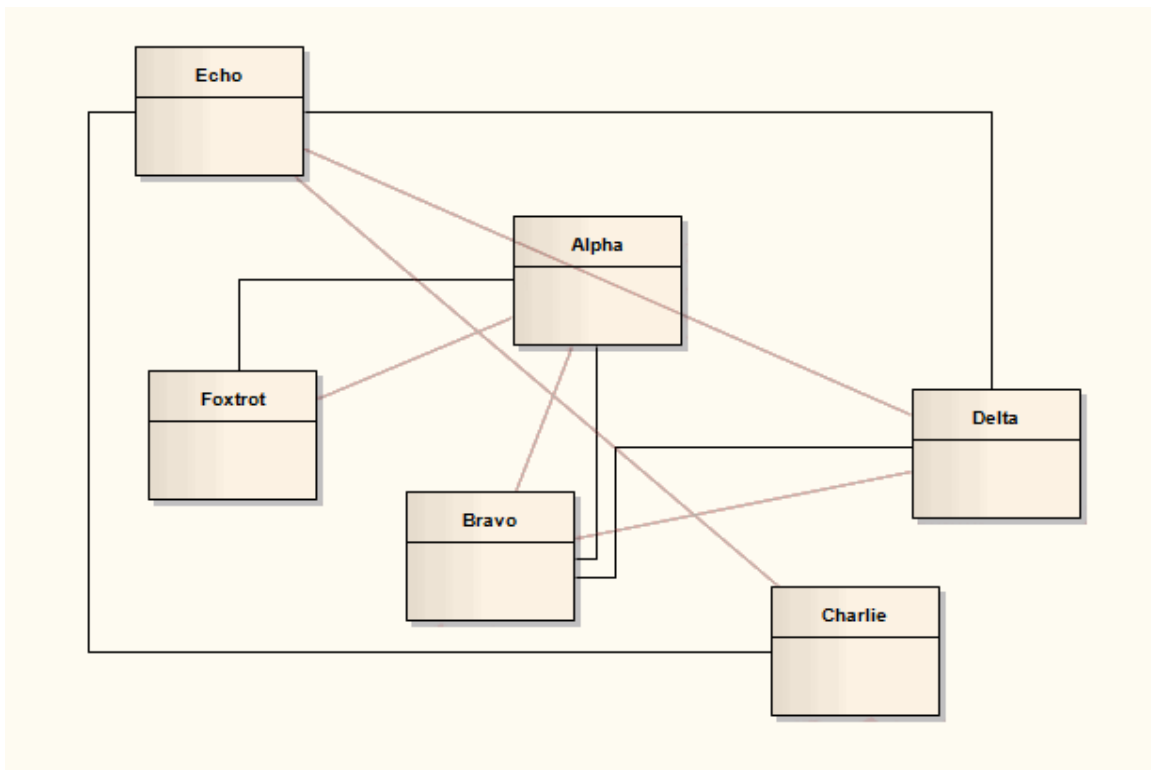

Invoke the Autoroute layout

Step	Action
1	Follow the general <i>Layout Diagrams</i> procedure, and at step 2 select 'Auto Route'.

2	<p>In the 'Cell Size (px)' field, type the effective connector separation in pixels.</p> <p>When calculating connector routes, the algorithm divides the diagram into cells of a size determined by this field value; a smaller cell size results in connectors being placed closer together.</p>
3	<p>In the 'Element Margin' field, type the separation between connector segments and element borders, in pixels.</p>

Lay Out a Diagram Automatically

As you develop a diagram, it can become difficult to position the elements and connectors so that the layout and organization remain clear. Rather than continually moving structures around manually, you can simply select a 'Layout Diagram' option to automatically reposition all the structures on the diagram in a logical, tree-based structure. If your diagram is complex, you can then do some manual 'tweaking' to draw out particular elements and relationships. Generally the default layout parameters provide adequate layouts for a wide range of diagrams, but for a fine degree of control you can also set layout parameters using the 'Diagram Layout Options' dialog.

Access

Ribbon	<p>To configure settings:</p> <ul style="list-style-type: none"> • Design > Diagram > Manage > Properties > Diagram: Set Layout Style or • Layout > Diagram > Options > Properties > Diagram: Set Layout Style (on an open diagram)
Context Menu	<p>To configure settings:</p> <ul style="list-style-type: none"> • Right-click on diagram Properties >

	Diagram: Set Layout Style
Other	<p>To configure settings:</p> <ul style="list-style-type: none"> • Double-click background of diagram > Diagram : Set Layout Style <p>To apply layout:</p> <ul style="list-style-type: none"> • diagram toolbar :  Auto Layout

Apply Layout Configurations

Option	Action
Cycle Remove Options	<p>These settings remove cycles in the element organization (where element X is the source of a path but also becomes the target of a branch of the path), by reversing the connectors that impose the cycling and then reorganizing the diagram and reinstating the reversed relationships; this identifies the primary source element in the diagram. Select:</p> <ul style="list-style-type: none"> • Greedy - to use the Greedy Cycle Removal algorithm, which minimizes the number of connectors reversed • Depth First Search - to use the Depth

	<p>First Search Cycle Removal algorithm, which establishes the longest linear sequence possible before establishing parallel sequences and branches; this algorithm is less effective in large and/or complex diagrams, but produces a more natural layout than the Greedy algorithm</p>
<p>Crossing Reduction Options</p>	<p>These options determine the length of time the routine searches for ways of reorganizing the layout to avoid crossed relationships:</p> <ul style="list-style-type: none"> • Iterations - Type the number of iterations to be used during cycle removal (more than 8 does not usually provide any improvement) • Aggressive - Select this checkbox to use an aggressive (detailed and time-consuming) crossing reduction step
<p>Layering Options</p>	<p>These settings determine how elements are organized in layers during layout. Select:</p> <ul style="list-style-type: none"> • Longest Path Sink - to use the Longest Path Sink Layering algorithm, where the final target elements (sinks, which have no relationships issuing from

	<p>them) are arranged in a layer at the top of the diagram, and the relationship paths built downwards from there in as many layers as there are nodes in the longest path</p> <ul style="list-style-type: none"> • Longest Path Source - to use the Longest Path Source Layering algorithm, where the original source elements (those with no relationships entering them) are arranged in a layer at the bottom of the diagram and the relationship paths built up from there in as many layers as there are nodes in the longest path • Optimal Link Length - to use the Optimal Link Length Layering algorithm, which organizes the elements into the number of layers that minimizes the total source-to-sink relationship chain; in this layout you can have both source elements and sink elements at various levels of the diagram
<p>Layout Options</p>	<p>These settings define how far apart the element layers and columns are in the layout.</p> <ul style="list-style-type: none"> • Layer Spacing - Type the default number of logical units between layers

	<p>of elements (vertical spacing)</p> <ul style="list-style-type: none"> • Column Spacing - Type the default number of logical units between elements within a layer (horizontal spacing)
Initialize Options	<p>The autolayout routine inserts line waypoints and connectors into relationship paths to help plot the direction of the relationships; the routine then assigns an index number to every node, such that nodes in the same layer are numbered left to right. These settings determine how those index numbers are assigned. Select:</p> <ul style="list-style-type: none"> • Naive - to use the Naive Initialize Indices algorithm, which assigns index numbers to nodes as they are encountered in a sweep and tends to place all waypoints to the right of real nodes (and therefore long relationships between a small number of elements to the right of chains of short relationships between several elements) • Depth First Search Outward - to use the Depth First Out Initialize Indices algorithm, which assigns index numbers to nodes as they are encountered in a depth first search from

	<p>source nodes outwards (and would therefore place longer relationship chains to the left of shorter chains, with the primary source node at the start of the diagram flow)</p> <ul style="list-style-type: none"> • Depth First Search Inward - to use the Depth First In Initialize Indices algorithm, which also assigns index numbers to nodes as they are encountered in a depth first search, but from sink nodes inwards (and would therefore place longer relationship chains to the left of shorter chains, with the ultimate target node at the end of the diagram flow)
<p>Direction</p>	<p>Select the direction in which all directed connectors should point, to set the position of the primary source element and the overall flow of the diagram. That is, Up, Down, Left, or Right.</p>
<p>Set as Project Default</p>	<p>Select this checkbox to apply the diagram layout settings to all diagrams in the project.</p> <p>If you later define different settings and select this checkbox, the new settings override all those saved previously.</p>

OK	Click on this button to save your settings.
----	---

Example

This illustration shows an automatically laid out diagram with these options set:

- 'Depth First Search'
- 'Optimal Link Length'
- 'Depth First Search Outward'
- 'Direction - Up'

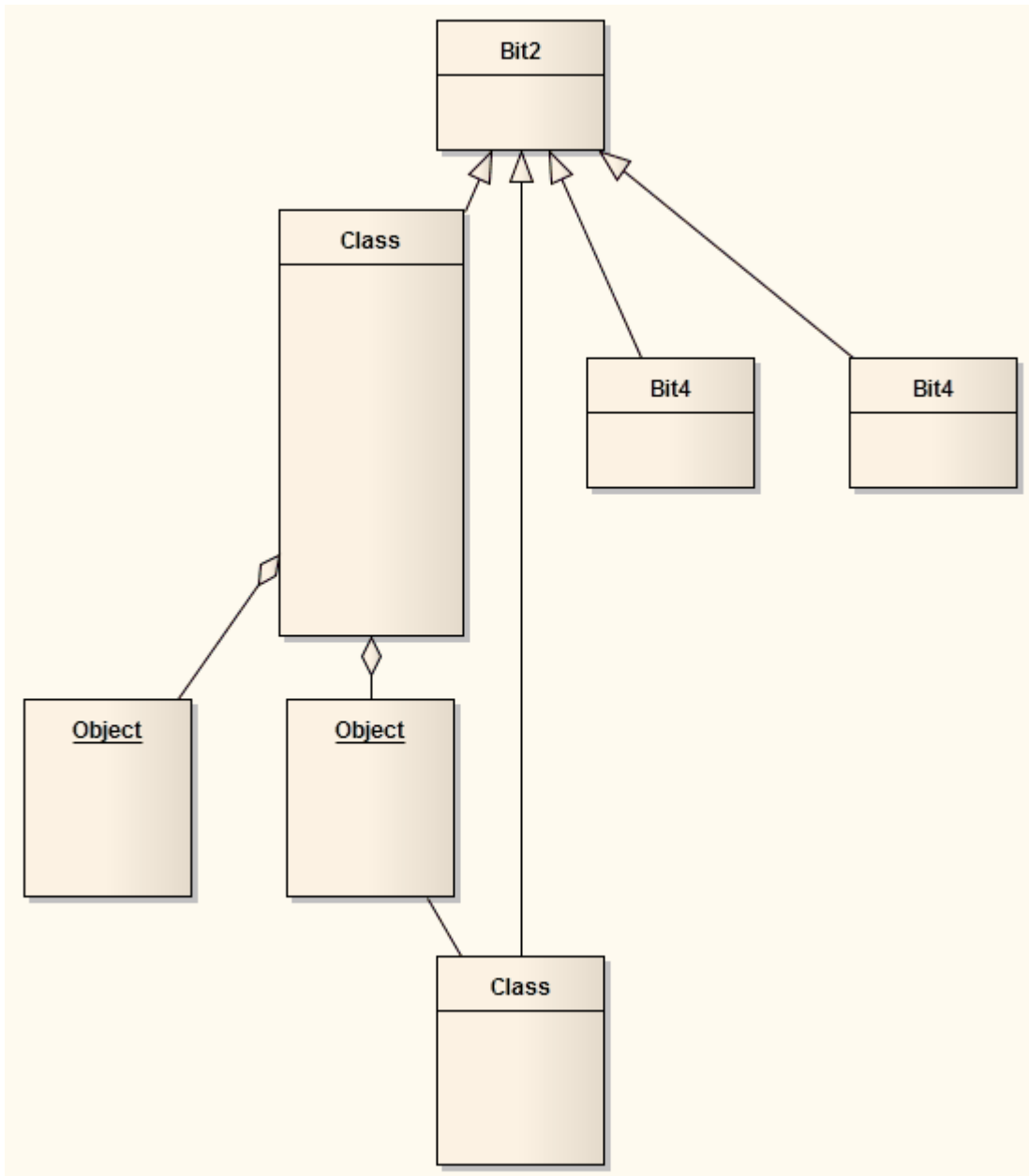

Notes

- This facility is available for all types of diagram other than Timing and Interaction Overview diagrams
- If you decide that the autolayout is not appropriate, you can reverse it before saving the diagram; click **Ctrl+Z**

Chain Diagram Layouts

Each of the diagram layout formats has a specific effect on the layout and appearance of a diagram. These effects can be combined by chaining certain layouts in a sequence, to further improve the final appearance of the diagram.

Enterprise Architect provides a selection of standard 'chains' for your use, and you can quickly and easily set up chains of your own.

The system does not restrict the way in which you combine the layouts, but in practice some layouts complement each other better than others, or are more logically executed in a certain order. You therefore need to consider the effect of each layout on the diagram - or part of the diagram - as you develop the chain. You also provide parameters for each layout, so you would set the parameters for each format to complement those for the other formats in the chain, using the 'Layout Chains' dialog.



The available formats could be grouped by impact on the diagram:

- Circle, Ellipse, Box, Per Page, Digraph and Spring each adjust element positions completely, so would destroy the effects of any other layout if used after it in a chain; one of these would therefore be the first layout to apply in the chain
- Fan Relations operates on a specific element, so you might not want to further adjust the diagram layout; if you did, you would only use these next layouts

- Converge/Diverge could be used after some of the preceding layouts, to broaden or narrow the final layout
- Neaten is a logical successor to the previous types, adjusting positions to provide more uniform separation
- Auto-route is the best final layout, to adjust connectors to the clearest routes without changing element positions

In creating a chain of layouts, you might consider these suggestions in selecting which layouts to use and in which sequence.





Access

Ribbon	Layout > Tools > Diagram Layout > Open Diagram Layout Tools: 
Other	Right-click on any toolbar Diagram Layout Tools: 

Set up a chain

On the 'Layout Chains' dialog:

Step	Action
1	Either:

	<ul style="list-style-type: none">• Click on the New Chain button and type in a new chain name (and click on the OK button) or• Click on the drop-down arrow and select the name of an existing chain to edit <p>If you want to delete the existing chain you have selected, click on the Delete Chain button.</p> <p>If you want to rename the existing chain, click on the  button and overwrite the existing name with the new name (and click on the OK button).</p>
2	<p>In the 'Existing Layouts' field, click on the first layout to execute in the chain, then click on the  button to add it to the chain.</p> <p>Repeat this step to add further layouts to the chain.</p>
3	<p>If you do not want to include a layout that is currently in the chain, click on it and click on the  button.</p> <p>If you want to move a layout in the chain to a different point in the sequence, click on it and click on the  or  button as appropriate.</p>
4	<p>If you want to change the name of a layout, click once on the name in the chain list and overwrite it.</p> <p>To set the parameters of each layout, double-click on the layout name in the chain list. The appropriate parameter dialog for the layout displays; complete the fields as appropriate and click on the OK button.</p>

	<p>These are the parameters that will be applied whenever you execute this layout chain, regardless of the settings in any other use of the layout.</p>
5	<p>Click on the Save Chains button to save your changes, then click on the OK button. (If you have not saved your changes, an error message displays; click on the Yes button.)</p>

Image Assets

Image Assets are model elements that are used to store images in the model.

To create an Image Asset element, simply drag an 'Image Asset' icon onto a diagram from the 'Artifact' page of the Diagram Toolbox. A prompt displays to choose an image file.

Alternatively, you can drag an image file from your file system straight onto a diagram. Enterprise Architect creates a new Image Asset Artifact, then stores the image from the file in the Artifact, as the 'owned image'.

The Image Asset images can then be used as alternative images in place of the standard UML notation for elements on diagrams. They can also be used in documentation by inserting hyperlinks to the Image Asset element. When a report is generated, the hyperlinked Image Asset element is rendered using its 'owned image'.

Access

Diagram Toolbox	Select the 'Common Elements' page select 'Image Asset' click on the diagram, or Drag an 'Image Asset' Artifact from the Toolbox onto a diagram.

Other	Select an image file in your file system (say, on the desktop) then drag and drop it onto a diagram in Enterprise Architect. A context menu will display; select the option 'Image Asset'.
-------	--

Using Image Assets in Documentation

Step	Action
1	<p>While editing the Notes of an element, or editing a Linked Document, and if you have located the Image Asset in the Browser window, you can drag the Image Asset element into the document. The 'Add Content to Document' dialog displays with the 'Insert As' field set to 'Insert as Hyperlink(s)'. Click on the OK button to insert the element as a hyperlink that will be rendered as the image.</p> <p>If you need to search for the Image Asset, go to step 2.</p>
2	<p>Right-click in the document and choose 'Create Hyperlink'. The 'Hyperlink Details' dialog displays.</p> <p>Select 'Element Image' from the drop</p>

	down list. The 'Select Element' dialog displays, showing only Image Assets.
3	Browse through the model and select the required Image Asset.
4	Click on the OK button, and on the second OK button.

Select an Image Asset as an Element's Alternative Image

You can use one of two methods for adding an Image Asset to an element as an alternative image.

Method	Action
1	<ol style="list-style-type: none"> 1. Right-click an element on a diagram and choose the option 'Appearance Select an Image Asset' from the context menu. The 'Select Element' dialog displays, showing only Image Asset elements in Packages. 2. Browse through the model and select the required Image Asset. 3. Click on the OK button.
	<ol style="list-style-type: none"> 1. Display the diagram containing the

2	<p>model element.</p> <ol style="list-style-type: none">2. Locate the Image Asset in the Browser window.3. Drag the Image Asset over the top of the model element.4. Select the 'Set as Alternate Image' option.
---	--

Viewing the Image

When initially placed on the diagram the Image Asset can be rendered either as a simple Artifact element, or as the owned image. The display can be toggled from one to the other, by right-clicking the element and selecting 'Show Owned Image' from the context menu.

When the Image Asset is displayed on a diagram as a UML Artifact element, either:

- Click on the  icon off the right side of the element; the linked image is shown in a floating Diagram Pop-up window - you can pan across large images in the pop-up window by 'click + dragging' the mouse and you can close the window by clicking off the diagram image, or
- Double-click on the Image Asset to launch the default external viewer for images and load the Artifact's owned image

You can also press Ctrl+click on a hyperlink to an Image Asset to display the image in the default external viewer.

When hovering over the hyperlink, the standard hyperlink element buttons will also be displayed, allowing you to display the 'Properties' dialog, find the element in diagrams, find the element in the Browser window, or open the Linked Document attached to the element.

Properties

To display the Properties window for the Image Asset:

- Select the element and press Ctrl+Enter, or
- If the Image Asset is displayed on a diagram as the image, double-click on it, or
- If the Image Asset is referenced by a hyperlink, hover the mouse over the hyperlink to display a floating toolbar and click on the View Properties button

Using the Image Manager

When you add an element to a diagram, it is rendered according to the standard UML notation. However, you can replace that representation with an image. For example, you could add a custom background image to a diagram, or display an image of a Router or PC on a UML element. You import, store and select these alternative images using the Image Manager. You can apply the image either as a:

- Default image, which displays on all instances of the element in diagrams across the model, or
- An alternative image, which displays only for the specific instance of the element to which it is applied, and which overrides the default image for that instance

To locate and display images within the Image Manager, click on individual image filenames, or press the Up arrow and Down arrow keys to scroll through the list of images. As you highlight each image filename, the 'Preview' panel changes to reflect the image. Double-click on the required image filename to display the image in full size.

Another option for displaying an image on a diagram is to simply drag an image file onto a diagram from the operating system file manager. For more details see the *Create File Artifacts* Help topic.

Access

--	--

Ribbon	Settings > Reference Data > Images
Context Menu	Right-click on an element within a diagram Appearance Select Alternate Image or Right-click on an element within a diagram Appearance Select Default Image
Keyboard Shortcuts	Click on an element within a diagram : Ctrl+Shift+W

Image Manager Options

On the Image Manager, these buttons are available:

Button	Action
View	Click on this button to display the selected image in full size. Shortcut: Alt+V
Usage	Click on this button to display the 'Element Usage' dialog, which lists the diagrams in which the selected image is used.
Rename	Click on this button to change the

	<p>filename of the selected image.</p> <p>The option first warns you that the change would impact the other elements that use this image, and prompts you to confirm that you want to go ahead with the name change.</p> <p>If you continue, a prompt displays for you to enter the new filename.</p>
<p>Add New</p>	<p>Click on this button to display options for importing images from a file system or from the clipboard.</p> <ul style="list-style-type: none">• From File - select this option to display a browser through which you can search appropriate directories to locate and import new images You can import images in .bmp, .png, .emf, .wmf, .tga, .pcx or .jpg format• From Clipboard - select this option to download the image from the clipboard into the Image Manager (not via a diagram) <p>Internally, the images are stored in .png or metafile format to conserve space.</p> <p>You can also add images by:</p> <ul style="list-style-type: none">• Importing a library of alternative images from the Sparx Systems website

	<ul style="list-style-type: none"> • Copying the Image Library from another model using the 'Export Reference Data' and 'Import Reference Data' facilities, and • Capturing images from other sources into the clipboard and applying them to an element in a diagram, which automatically adds the image as an autonamed file to the Image Library <p>If necessary, you can change the file name using the 'Rename' option. Shortcut: Alt+A</p>
Update Selected	<p>Click on this button to refresh the selected image; for example, after it has been modified.</p> <p>A browser screen displays for you to select the updated image file from its parent directory. Shortcut: Alt+U</p>
Add Description	<p>Displays the 'Image Description' dialog, in which you enter a title for the image and a brief description to identify any significant facts about the image, such as its purpose, of the version it represents.</p>
Convert to	<p>Displays a message warning that the image will be converted to an Image</p>

Image Asset	<p>Asset Artifact in the currently-selected Package. The image will be removed from the Image Manager and can no longer be applied to another element, but the Image Asset element itself can be added to diagrams and called into documentation via a hyperlink.</p>
Delete	<p>(Not available for an image from a deployed MDG Technology.)</p> <p>Click on this button to delete the selected image.</p> <p>A message displays to indicate how many elements use the image. Click on the Yes button to delete information about the image from those elements, which then revert to their previous appearance.</p> <p>Shortcut: Alt+D</p>
Cancel	<p>Click on this button to close the Image Manager.</p>
OK	<p>Click on this button to confirm selection of the alternative image for the element selected in the diagram.</p> <p>Shortcut: Alt+O</p>

Notes

- If you do not want an element to continue to have a default image or an alternative image, assign it the '--NONE--' option in the image list
- In the Corporate, Unified and Ultimate Editions of Enterprise Architect, if security is enabled you must have 'Configure Images' permission to configure alternative element images
- If you are connected to a SQL Server repository, you require ALTER permission on the t_image table in Enterprise Architect, to be able to import model images
- For elements with Lifelines, such as those used on Sequence diagrams, the Lifeline must remain intact so that messages can be created between the elements; therefore such elements cannot have alternative images
- There are two categories of image available through the Image Manager:
 - Images that have been imported into the model and are stored in the model
 - Images that are incorporated into a deployed MDG Technology, which are not copied into the current model but are held in memory; the technology images can be identified by the Technology name followed by the image file name, such as 'MDGFrame::ovalshape.emf', but can also be accessed by their short form (the name minus the technology name)
- If you are creating many elements of the same type that

have a particular image, you should use a custom stereotype with an associated metafile

- If an element has an image, the element name is likely to be hidden; you can display the name underneath the image by right-clicking on the element and selecting 'Appearance | Show Name Under Image', and hide it again by selecting 'Appearance | Hide Name Under Image'
- You can transport image files between models, using the 'Settings > Model > Transfer > Export Reference Data' and 'Import Reference Data' ribbon options

Create Custom Diagram Background

Enterprise Architect provides a number of options for setting the background of a diagram - a Theme, a system-defined tile background, a single-color flat background or a fading color gradient down the screen.

Alternatively, using the Image Manager, you can create a customized tiled or non-tiled background for your diagrams.

Create a customized background

Step	Action
1	Check that a suitable image is available in the Image Manager. If the image you require is held elsewhere, import the file or the library containing the file.
2	Open a diagram and create a Boundary object from the 'Use Case Elements' page of the Toolbox (do not use the Boundary element from any other section of the Toolbox).
3	Stretch the Boundary to a size that can contain all of the elements you intend to place on the diagram, and drag it to the edges of the diagram workspace.
4	Right-click on the Boundary element and select the

	<p>'Z-Order Send to Bottom' option.</p> <p>This places the Boundary behind all other elements on the diagram.</p>
5	<p>Either:</p> <ul style="list-style-type: none">• Press Ctrl+Shift+W, or• Right-click on the Boundary and select the 'Appearance Alternate Image' option
6	<p>On the Image Manager window, select the required image for the diagram background and check that the image size is large enough to span the required size of the diagram background.</p>
7	<p>Click on the OK button.</p>

Notes

- As an alternative method: after you have added the Boundary element to the diagram, copy an image from another source onto the Windows clipboard, right-click on the Boundary element, and select the 'Appearance | Apply Image From Clipboard' option

Import Image Library

Using the Image Manager, you can create attractive diagrams with custom images. You can quickly extend the range of images available through the Image Manager, by importing a bundled clip art collection of UML-based images as an Image Library file downloaded from the Sparx Systems website.

Import the Image Library file

Step	Action
1	Download the Image Library from the Sparx Systems website onto your system.
2	In Enterprise Architect, open the project into which to import the Image Library.
3	Select the ribbon option 'Settings > Model > Transfer > Import Reference Data'. The 'Import Reference Data' dialog displays.
4	Click on the Select File button and locate the ImageLibrary.xml file to import, in the directory to which you downloaded the file. Click on the Open button.

5	<p>On the 'Import Reference Data' dialog, select the 'Model Images' data set that now contains the Image Library.</p> <p>Click on the Import button and, when the import is complete, the OK button.</p>
---	--

Use the images contained within the Image Library

Step	Action
1	Create and/or open a diagram in which to use images from the Image Library.
2	Click on the element to which to apply one of the images contained within the library.
3	<p>Either:</p> <ul style="list-style-type: none"> • Press Ctrl+Shift+W, or • Right-click on the selected element and select the 'Appearance Select Alternate Image' option
4	On the 'Image Manager' dialog, in the 'Loaded Images' panel, click on the appropriate image name

and then on the OK button.

The element appearance changes to the selected image.

Notes

- Images contained within the Image Library are the copyright of Sparx Systems, are only available for use in conjunction with Enterprise Architect, and are supplied on the understanding that they are not used under any other circumstances
- If you are connected to a SQL Server repository, you require ALTER permission on the t_image table in Enterprise Architect, to be able to import model images

Diagram List

The Diagram List is a tabular, editable view of elements in a selected diagram, which can be displayed in the main workspace. You can use the Diagram List to:

- Streamline the process of creating and updating elements in a diagram selected from the Browser window; this can be particularly useful for analysts to create and maintain formal requirement definitions within the model
- Print the list or generate a document report directly from the entries on the list



Access

Ribbon	Design > Diagram > Views > List View
Context Menu	Right-click on diagram background Switch View Switch to List View or Right-click on diagram tab Switch to List View
Keyboard Shortcuts	Ctrl+Alt+R (opens a new view, as a list)

Aspects

Aspect	Description
The Diagram List	The Diagram List is related to the Package Browser, which lists the elements in a selected Package; however, the Package Browser has a wider range of options.
Formats	The Diagram List is displayed in 'User Defined' format, where you can change how the element information is structured on the screen using the value-grouping band below the toolbar.
Change display	<ul style="list-style-type: none"> • Sort the items by any column value in ascending or descending order, by clicking on the column header; initially the elements are listed in numerical order (if level numbering is turned on in the Browser window) or alphabetical order within type • Apply a diagram filter for elements (the Fade, Gray Scale and Hide modes reduce the number of elements listed; Select mode has no effect) • Change the sequence of columns, by dragging column headers left or right

Display Element Properties	Double-click on the element entry.
Select Items	Select: <ul style="list-style-type: none">• an element by clicking on it• a specific value by clicking twice on it (not double-clicking); either the value becomes directly editable or the 'Properties' dialog displays in which you can edit the value• several individual elements by holding Ctrl as you click on them• a range of elements by holding Shift as you click on the first and last in the range
Add new items to the diagram	Create new elements on the Diagram List, using the toolbar or context menu options; these elements are automatically added to the diagram.
Delete elements from the list	Select the item and press Ctrl+D.
Include each element's notes	Notes are shown underneath the element. To add or edit notes, click on the item

(documentation)	and press Ctrl+Space to transfer control to the Quick Notes window, in which you create or edit the note text.
Review the element's custom (advanced) properties	Right-click on the item and select the 'Properties' option, then select the 'Advanced' page.
Further Options	<p>You can do further work on the Diagram List using the same toolbar and context menu options as for the Package Browser, except that the Diagram List does not have:</p> <ul style="list-style-type: none">• The Model Hierarchy format and hence does not have the  button in the toolbar• The  toggle button• The  toggle button <p>The Diagram List does have these additional context menu options:</p> <ul style="list-style-type: none">• Switch to Diagram View - show the elements of the selected diagram in graphical format instead of as the Diagram List• Switch to View as Gantt - list the diagram elements as bars of a Gantt

chart, representing the elements' resource allocations

- Switch to Specification Manager - list the diagram elements with their notes and various other properties in the Specification Manager
- Switch to Traceability View - list the elements on the diagram as entries in the Traceability window, which you can expand to show the connectors and related elements of each element on the diagram
- Diagram Properties - display the 'Properties' dialog for the diagram

Alternative Views of Diagram Content

By default, a diagram always opens in graphical view. Enterprise Architect supports several alternative ways of viewing the content of the diagram after it has been opened. From the graphical view, you can switch the diagram content to display in:

- List view
- Gantt view
- Specification view
- Relation Matrix view or
- Construct view

It is also possible to change the default view on opening of a specific diagram, to List View, Specification View or Gantt View, through the diagram's 'Properties' dialog.

Access

You can switch an open diagram to an alternative view using any of these methods:

Ribbon	Design > Diagram > Views > <type> View
Context menu	Right-click on diagram background Switch View Switch to <type> View or Right-click on diagram tab Switch to

	<p><i><type></i> View</p> <p>In Browser window, right-click on the diagram name Switch View Switch to <i><type></i> View</p>
Properties window	<p>Diagram > Appearance > Display As : Select <i><type></i> from drop down.</p>

Diagram View Types

View Type	Description
Graphical View	<p>The traditional view of a diagram. Model elements are depicted as shapes, with relationships between elements represented as lines drawn between the elements. New elements and connectors can be created by dragging the appropriate type from the Diagram Toolbox onto the diagram.</p> <p>After you switch from the graphical view to another view, you can immediately return to the graphical view by clicking on the black back-arrow in the diagram name tab, even if you have worked through a chain of views.</p>

List View	The Diagram List is a tabular, editable view of elements in a selected diagram. It can be used to streamline the process of creating and updating elements in a diagram.
Gantt View	The Gantt view presents the elements of the selected diagram, in the form of a Gantt Chart. This allows you to review the allocation of work to elements in just the selected diagram, focusing on either the elements that require work or the resources required to perform the work.
Specification View	The Specification View displays the contents of the selected diagram, in the form of a document. It is ideal for creating and updating Requirements elements, or any elements that involve extended textual descriptions.
Relation Matrix View	The Relation Matrix view is a grid that identifies the relationships between the diagram elements. There is both a row and a column corresponding to each diagram element - the cell at the intersection of a row and a column shows the relationship details between the corresponding diagram elements. This

	<p>view provides a means to quickly find elements that are not yet connected to other elements, such as Requirements that are not yet realized. You can also create new relationships directly in the matrix.</p>
Construct View	<p>The Construct View is an aid to Project Management, that facilitates easy review of the Resources and Maintenance items associated with elements appearing on the selected diagram. You can filter the view to show resources, or a single category or all categories of Maintenance items.</p>

Learn more

- [Diagram View](#) (check Inline Specification)
- [Diagram Properties - Detail](#)

–

User and Model Default Diagrams

As you develop your model, you might create a central diagram that represents the current area of work or the direction of development, with hyperlinks to other diagrams and resources, thus creating a Home Page for your model. You could set this diagram to open automatically when you access the model at the start of a work session. You have two options for configuring such a diagram:

- As your user default, so that the diagram opens when you (or, if appropriate, members of your log-in group) access the model but not when any other user opens the model
- As your model default, so that the diagram opens when any user opens the model

You can have separate diagrams defined as a user default and as a model default, in which case the user default diagram takes precedence and is the diagram that opens automatically. However, both diagrams are overridden by any project shortcut that defines displays to present on opening the model.

The options to set default diagrams are available in the Corporate, Unified and Ultimate Editions of Enterprise Architect; User Security must be enabled and you must have 'Manage Project Settings' permission to set a diagram as a user or model default.

Set User Default Diagram

Make the current diagram the default diagram displayed

when you re-open this model.

- Start > Personal > My Diagram > Manage > Set Current as Default (if the required diagram is open and active)
- Start > Personal > My Diagram > Manage > Choose Default (to browse for the required diagram)

Once you select this diagram, it will display automatically when you open the model.

Set Model Default Diagram

Make the current diagram the default diagram displayed when any user re-opens this model.

- Start > Collaborate > Model Diagram > Manage > Set Current as Default (if the required diagram is open and active)
- Start > Collaborate > Model Diagram > Manage > Choose Default (to browse for the required diagram)

Once you select this diagram, it will display automatically when any user opens the model.

Managing Default Diagrams

If you have closed a default diagram and want to return to it, use one of these options:

- Start > Personal > My Diagram > Open My Diagram
- Start > Collaborate > Model Diagram > Open Model Diagram

- In the Diagram Status Bar, click on the drop-down arrow on the right and select the 'User Default Diagram' or 'Model Default Diagram' option as appropriate, or

If you want to change either the user default diagram or the model default diagram, use the 'Set' options as described previously, and select a different diagram.

If you want to clear a default diagram, so that you no longer have a default, select one or both of these options:

- Start > Personal > My Diagram > Manage > Clear
- Start > Collaborate > Model Diagram > Manage > Clear

Print Diagram

The 'Print Diagram' facility allows you to print any open model diagram to any available printer.

Firstly, open the diagram in the main work area, then choose the 'Print Diagram' command. The 'Print' dialog is displayed. Use the dialog to select a suitable printer, specify printer settings and choose the number of print copies you require. Click 'OK' to print the diagram.

Access

The 'Print Diagram' command is available for the currently open diagram.

Ribbon	Publish > Diagram Image > Print > Print
Window Selector	Publish > Report Generator > Print Diagram "Alt+6": Report Generator > Print Diagram

Learn more

- [Print Preview](#)

–





Print Preview

Before you print an Enterprise Architect diagram or document, you can display a preview of its output appearance.

Access

Ribbon	 > Print Preview Publish > Diagram Image > Print > Preview Document-Edit > File > Print Preview
--------	--

Notes

- The display initially shows the first two pages on one screen, with no scroll bar
- To toggle between the two-page display and a single-page display, click on the  button in the preview screen toolbar; in either mode, you can use the  and  buttons in the toolbar to scroll through the pages of the diagram or document
- To display more than two pages on one screen, up to a maximum of ten pages, click on the  button in the Preview screen toolbar; the screen now includes the

vertical scroll bar, which you can also use to scroll through the pages of the diagram

- Having checked the preview, you can immediately print the diagram or document by clicking on the  Print button; otherwise click on the Close button

Model Elements



Elements are the building blocks of models and, together with Connectors, they help a modeler to describe an enterprise, business engineering, real-time or software system. They can be found in the Browser window and will typically appear on one or more diagrams, where a modeler will describe what role they play in the model. They also appear in a wide range of dialog windows that show other aspects of the elements, such as testing and resource allocation.

The element types are defined by the modeling languages or profiles they belong to; for example, Classes and Use Cases are part of the grammar of UML, Activities and Gateways are part of the grammar of BPMN, and Blocks and Requirements are part of the grammar of SysML. Each element type has a notation that helps modelers recognize the element and understand its purpose.

In a diagram, when you create or select an element, a small toolbar of options also displays off the top right corner of the element. The first of these is the Quick Linker arrow for creating connectors and target elements, and the others are Element Icons for performing specific operations on the element's appearance in the diagram.

Elements typically have a name, description and a series of

properties and features that describe them, including project properties such as status, phase and author.

Element Facilities

Enterprise Architect provides a wide range of facilities for creating, editing and working with the elements that represent aspects of your models.

Facilities

Facility	Description
Create Elements	Creating elements is extremely versatile. You can create entirely new elements or elements derived from existing ones, on diagrams or directly into Packages, from the standard system-provided definitions or from your own definitions in templates, Patterns or MDG Technologies.
Customize Elements	If the standard elements provided do not serve the purposes of your model, you can give some elements different appearances and/or define a set of properties for them, or create completely new types of element, and use these as the bases for creating the elements in your model.

Name Elements	As you create an element, you can either provide the name yourself, manually, or leave it for the system to provide from a simple standard or a more advanced automatic naming and numbering system set up by your department.
Set Element Parents	Once you have created an element, you can assign it to a parent element or to an interface that it realizes.
Trace Element Use	As you develop your models and use elements in several diagrams to represent different views of the model, you can track and list where the element is in use.
Move Elements	<p>You can easily move individual elements or element structures around the model to other Packages and/or diagrams, either changing the parent Package or diagram, or duplicating the elements in another Package or diagram.</p> <p>You also have a number of different ways in which to change the position of an element or a group of elements within a diagram, either in relation to the diagram or in relation to each other.</p>
Cross	It is possible to set up a cross reference

Referencing Elements	(or Custom Reference) from one element in Enterprise Architect to another. You can also view existing cross references on an element, using the 'Context References' dialog or the Traceability window.
Change Element Type	Sometimes, you might find that an object that you have represented as one type of element would be better represented as another type. You can change the type very quickly and simply.
Delete Elements	Elements can be created in error, or used on the wrong diagrams, or have a temporary function that becomes redundant. In such case you can easily and safely delete the elements from the diagram only or from both the diagram and the model.
Change Element Visibility	Some elements are not shown in Packages and in report documents, by default. These include Events, Decisions, Sequence elements and Associations. You have the option of making these elements visible in the documentation.
Write	One aspect of modeling is to describe and

<p>External Descriptions for Elements</p>	<p>document the purpose and use of an element in the context of a particular diagram. You can provide such documentation in the form of Note or Text elements displayed with and connected to the elements they describe. The Note text can be extra to anything contained within the element, or can expose the internal description of a feature or property of the element.</p>
<p>Customize Element Appearance</p>	<p>You can set a number of standard default features that are applied globally to all elements, but you can also define a different default appearance for one element wherever it might be used.</p>
<p>Set Context Element</p>	<p>Sometimes, when you are working on a diagram, you might want to identify the element against which you are comparing or standardizing some or all of the other elements on the diagram. You can highlight the selected element as the context element.</p>
<p>Use Element Multiple Times</p>	<p>When you are using an element in more than one diagram, you can either create a representation of the element linked to the original, or a copy of the element as a</p>

	separate object. If you create a link, you can subsequently convert it to a separate object.
Reuse Element Features	Many types of element have Features (attributes and operations) that define the properties and actions of the element. You can duplicate selected Features of one element in another, or take a Feature out of one element and place it in another.

Notes

- In the Corporate, Unified and Ultimate Editions of Enterprise Architect, if security is enabled you must have 'Update Element' permission to update element properties or delete an element
- If you select an element in a diagram, you can press the T key to display the Test Cases window for that element

Create Elements

Enterprise Architect provides a number of ways to create completely new elements and those derived from existing elements. The simplest of the methods for creating a new element is to drag the icon for the required type of element from the Diagram Toolbox onto a diagram, as shown.

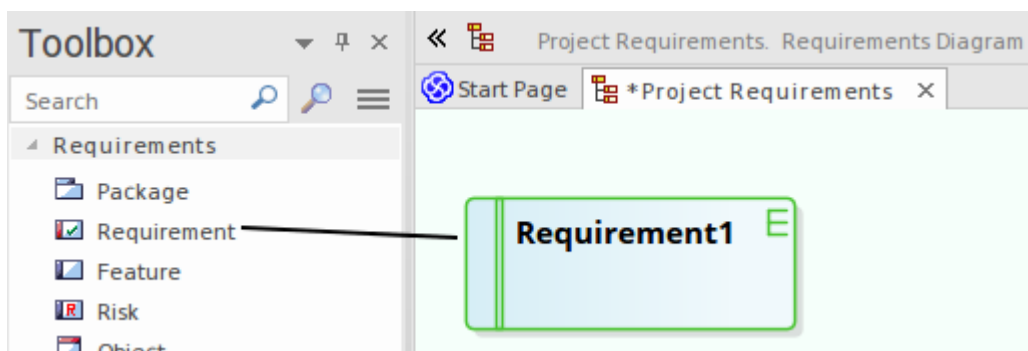

This method creates the element according to the system standard for that element type. You can also provide alternative element definitions that the Toolbox icons reference (using the system 'Preferences' dialog, Patterns or element Templates) and add further element definitions using Profiles and MDG Technologies (either supplied with the system or developed by your project team).

Notes

- A quick way to apply the main facilities of the Toolbox is to press the Spacebar key or Insert key, displaying the 'Toolbox Shortcut' menu; using the mouse, you can also display this menu by holding the left button and clicking the right button
- If you are creating several elements of one type, after

creating the first just press Shift+F3 or Ctrl+click to create the next element of that type

- Once you have created an element, you can re-use it by dragging it from the Browser window and dropping it onto your diagrams
- Sometimes it is useful to add elements directly to a Package, without adding them to a diagram; you can do this within the Browser window

Add Elements Directly To Packages

You can quickly add new elements to a Package without necessarily adding the element to a diagram at the same time. This is particularly useful in defining a group of Requirements, Changes, Issues, base Classes or other element types that you might not need to represent on diagrams in the model.

The fastest and simplest method is to just select an existing element and then press **Ctrl+Shift+N** to create another element of the same type in the same location, enabling you to create several elements in quick succession. In that case you would subsequently use the Properties window or 'Properties' dialog to enter the element names and any other required details.

The other methods described here display the 'New Element' dialog, on which you specify the element name and other details to create identified elements individually. In this case you also have the option of adding the element to the current open diagram.

Access

Ribbon	Design > Element > Add Element > Element
Context	Right-click on Package Add Element

Menu	
Keyboard Shortcuts	<p>In the Browser window, with an element selected: Ctrl+Shift+N (to create another element of the same type in the same location)</p> <p>With a Package selected in the Browser window: Ctrl+M</p> <p>In a diagram, press the M key</p>
Other	Browser window header bar menu New Element

Add an Element to a Package

Option	Action
Toolset	<p>In the first field, click on the drop-down arrow and select a Perspective to filter the types of element offered for selection to those available through the Perspective.</p> <p>Note that selecting a Perspective from the 'Toolset' field list does not change the current 'global' Perspective shown in the  <perspective name> icon. If you want to re-set the 'Toolset' Perspective to the global Perspective, simply click on the</p>

	<p>drop-down arrow and select 'Active'.</p> <p>In the second field, click on the drop-down arrow and select the UML diagram type, Profile, Add-In or MDG Technology to further filter the element types to that diagram type, technology, Profile or Add-In within the Perspective.</p>
Name	Type the name of the element.
Auto	<p>As an alternative to typing in the name, click on this button to insert predefined auto-counter text.</p> <p>If you already have some text in the 'Name' field, it is over-written by the auto-counter text.</p>
Type	<p>Click on the drop-down arrow and select the required element type from the list.</p> <p>The list of element types is derived from the diagram or technology shown in the 'Toolset' field.</p>
Stereotype	<p>If required, either type the stereotype name or click on the drop-down arrow and select the stereotype.</p> <p>This field is not available if the element you are creating is an extended element</p>

	<p>that already has a stereotype.</p>
Add Element to Diagram	<p>This checkbox is available if you have a diagram open and you are working from the Browser window.</p> <p>The checkbox defaults to selected to add the new element to the diagram also; if you do not want the element in that diagram, deselect the checkbox.</p> <p>If you accessed this dialog by pressing the M key on the open diagram, this checkbox is not available. The element is automatically added to the diagram, in the center.</p>
Show Name Under Image	<p>This checkbox is available if you have a diagram open and you have dragged an Image Artifact element onto the diagram from the Browser window. It defaults to selected to print the element name underneath the image shown in the Artifact element. If you clear the checkbox, the element name is not shown.</p>
Save	<p>Click on this button to create the element and close the dialog.</p> <p>If you accessed this dialog by pressing the M key in an open diagram:</p>

	<ul style="list-style-type: none">• the element is created in the center of the diagram, and• the dialog remains open <p>If you accessed the dialog by selecting the 'New Element' option from the Browser window header bar ('Hamburger' icon), clicking on this button also leaves the dialog open.</p>
Save and Close	<p>Available if you have accessed this dialog by pressing the M key on an open diagram, or by selecting the 'New Element' option from the Browser window header bar ('Hamburger' icon). Click on this button to create the element and close the dialog.</p>
Cancel	<p>Click on this button to abort the changes and close the dialog without creating an element.</p>

Notes

- The 'New Element' dialog also displays when you create an element in the Specification Manager, if the Specification Type is <Any>

Auto Names and Counters

When you create a new element in your model, you have different options for naming the element depending on how you are creating it. If you create the element:

- On a diagram, the system applies a default naming convention of the element type plus the increment of the number of elements of that type in the same Package - for example, Actor4; you can change this to any other name by editing the 'Name' field on the element's 'Properties' dialog
- Within the Browser window, the system prompts you to type the element name into the 'New Element' dialog

You can also set up your own, automatic, naming and numbering convention for elements of the same type, so that:

- On a diagram, it is your naming/numbering convention that is automatically applied to the new element (which you can still change if you need to, as before)
- Within the Browser window, the 'New Element' dialog Auto button applies the naming convention to your new element

This is an example of the Auto Name Counter window showing an example name and counter for new Requirements.

The screenshot shows the 'Auto Name Counters' dialog box. The 'Type' dropdown is set to 'Requirement'. In the 'Optional' section, the 'Stereotype' field is empty. In the 'Name' section, the 'Prefix' is 'REQ', the 'Counter' is '00371', and the 'Suffix' is '-'. The 'Apply on creation' checkbox is checked. In the 'Alias' section, all fields are empty, and the 'Apply on creation' checkbox is unchecked. The bottom buttons are 'Save', 'Save & Close', 'Close', and 'Help'.

If you have existing elements in a Package, and you want to apply the new naming convention to them, you can make this change very easily to all elements of the same type in the Package at once.

You define a naming convention for the element type as a model setting. At the same time, you can also optionally define a naming/numbering convention for the 'Alias' field and/or for a stereotype for elements of that type.

Access

Ribbon	Settings > Reference Data > Settings >
--------	--

	Auto Names and Counters
--	-------------------------

Set up Auto Naming for an Element Type

Option	Action
Type	Click on the drop-down arrow and select the element type to which to apply auto naming/auto numbering.
Stereotype	<p>If you want to apply the naming convention to a particular stereotype of the element type, click on the  button to the right of the field, and locate and select the stereotype name using the Stereotype Selector dialog.</p> <p>Note that you can apply one naming convention to the base element type (such as a Class) and a different naming convention to a stereotype of that element (such as a SysML Block).</p>
Name Prefix	Type a prefix for the new names (optional).
Name Counter	Type the counter value; use as many 0's as required to pad the number.

Name Suffix	Type a suffix for the new names (optional).
Name Apply on creation	<p>Select the checkbox to apply auto naming to each new element of the specified type, on creation.</p> <p>If you do not select the checkbox (but click on Save), the autonaming details for the specified element type remain defined in the dialog, but are not applied to new elements of that type. The default element naming convention takes effect (<element type><n>).</p>
Alias Prefix	Type a prefix for the new Aliases (optional).
Alias Counter	Type the counter value; use as many 0's as required to pad the number.
Alias Suffix	Type a suffix for the new Aliases (optional).
Alias Apply on creation	<p>Select the checkbox to apply Alias auto naming to each new element of the specified type, on creation.</p> <p>If you do not select the checkbox (but click on the Save button), the Alias</p>

	<p>autonaming details for the specified element type remain defined in the dialog, but are not applied to new elements of that type. The default element naming convention takes effect (<element type><n>).</p>
Save	<p>(The default highlighted button.) Click on this button to preserve the values you have entered, and leave the dialog open for further changes.</p> <p>New elements of this type now have an automatically-generated name and/or Alias with an incrementing counter value.</p> <ul style="list-style-type: none">• If the user creates an element on a diagram, such as from the Diagram Toolbox or Quick Linker, the element is automatically assigned the defined name and/or Alias• If the user creates an element outside a diagram (such as in the Browser window) using the 'New Element' dialog, they can click on the Auto button next to the 'Name' and/or 'Alias' field on the appropriate dialog to apply the auto-generated text• If the user already has some text in the 'Name' or 'Alias' field, it is over-written by the auto-counter text

	If an Alias is active, to view the Alias in a diagram requires that the option 'Use Alias if Available' is selected in the 'Properties' dialog for the diagram.
Save & Close	Click on this button to preserve the values you have entered, and close the dialog. The button has the same effects on element names as the Save button.
Close	Click on this button to close the dialog and cancel the values you have entered, leaving element auto-naming unchanged.

Notes

- Automatic numbering - whether system default or user-defined - does not increment across Package levels; if you have an element called Actor1 in Package A, and you create an Actor element in a child Package of Package A, that Actor will also be Actor1

Apply Auto Naming to Existing Elements

If you have set up auto-naming conventions for the names and/or Aliases of specific types of element, you can apply those conventions to all of the existing elements of those types in a selected Package, in one operation.

You apply auto-naming through the 'Apply Auto Naming to Elements' dialog. This groups the elements that have auto-naming conventions by type, and shows the effects of applying the conventions to the element names and/or Aliases and stereotypes. You can change all the element names in the Package, or select only certain elements to update.

Access

Ribbon	Click on Package: Design > Package > Manage > Auto Naming
--------	---

Apply Auto-naming to Elements

Option	Action
Current	Initially displays a contracted group for

Name	<p>each element type that has auto-naming conventions, showing the number of elements of that type in the selected Package.</p> <p>Click on the expansion arrow to expand the type group and list the elements within it by their current name, with the most recently created element first.</p> <p>Select the checkbox against each element to be renamed, or against the group name to select all elements in the group. Deselect the checkbox to leave the element name and Alias at their current values.</p>
Name Preview	<p>Initially shows the current name of each element.</p> <p>When you select the checkbox against an element, the name changes to show the effect of applying the auto-naming conventions to it.</p>
Alias Preview	<p>Initially shows the current Alias of each element.</p> <p>When you select the checkbox against an element, the Alias changes to show the effect of applying the auto-naming conventions to it.</p>

All	Click on this button to select all elements listed on the dialog.
Clear	Click on this button to clear the checkboxes of all selected elements.
Update Name Panel	
Prefix Auto Name to Current Name	Click on this radio button to set the new element names to the auto-name text followed by the current name. That is, of this structure: MyPrefix00001MySuffix Original Name
Overwrite current Name with Auto Name	Click on this radio button to set the new element names to the auto-name text only. That is, of this structure: MyPrefix00001MySuffix
Move current Name to Notes Apply Auto Name	Click on this radio button to show the current name in the 'Notes' field in the element 'Properties' dialog (in front of any existing notes) and overwrite the element 'Name' field with the auto-name.
No change	Click on this radio button to leave the current names unchanged. That is, review

	what the auto-naming would look like but do not apply it.
Update Alias Panel	
Prefix Auto Alias to Current Alias	Click on this radio button to set the new element Aliases to the auto-Alias text followed by the current Alias. That is, of this structure: MyPrefix00001MySuffix Original Alias
Overwrite current Alias with Auto Alias	Click on this radio button to set the new element Aliases to the auto-Alias text only. That is, of this structure: MyPrefix00001MySuffix
Move current Alias to Notes Apply Auto Alias	Click on this radio button to show the current Alias in the 'Notes' field in the element 'Properties' dialog (after any replaced element name text, but in front of any existing notes) and overwrite the 'Alias' field with the auto-Alias.
No change	Click on this radio button to leave the current Aliases unchanged. That is, review what the auto-Aliases would look like but do not apply them.

Include sub packages	Select this checkbox to include elements in sub-Packages in this run of applying auto-naming (the checkbox reverts to deselected when the dialog is closed).
Configure Auto Naming	<p>Click on this button to immediately define automatic naming conventions for an element type if:</p> <ul style="list-style-type: none">• You want to change the conventions for the element type, or• The element type that you want to apply auto-naming to has no conventions (and is therefore not listed on the dialog) <p>The 'Auto Name Counters' dialog displays, on which you define your automatic element and/or Alias naming convention. When you click on the Save button on that dialog, any elements of that type in the Package are listed on the 'Apply Auto Naming to Elements' dialog.</p>
OK	Click on this button to close the dialog and put the naming changes into effect.
Cancel	Click on this button to close the dialog and cancel any naming changes you have defined.

Notes

- If you select this facility and there have never been any auto-naming conventions defined in the model, the message *There are no configured auto naming elements contained in the selected package* is displayed; click on the Configure Auto Naming button to define any conventions for any element type you need
- The contents of Packages that are locked under Version Control will not be auto-named
- Because you are applying auto-naming to existing elements, the auto-naming set up 'Apply on Creation' setting has no impact on this operation
- The 'Apply Auto Naming to Elements' dialog is resizable; if you want to expand or reduce the dialog, drag its edges to the size you want

Set Up Templates Package

In building up a model, you might want to represent or emphasize certain characteristics of elements in the appearance of those elements on a diagram, or select particular display options as standard. For example, you could make new Interface elements a different default color to new Class elements, ensure all new Activity Partitions are vertical rather than horizontal, or set a specific group of display options for new Use Case diagrams.

To do this, you create an element or a diagram with all the characteristics you require, and store it in a Templates Package; the system then checks this Package:

- Whenever you create a new diagram, or
- Whenever you start to create an element using the Diagram Toolbox

When you are creating a new diagram, the system checks for the diagram type in the Templates Package and, if it finds that diagram type, will copy the display options of the template diagram into the new diagram.

When you are creating a new element, the system checks for that element type in the Templates Package and, if it finds that element type, will copy the template element as defined. The definition includes any default display options of the template element, so you can apply the template definition and switch to the default appearance for the new element, if you prefer.

In this image, a 'Class' element has been dropped onto the

diagram in the Templates Package. It is created with the default appearance of the base element.

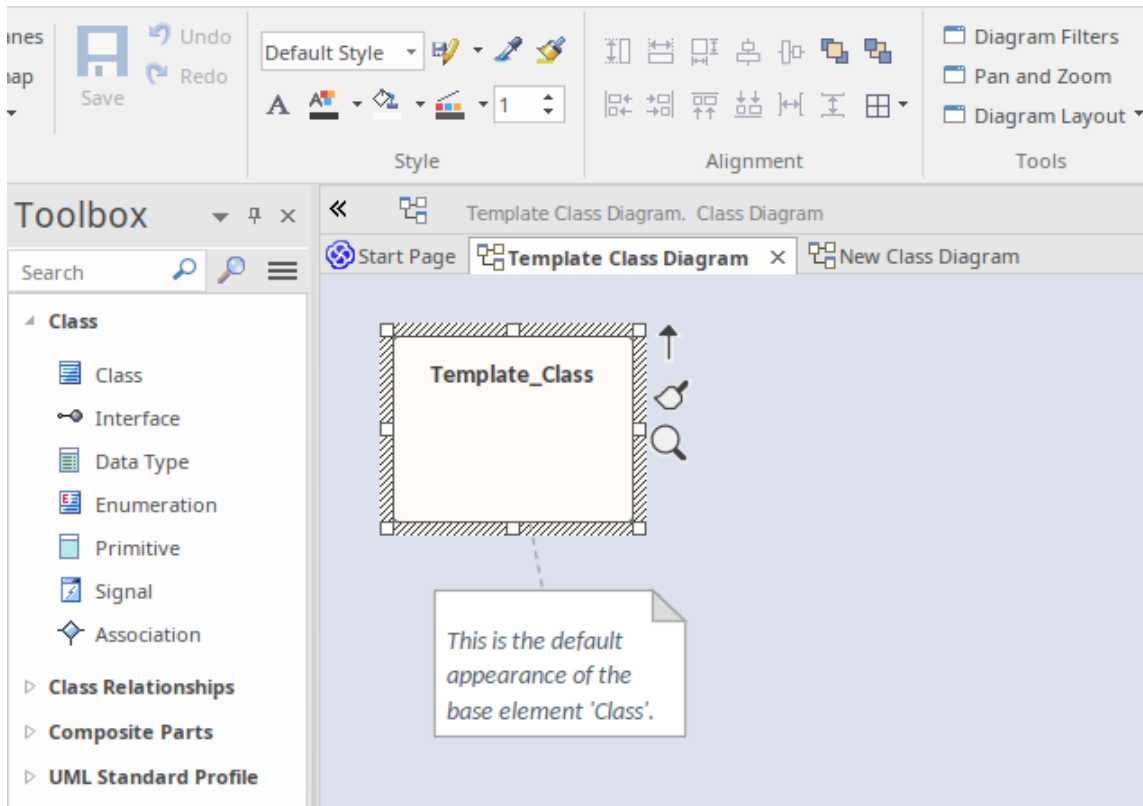

In the next image, the appearance of the element 'Template_Class' on the diagram 'Template Class Diagram' has been updated, using the tools from the Style panel of the Layout ribbon. Note however, that the *default* appearance of the element 'Template_Class' remains unchanged.

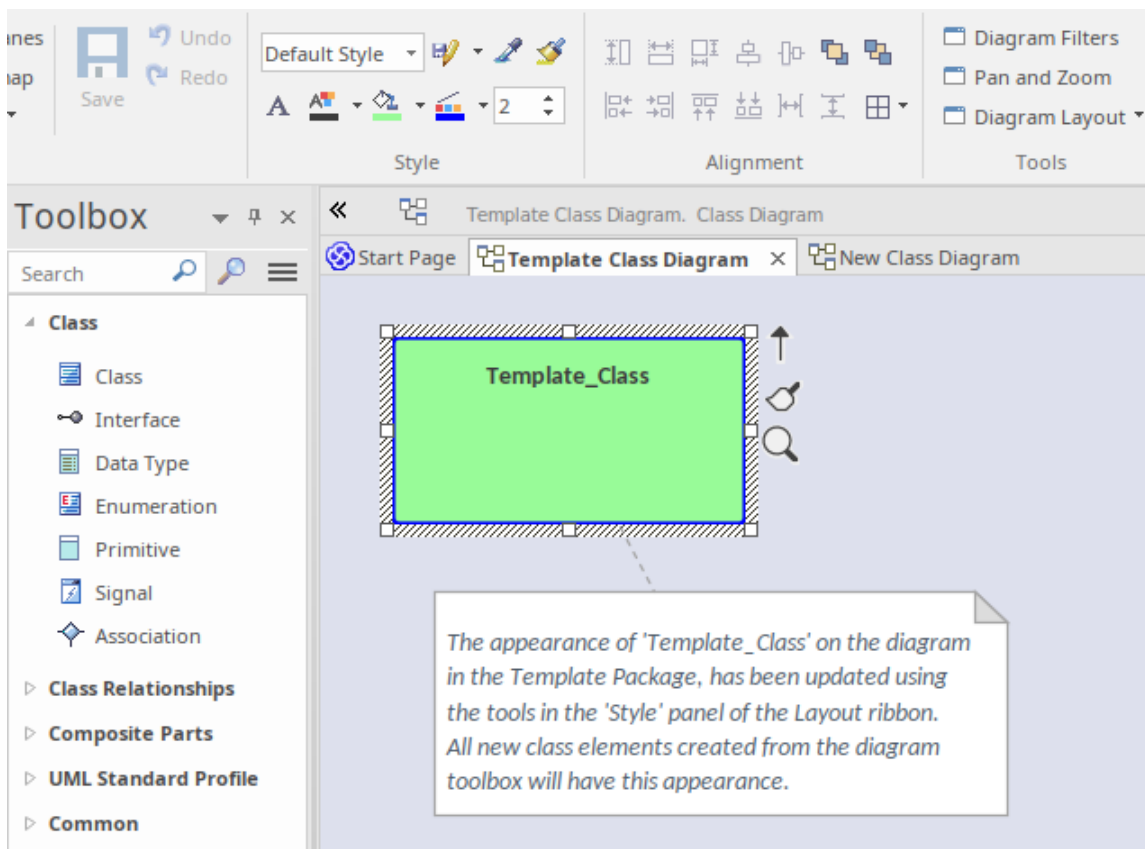

When a new 'Class' element is created from the toolbox, it is created with the same *default* appearance properties as the underlying template element, however its appearance on the diagram where it is created, replicates the appearance of the template element on the template diagram.

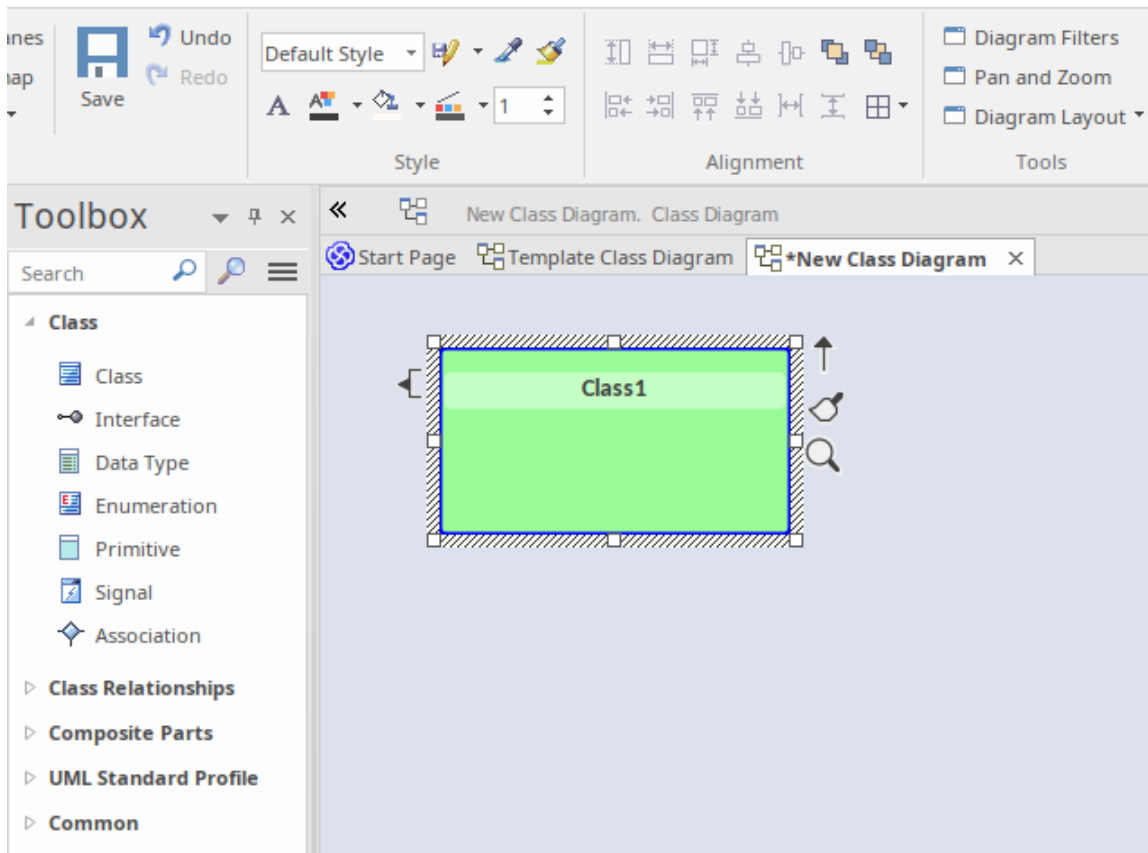

You can revert the element's appearance back to the default, by selecting the element and applying the 'Default Style' from the Layout ribbon, or by choosing the ribbon option 'Layout > Diagram > Appearance > Reset Local Element Appearance'.

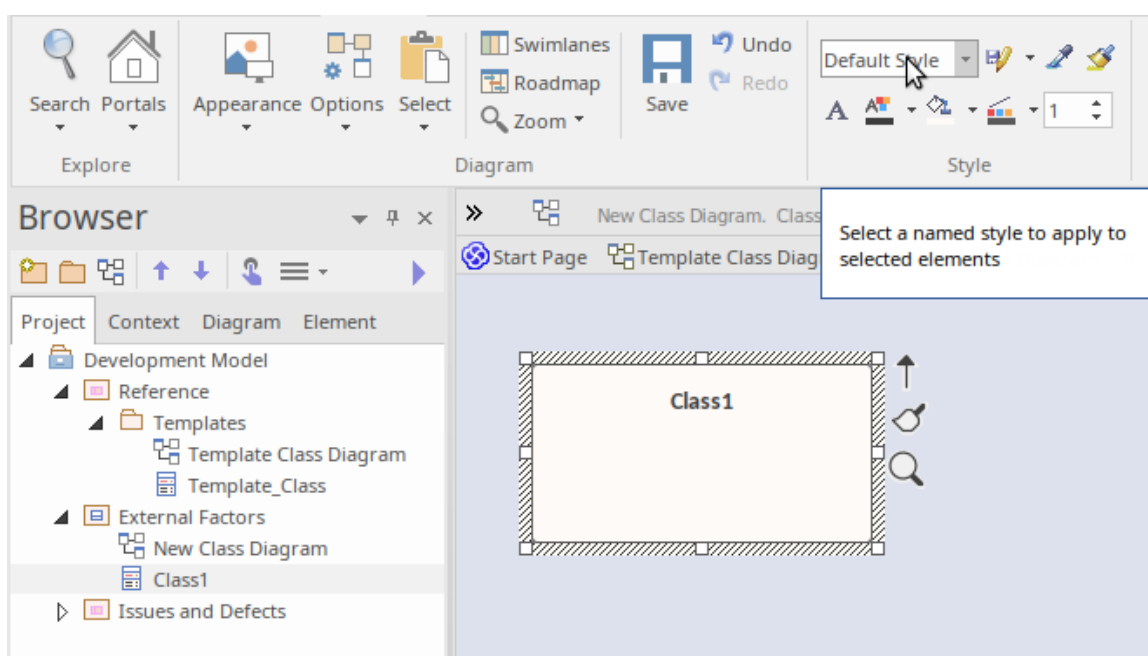

Similarly, if 'Class1' was deleted from 'New Class Diagram' (but not from the model) and then dropped back onto the diagram from the Browser window, it would be created using the *default* appearance copied from Template_Class, **not** the appearance displayed on the template diagram.

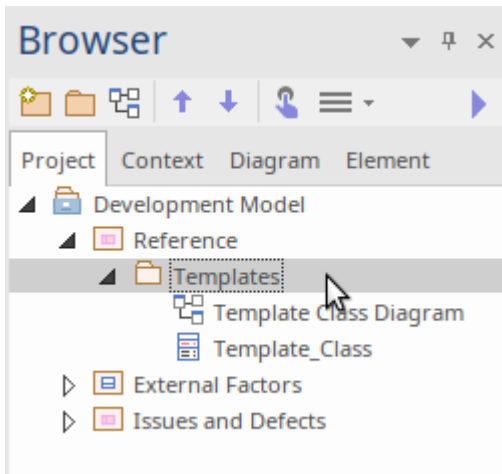

You can create the Templates Package anywhere in your model; however, it is better to create it in a location that is not likely to be accidentally changed or lost in any project development work.

Set up the Element Templates Package

Step	Action
1	Create a new Package. 'Templates' is used as the Package name in the illustration, but you can give the Package any name you prefer.
2	Within the template Package create new diagrams, one for each type of diagram to template.

	<p>Give the diagrams easily recognized names; for example Class Template for the template for Class diagrams.</p>
3	<p>Add elements to the template Package (each element must also appear on one, and only one, diagram), and configure the size, appearance, notes, version and other properties that you want new elements to have. You can use a standard UML element or a stereotyped element as the base for your template definition.</p>
4	<p>To specify the Package to use as the Templates Package, select the ribbon option 'Settings > Reference Data > Settings > Project Template Package'.</p> <p>The Find Package window displays.</p>
5	<p>Locate and click on the Package you wish to set as the Templates Package, then click on the OK button. (You can set only one Package at a time as the Templates Package.)</p> <p>Now each new element or diagram you add to your project is created with the settings from the appropriate template element or diagram.</p>

Notes





- In the Corporate, Unified and Ultimate Editions of Enterprise Architect, if security is enabled you must have 'Manage Reference Data - Update' permission to set up or access the Templates Package
- The fill color for an element derived from the template can be overridden by the element fill color defined by a Shape Script applied to the element via a stereotype, or you can switch to or change the default appearance in the 'Default Appearance' dialog
- If you decide not to use any templates, set the Templates Package to '<none>' in the Find Package window; the '<none>' Package is at the bottom of the hierarchy shown in the window
- An alternative way in which you can modify the immediate appearance of elements as you create them in diagrams is to redefine them, either under the same type name or as new element types, in a UML Profile

Set Element Font

When you display an element on a diagram, the text font defaults to a global setting defined from the 'Diagram Appearance' page of the 'Preferences' dialog. You can change this global default setting if you need to. On the diagram, however, you might want to change the font only on a specific element or group of elements, to distinguish them from other elements. You have several options for doing this.

Access

Select the element in a diagram, then use one of these options.

Ribbon	Layout > Style >  (Set Font)
Diagram	Click on an element  (Format Toolbar)  (Set Font) or Right-click an element click  (Set Font) in the toolbar above the context menu

Font Dialog Options

Option	Action
Font	<p>Scroll through the list of font types and click on the name of the appropriate font, which is then displayed in the field at the top of the list.</p> <p>This setting affects all text in the selected element except for the Note compartment text.</p>
Font Style	<p>In the list of font styles click on the name of the appropriate style, which is then displayed in the field at the top of the list.</p> <p>This setting affects all text in the selected element except for the Note compartment text.</p>
Size	<p>Scroll through the list of font sizes and click on the appropriate size, which is displayed in the field at the top of the list.</p> <p>Alternatively, type the font size directly into the field.</p> <p>This setting affects all text in the selected element.</p>
Strikeout	<p>(This checkbox is not currently available.) Select this checkbox to show the element text with a line through it.</p>

Underline	Select this checkbox to show the element text with an underline.
Color	<p>Simply click on the drop-down arrow and click on a color in the list.</p> <p>Notes:</p> <ul style="list-style-type: none"> • If you access the 'Font' dialog through the 'Font Style' field of the 'Default Appearance' dialog, the 'Color' field will be inactive • The color option at the top of the drop-down list is the 'Default' color set on the 'Preferences' dialog (or, if this has been overridden for this element, the color set in the 'Default Appearance' dialog) • If the current font color is a custom color applied through, for example, the Format Toolbar in the diagram, that color is second in the list, identified by the 'Custom' option
Script	If Western script is not appropriate for the element text, click on the drop down arrow and select a different script type.
Sample	Review the combined effects of the settings you have selected.

OK	Click on this button to save your changes.
Cancel	Click on this button to close the dialog without saving any changes.

Notes

- If you set the element font through the 'Default Appearance' dialog (F4) the changes can be overridden by any different values set through the other two access paths
- The 'Font' dialog overrides the 'Default Appearance' dialog for all selected elements when the font is applied.

Move Elements Between Packages

If an element or Package is not in the most appropriate part of the model structure, you can move it to a different location in the Browser window, either by:

- Dragging and dropping the element to a target destination, or
- Cutting and pasting the element or Package

If you move a Package, all the subordinate Packages and their contents are moved to the new location also.

Drag an element between Packages

Step	Action
1	Click on the element in the Browser window. See 'Customer' in the example diagram.
2	Drag the cursor so that it is over the target Package icon. The 'drop element' cursor is displayed while dragging.

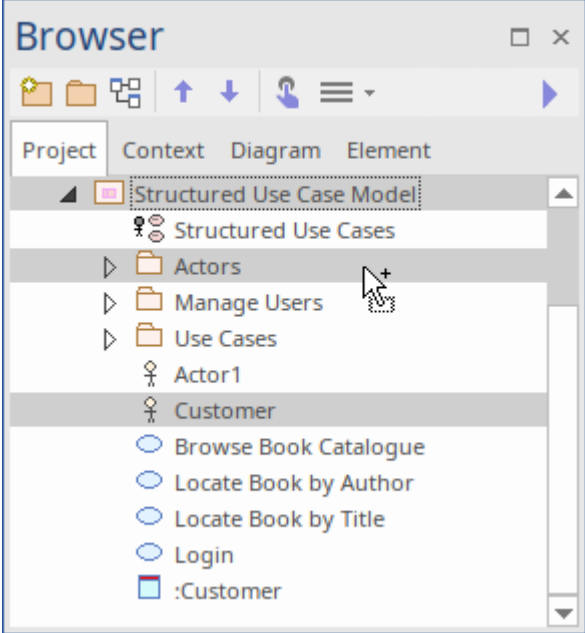
	
3	<p>Release the mouse button. The element is moved into the target Package.</p>

Cut and Paste the Element

Step	Action
1	<p>In the Browser window, right-click on the element to be moved and select the 'Copy / Paste Cut' option. The selected element is highlighted.</p>
2	<p>Right-click on the Package or element under which to move the cut element, and select the 'Copy / Paste Paste' option.</p>

The cut element is listed as a child of the selected element or Package, in the Browser window.

Notes

- You can also drag the element under a host element in the new Package; for example, drag an element under a Class
- Moving an element has no effect on any relationships that the element might have
- Moving an element in the Browser window has no effect on the use of that element in any diagram
- Moving a diagram generally does not affect the location of elements in Packages - if you move a diagram out of one Package into another, all the elements in the diagram remain in the original Package; however, certain elements (such as Decision, Initial and Final elements) are used only within one diagram, have no meaning outside that diagram, and are never re-used in any other diagram, therefore, if you move a diagram containing these elements they are moved to the new parent Package with the diagram
- In a multi-user environment, if one person moves or updates the Browser window structure, other users must reload their project to see the latest changes in the Browser window; although this is true of any addition or modification to the tree, it is most important when big changes are made, such as dragging a Package to a

different location

Copy Elements

You can quickly and easily duplicate one or more elements, with their child elements and diagrams, under other elements or Packages. You can insert a copy of an element under one or more other elements or Packages, in the same project file or any other project file.

It is not possible to duplicate an element on the *same* diagram, but you can generate representations of the element at the ends of connectors, called virtual connector ends. See the *Virtual Connector Ends - Represent One Element Several Times on a Diagram* Help topic.

Operations

Operation	Actions
Copy the Elements	<p>In the Browser window, select the elements to copy, right-click on one and select:</p> <p style="padding-left: 40px;">'Copy / Paste Copy to Clipboard Full Structure for Duplication'</p> <p>Alternatively, click on a selected element and press Ctrl+Shift+C.</p> <p>The 'Copying Selected Element(s) to Clipboard' dialog briefly displays while the copy operation completes.</p>

Paste the Elements

In the Browser window, right-click on the element or Package into which to paste the copied elements, and select the 'Copy / Paste | Paste Element(s) from Clipboard' option.

Alternatively, click on the Package and press Ctrl+V.

The 'Pasting Element(s) from Clipboard' dialog briefly displays while the paste operation completes.

The target element or Package is expanded and the pasted elements are exposed in the Browser window. If you are pasting the elements within the same model as the copied source, the source parent Package is also collapsed.

If the target element or Package already contains:

- An element of the same type with the same name as a pasted element, the pasted element name has the suffix - Copy
- An element with the same type and name as the pasted element including the - Copy suffix, the suffix becomes - Copy1 (or - Copy2, - Copy3 and so on, as copies of the element accumulate in the target element or Package)

You can keep the same element names as

	the source, or you can rename each element either by clicking twice on it and editing the name in the Browser window, or by double-clicking on it and editing the name in the 'Properties' dialog.
--	--

Notes

- If you want to copy any elements to paste under another element, the target element must be capable of receiving the child elements; for example, you cannot paste a Class element as a child of a Port
- A copy of an element does not have the external cross references of the source element; that is:
 - if one element is copied it has no connectors
 - if more than one element is copied, only the connectors between the copied elements are retained
 - however, if those elements come from a Sequence or Communication diagram and the diagram itself is not copied, the message connectors between the copied elements are not retained
- You cannot paste an element into an element or Package that is locked by another user or that is checked in; the 'Paste...' option is grayed out in the context menu

Copy Features Between Elements

As well as copying elements between Packages using a diagram, you can also copy features - attributes and/or operations - between elements in a similar way, dragging the features from an element in the 'Project' tab of the Browser window or 'Details' tab of the Inspector window and dropping them onto another element in a diagram.

Copy a single element feature

Open a diagram containing the target element. In the 'Project' tab of the Browser window or 'Details' tab of the Inspector window, click on the attribute or operation and drag it onto the element in the diagram.

In this example, the attribute `Account` is being dragged and copied from the `Customer` element on the 'Project' tab into the `AccountItem` element in a diagram. The process from the 'Details' tab is, visually, almost identical.

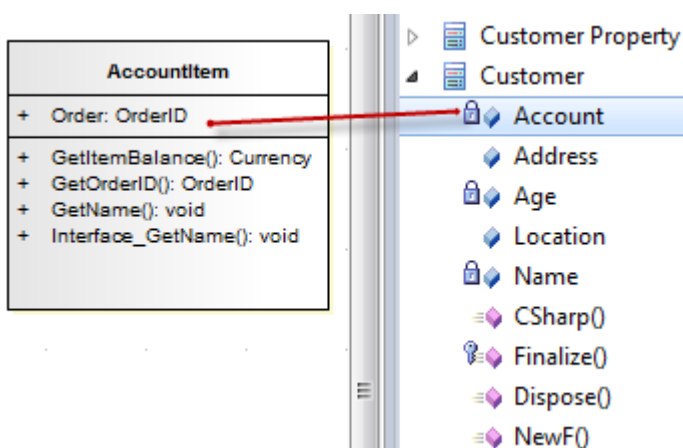

This image shows `AccountItem` after the attribute `Account` has been dropped on to it.

AccountItem
- Account: CustomerAccount
+ Order: OrderID
+ GetItemBalance(): Currency
+ GetOrderID(): OrderID
+ GetName(): void
+ Interface_GetName(): void

Notes

- You can also select and copy multiple features at the same time; you simply press Ctrl or Shift as you select the features in the element in the 'Project' tab of the Browser window, drag them onto the diagram and drop them into the target element (you cannot copy multiple features from the 'Details' tab of the Inspector window)

Highlight Context Element

When you click on an element on a diagram, it becomes the context element; that is, all actions take effect on that element. The context element has black rectangles on its border, firstly to indicate that the element is selected and secondly to act as 'handles' that you can click on and drag to enlarge or shrink the element.

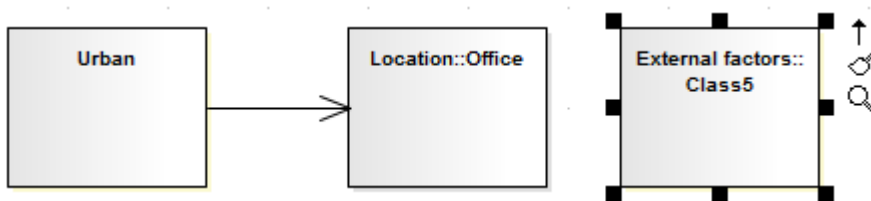

Many actions that you can take on an element involve selecting menu options or working on windows and dialogs that are separate from the element, and on a large or complex diagram you can lose track of the context element. To make every context element more visible, you can configure the system to add a hatched border to the element.

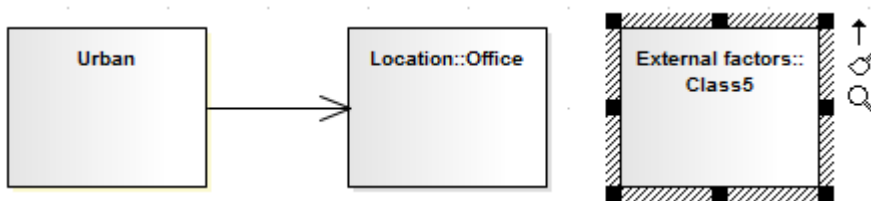

Access

To add a hatched border to the context element, open the 'Preferences' dialog using one of the methods outlined here, then select the 'Always Highlight Context Element' checkbox on the 'Diagram Behavior' page.

--	--

Ribbon	Start > Application > Preferences > Preferences > Diagram > Behavior: Always Highlight Context Element
--------	--

Multiple Selection

If you select multiple elements to work on at the same time, the context element has a hatched border by default, regardless of whether the 'Always Highlight Context Element' checkbox is selected or not. The context element here is the element against which other selected elements are aligned, or through which the changes to properties are made.



Notes

- If you have selected multiple elements and you want to change which element is in context, simply click once on the element that is to become the context element

Move Features Between Elements

As well as moving elements between Packages in the Browser window, you can also drag and drop features - attributes and operations - between elements to move them out of the source element and into the target element.

Move element features

Perform these actions in the order in which they are listed.

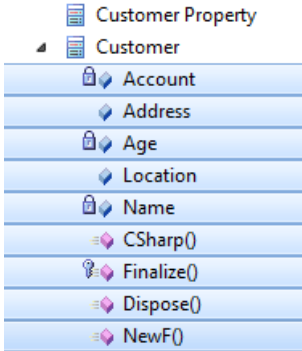
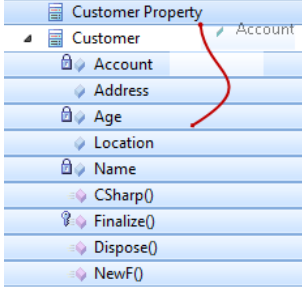
Images	Action
	<p>In the Browser window, click on the attribute or operation to move from the source element.</p> <p>If you are moving several features at once, while you click on the features hold down:</p> <ul style="list-style-type: none"> • Ctrl (several individual features) or • Shift (the first and last features in a range)
	<p>Holding down the mouse button, drag the attributes and/or operations to the target element.</p> <p>A single feature symbol (and, under some operating systems, the first feature name) displays under the cursor during the</p>

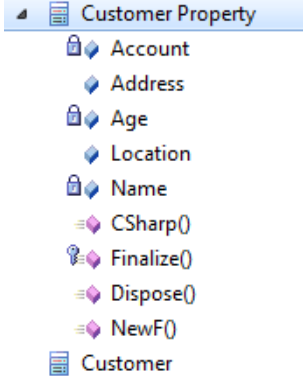
	<p>move; however all of the selected features are moved.</p>
	<p>Release the mouse button. The features that you selected and drag/dropped are now features of the target element, as seen in the Browser window.</p>

Insert Related Elements

Elements can be used more than once in a model, either individually or as a group. If you want to reproduce an existing set of elements that have one element as the focus, without copying and linking the elements individually in the new diagram, you can use the Insert Related Elements facility. With this facility, you drag the context element from the Browser window onto your diagram, right-click on it and select to add related elements. The 'Insert Related Elements' dialog displays, on which you can specify:

- Which types of relationship to filter on, and what direction these relationships have
- Which types of element to filter on
- Which Package the related elements exist in
- How many levels of relationship to bring in; that is, just the elements immediately related to the focus element, or also elements related through those elements
- Whether to add all elements that satisfy the criteria you have specified, or just those you select
- Whether or not to automatically re-organize the diagram when the related elements have been added

Access

First, select an element on the diagram, then:

Ribbon	Design > Element > Add Element >
--------	----------------------------------

	Related Element
Context Menu	Right-click on element Insert Related Elements

Define selection criteria to insert related elements

Field/Button	Action
Connector types	<p>Displays the types of relationship in which the selected element and, if more than one level of relationship is selected, its related elements are currently involved.</p> <p>To limit the inserted elements to those connected by specific relationship types, select the checkbox against each of those types of connector.</p> <p>To deselect a selected checkbox, click on it again.</p>
Element types	<p>Display the types of element to which the selected element and, if more than one level of relationship is selected, its related elements are connected.</p>

	<p>To limit the inserted elements to those of specific types, select the checkbox against each of those types.</p> <p>To deselect a selected checkbox, click on it again.</p>
Link Direction	<p>Limit the inserted elements to those in incoming or outgoing relationships with the selected element; click on the drop-down arrow and select the appropriate direction, or <All> for either direction.</p>
Limit to Namespace	<p>Restrict the inserted elements to those from a specific Package; select the namespace from which the elements are to come. Select <None> for elements in any namespace.</p>
Find relationships to: levels	<p>Click on the drop-down arrow and select the level down to which to insert connected elements, between levels 1 (immediately related elements) and 5 (elements 5th in a chain from the focus element).</p> <p>You can select levels 4 or 5 to see how far the element/relationship hierarchy extends, but as this can produce a complicated and tangled diagram, it is</p>

	<p>better to use level 1 or 2 on selected elements in turn.</p>
<p>Refresh</p>	<p>Click on this button to locate and list all elements that satisfy the criteria you have specified.</p> <p>Each list item shows the depth at which the related element exists in relation to the focus element, the name of the element, its parent Package, and whether it is currently in the diagram.</p> <p>If there are many entries, you can re-organize them for clarity using the 'Drag a column header...' panel.</p> <p>If you want to add an element to your diagram, select the checkbox against that element. Alternatively, to select all elements, click on the All button.</p> <p>To deselect all selected checkboxes, click on the small Clear button.</p> <p>To empty the list panel altogether, click on the large Clear button.</p>
<p>Layout Diagram when complete</p>	<p>Select the checkbox if you want the system to layout the diagram after the elements have been inserted; the layout applied is the Digraph layout.</p> <p>If no elements have been added, this option has no effect; elements have to be</p>

	added for the system to adjust the layout.
OK	Click on this button to add the selected elements to the diagram and close the dialog.



Notes

- If the selected element has a relationship to an edge-mounted structural element such as a Port or Exposed Interface, adding the Port or Interface to the diagram using the 'Insert Related Elements' dialog will also add the associated parent elements onto the diagram, if they are not already shown

Change Element Type

You might find that an object that you have represented as one type of element would be better represented as another type. The 'Select Element Type' dialog allows you to change the type very quickly and simply.

Access

Ribbon	<p>Design > Element > Manage > Change Type</p> <p>Explore > Portals > Windows > Properties > Properties : In the Type field of the Properties window, click on the  button</p> <p>Start > Application > Design > Properties : In the Type field of the Properties window, click on the  button</p>
--------	---

Change Type

On the 'Select Element Type' dialog, click on the 'Element Type' drop-down arrow and select the new element type from the list.

Click on the OK button.

The target element is transformed into the required type.

Notes

- This operation is effective on basic UML elements, but has limited use for profile-stereotyped elements such as those used in BPMN or ArchiMate modeling

Make Linked Element a Local Copy

When you use an element on more than one diagram, you drag the element from the Browser window and drop it onto the diagram either as a link to the original element or as a separate instance or copy of the original element.

Subsequently, you might decide to change a link to the element into a new object, as a local copy of the element in the same Package as the diagram. You can do this very quickly and simply by selecting a menu option.

Access

Context Menu	On diagram, right-click element Advanced Convert Linked Element to Local Copy
--------------	---

Notes

- 'Convert Linked Element to Local Copy' will only be available if the element being converted and the diagram it is on are in different Packages.

Set an Element's Default Appearance

All elements that you use have global default appearance settings for:

- The fill, border and font colors
- Font styles, including font face and size
- The border thickness

You define these settings on the 'Preferences' dialog.

However, you can change the default appearance for a specific element on all diagrams on which it is found, using the 'Default Appearance' dialog.

Access

Context Menu	Right-click on element Appearance Default Appearance
Keyboard Shortcuts	F4 or Ctrl+Shift+E

Options

Option	Action

<p>Background Color</p>	<p>Click on the drop-down arrow and select the fill - or background - color of the element.</p> <p>If you want to use a color that is not available, click on the More Colors button and define the required color.</p>
<p>Border Color</p>	<p>Click on the drop-down arrow and select the border color for the element.</p> <p>If you want to use a color that is not available, click on the More Colors button and define the required color.</p>
<p>Border Width</p>	<p>Type in the width of the border surrounding the element, or use the increment/decrement arrows to the right of the field.</p> <p>The minimum width setting is 1, the maximum is 5.</p> <p>If you set this value to the current model default value, any updates to the default value are immediately applied to this local 'Border Width' field, until you specifically reset the local field to a non-default value. (The current model default border width is set in the 'Default Element Border Width' field; select the 'Start> Appearance > Preferences > Preferences' ribbon option and the</p>

	'Diagram > Appearance' page.)
Font Style	<p>Displays the current font typeface for the element text. To change this, click on the  button.</p> <p>The 'Font' dialog displays, on which you can select a different typeface, style (such as bold/italic) and font size.</p> <p>You can also select to use or cancel underlines, and (if necessary) select a different script classification.</p>
Font Color	<p>Click on the drop-down arrow and select the font color to apply to the text of the element.</p> <p>If you want to use a color that is not available, click on the More Colors button and define the required color.</p>
Reset to defaults	(Optional) Click on this button to reset all appearance settings to the system default values.
Preview	Displays a representation of the colors, border width and font styles, which updates as you choose the new settings.
OK	Click on this button to close the dialog and apply the appearance settings you

	have defined.
Cancel	Click on this button to close the dialog and abort all the changes you have made within the dialog.

Notes

- You can adjust several elements at the same time; select all of the required elements, right-click on one of them and select the 'Appearance | Default Appearance' option
- You can also define for the element a default image that displays for all instances of the element in diagrams across the model
- If the 'Show Project Custom Colors in Color Combo Boxes' checkbox is selected on the 'Standard Colors' page of the 'Preferences' dialog, the last 16 color squares in the color selection palettes contain the project colors set on that page
- The 'Font Color' field affects only the element name text; it does not override the feature text colors as defined on the 'Standard Colors' page of the 'Preferences' dialog
- When called from the 'Default Appearance' dialog, the 'Color' field on the 'Font' dialog is not available; font color is set in the 'Font Color' field on the 'Default Appearance' dialog
- The 'Font' and 'Font Style' fields on the 'Font' dialog affect

all text except for the Note compartment text

- The 'Size' field on the 'Font' dialog affects all text
- An alternative option for changing an element's appearance is to define a stereotype that has different fill, border and font settings, or that has either a Shape Script or an image file associated with it; you can then assign the stereotype to the element to change the element's appearance to that defined by the stereotype
- The 'Default Appearance' options override all other styles except those set via a Shape Script (such as fill color and line width) or those applied locally on a diagram (using options in the Layout | Style panel of the ribbon, for example)

Feature Visibility

When you set up the characteristics and features of an element, you can set a collection of options to display or hide the features of that element on a specific diagram. You can also filter the attributes and operations that are shown by scope - such as hiding all protected attributes - or select to hide or show specific attributes and operations. The visibility you set applies only to the current diagram, so a Class can appear in one diagram with all features displayed, and in another with features hidden.

It is possible to hide or show inherited attributes, operations, responsibilities, constraints and Tagged Values for elements that support those features. When the system displays inherited features, it creates a merged list from all generalized parents and from all realized interfaces. If a child Class redefines something found in a parent, the parent feature is omitted from the list.

Access

Context Menu	Right-click element on diagram Compartment Visibility
Keyboard Shortcuts	Ctrl+Shift+Y

Customize Feature Visibility

Field/Button	Action
Attribute Visibility	Select the checkbox against each scope that should be visible, and clear the checkbox against each scope that should not be visible.
Operation Visibility	Select the checkbox against each scope that should be visible, and clear the checkbox against each scope that should not be visible.
Custom	<p>Click on this button to show or hide specific operations or attributes. The 'Show Features in Diagram' dialog displays, on which you select the features to show.</p> <p>On the right of the dialog is a 'Show' field with a drop-down arrow; if you click on this and select the 'Hide' option, the dialog alters slightly to become the 'Suppress Features in Diagram' dialog, on which you select the features to hide.</p> <p>The two dialogs are identical. Select the checkboxes of specific features to show or hide on the element in the diagram.</p>

	<p>You can specify both attributes and operations on the same dialog, by selecting the appropriate radio button for the type of feature to work on.</p> <p>You can also use the:</p> <ul style="list-style-type: none">• 'Filter by' drop-down arrow to filter the list to show only features that have a specific scope• All button to select all operations or attributes in the list• None button to clear the checkboxes against all selected operations or attributes in the list
<p>When Resizing Elements</p>	<p>Select the appropriate option for resizing the Class, Object or Table to manage very wide diagram objects. Select the:</p> <ul style="list-style-type: none">• 'Resize to longest Feature' radio button, so that the minimum width for a diagram object is determined by its longest displayed attribute, operation or other compartment value• 'Wrap Features' radio button (so that any long features are wrapped onto multiple lines) or• 'Truncate Features' radio button (the default - long features are not displayed in full)

Runstate	Select the checkbox if you want to hide the object runstate of the element on the diagram.
Hide Stereotyped Features	<p>If you do not want to show attributes or operations that have a particular stereotype, type that stereotype name - exactly as defined - in this field; the field is case-sensitive.</p> <p>If you want to specify more than one stereotype, separate the stereotype names with a comma.</p>
Show Element Compartments	<p>Select the checkbox against each compartment to display in the element on the diagram. If you want to display inherited attributes, operations, tags, requirements and/or constraints as well as directly owned ones, select the checkbox against each inherited feature as well as against the general feature.</p> <p>See also the <i>Notes</i> section later in this topic.</p>
Element Notes	Select the 'Notes' checkbox in the 'Show Element Compartments' list to display, in a compartment on the element in the diagram, the text that has been typed into

	<p>the 'Notes' field of the element 'Properties' dialog. This compartment does not have a 'Notes' heading.</p> <p>You can display full notes for the selected element whilst the other elements on the diagram have no notes text.</p> <p>This checkbox also enables the 'Maximum' field, which defaults to 1000 as the number of characters of Notes text that can be displayed. Overtyping this value to display less text or more text, as you need.</p>
OK	<p>Click on this button to save your settings. The diagram redisplayed with the appropriate level of feature visibility.</p>

Notes

- To show features for element types that - by default - do not have visible compartments, such as Use Cases and Actors, right-click on the diagram object to display the context menu and select the 'Appearance | Use Rectangle Notation' option
- You can configure Enterprise Architect to display the text in all Notes compartments in italics - select the 'Start >

Appearance > Preferences > Preferences' ribbon option and on the 'Diagram > Appearance' page select the 'Italic Note Element text' checkbox; this has an immediate effect, as does clearing the checkbox to show the text in normal font

- If you select to display the Resources compartment, note that this shows both currently-active and complete resource allocations
- The Discussions and Reviews compartments display the first two lines of each open topic on the element; they do not include closed discussions or reviews
- Some technologies such as SysML define additional compartments in the element, such as for Ports, Parts and Flow Ports; visibility of these compartments will also be controlled by a checkbox matching the name of the compartment
- The Tags compartment lists all Tagged Values for an element as entered in the 'Tags' tab of the element Properties window that do not have an empty value
- If you select the 'Fully Qualified Tags' checkbox, the Tags compartment will contain the full provenance of each Tagged Value (if created in Enterprise Architect release 7.1 or later) where the same Tagged Value is used several times in different contexts with different values; the description in the Tags compartment reads:

`<Profile>::<Stereotype>::<Tagged Value name>=<Value>`

For example:

`BPMN::Activity::Activity Type = Task`

- A Structure Compartment displays on the element by default when you add child elements such as Parts and Classes; the Structure Compartment acts as a container for the child elements, which are normally fixed within the compartment
To move child elements out of the compartment, press the Ctrl or Shift key while dragging the child element;
Parts/Properties cannot be dragged out of the parent element
Any element that supports Rectangular Notation can support a Structure Compartment
An option on the 'Manage Model Options' dialog enables and disables Structure Compartments for the whole model
- Ports and other edge-mounted elements normally bind to any part of the parent element border, but can be confined to the borders of the Structure Compartment by right-clicking on the parent element and selecting the 'Behavior > Bind Port to Compartment' option
- If you want to apply a structure and formal relationships to the child elements, create a proper Composite Structure diagram containing the elements and select the 'Show Composite Diagram in Compartment' context menu option

Align Elements

When you have created a number of elements on a diagram, you might want to organize them in groups so that they form a column or row with a uniform edge. You can do this quickly and easily by selecting the group of elements and aligning them all against the left, right, top or bottom edge or center of one element in the group. You can also space three or more elements evenly in a row or column, at an average of their previous separations.

The selected elements are aligned with respect to the 'context' element, which is the element that has a hatched border drawn around it. You can set a given element as the 'context' element by clicking on it or when you add it to the current selection group using 'Ctrl+Click'.

Access

Ribbon	Select a set of elements, then <ul style="list-style-type: none">Layout > Alignment > <alignment button>
Context Menu	Select a set of elements, then right-click on a selected element and choose: <ul style="list-style-type: none">Align LeftAlign RightAlign Top

	<ul style="list-style-type: none"> • Align Bottom • Align Centers Vertically • Align Centers Horizontally • Align Centers Left to Center (left edge of elements align with center of last-selected element) • Align Centers Right to Center (right edge of elements align with center of last-selected element) • Align Centers Top to Center (top edge of elements align with center of last-selected element) • Align Centers Bottom to Center (bottom edge of elements align with center of last-selected element) • Space Evenly Across • Space Evenly Down
<p>Keyboard Shortcuts</p>	<p>Select a set of elements (ensuring that the 'context' element is correctly set), then</p> <ul style="list-style-type: none"> • Ctrl+Alt+Left Arrow (align left) • Ctrl+Alt+Right Arrow (align right) • Ctrl+Alt+Up Arrow (align top) • Ctrl+Alt+Down Arrow (align bottom) • Alt+'-' (space evenly across) • Alt+'=' (space evenly down)

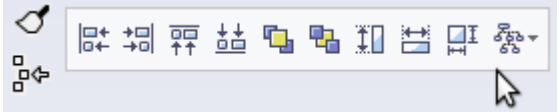
<p>Other</p>	<p>Click on the context element in the selection and on the  icon, then select the appropriate alignment icon from the toolbar.</p> 
--------------	---

Align multiple elements

Step	Action
1	Select a group of elements.
2	<p>Right-click on the element in the group to align others to.</p> <p>The context menu displays.</p>
3	<p>Select the alignment function you require.</p> <p>All selected elements are aligned with the one beneath the cursor.</p>

Notes

- You can also use the first four buttons of the Diagram

toolbar to align elements; these are made available when more than one element is selected in a diagram

- If you have a single element that you want to move into alignment with another, an alternative method is to use the 'smart placement guides' which indicate where the navigation points (edges and center points of edges) on the element are in relation to the adjacent element

Resize Elements

You can change the size of an element, or of several elements in a group, using the cursor or various menu options.

Resize using handles

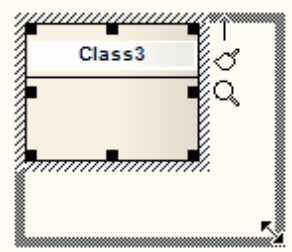
Image	Detail
	<p>Select an element or group of elements in the diagram, then:</p> <ul style="list-style-type: none">• (Single element) With the mouse, drag the resize handles that appear at each corner and side, to resize the element (the cursor switches to the double-ended arrow as shown in the image) <p>If you have enabled the 'Layout > Alignment > <grid options> Smart Placement' and 'Show smart placement guides' options, as you move the resize handles the guide lines display to show where the resizing top, bottom, sides or edge center points are in relation to an adjacent element, but note that the objects must be contemporary - not at different hierarchical levels or in</p>

	<p>different partitions of the diagram</p> <ul style="list-style-type: none"> • Press and hold Ctrl and use the Arrow keys to resize elements by increments; to make elements: <ul style="list-style-type: none"> - Wider - press Ctrl+Right Arrow - Narrower - press Ctrl+Left Arrow - Taller - press Ctrl+Down Arrow - Shorter - press Ctrl+Up Arrow • Autosize selected element(s) to their default size using 'Layout > Diagram > Select > Autosize Selected Elements', or by pressing Alt+Z <p>If you select multiple elements, 'Autosize' is also available in the right-click context menu for the elements.</p>
--	---

Resize a Set of Objects to a Specific Size

Image	Detail
	<p>If you right-click a selected set of objects, you can resize them to the same dimensions (height, width or both) using context menu options.</p> <p>When you select multiple elements using Ctrl+click, you can right-click and select options that use the dimensions of the</p>

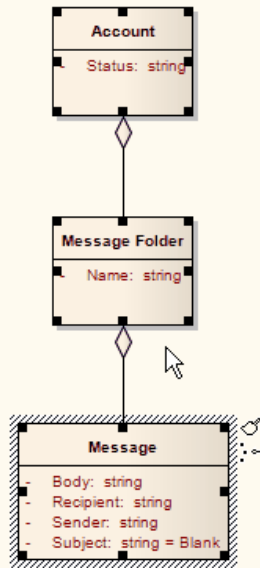

last-selected (hatched) object to set the dimensions of the other selected objects.

For example, in this diagram, the Message Class height and width are used to set the height and width of the Account and Message Folder Classes.

The steps are:

1. Set one element to the required size (for example, Message).
2. Select that element and the elements to resize (for example, Account and Message Folder).
3. Right-click on the pre-sized element (Message).
4. Select the appropriate resizing option ('Same Height', 'Same Width', or 'Same Height and Width').

Element Grouping

There are several situations in which you might want to operate on a number of elements at the same time, such as to align them in a certain orientation or to move them whilst maintaining that orientation, or to reformat the elements with the same characteristics. To group the elements you can:

- Click on specific elements while pressing the Ctrl key or Shift key, or
- Click on a point on the diagram and drag diagonally across a number of adjacent elements to select all elements within the dragged boundary

These two methods set a temporary grouping. You can also fix the selection to group the elements permanently during a sequence of work sessions, until such time as you specifically ungroup them again.

Grouping Elements

With multiple elements selected on a diagram, right-click on any of the elements and select the 'Group Elements' option. Whenever you click on one of the grouped elements, the others in the group are selected as well.

Ungrouping Elements

Right-click on any of the grouped elements and select

'Ungroup Elements' to make all the elements in that group individually selectable again

Notes

In a permanent grouping:

- Right-click on an unselected group element to display context menu options for working on that element alone; select the element and then right-click to display the context menu for working on multiple elements
- You can select another element either within the group or outside it using the keyboard arrow keys
- You can temporarily remove an element from the group for an operation, by pressing the Ctrl key as you click on it; when you click on the diagram background and back on the group, the excluded element is again part of the group
- You can update the appropriate windows with the properties and features of different elements in the group by double-clicking on the next element to investigate
- The feature complements the facility for setting bookmark values, either to add bookmarks to every element at once, or to set the same value to the bookmarks on the elements

Create Notes and Text

One aspect of modeling is to describe and document the purpose and use of an element in the context of a particular diagram. You can provide such documentation in the form of Note or Text elements displayed with and connected to the elements they describe.

Both Note and Text elements display text on the diagram; a Note element contains the text within a border with a background color and a turned-down corner image, whilst a Text element has no border or background color. Otherwise they behave in the same way.

Access

Context Menu	Right-click on element New Child Element Attach Note
Other	<ul style="list-style-type: none">• Diagram Toolbox : from the 'Common' page, drag the Note or Text icon onto diagram - drag the Quick Linker arrow from the Note element to connect to the element being annotated• Drag the Quick Linker arrow from an element into an empty space on the diagram > Common > Note

Complete a Note or Text element

The element displays on the diagram.

If, on the 'Objects' page of the 'Preferences' dialog, the 'Edit Object On New' checkbox is deselected, the Notes window displays, and you can type the element text within it. To display the text in the element, click on the element.

If the checkbox is selected, the 'Notes Properties' dialog immediately displays; type your text in the dialog, and click on the OK button to display the text in the element.

In either case, if you want to display the text in a more readable layout, you can resize the Notes window or dialog, and you can also format the text using the Notes toolbar.

Note element appearance

It is possible to change the appearance of a Note element, by right-clicking on the element and selecting one of the 'Appearance' menu sub-options. The available images are:

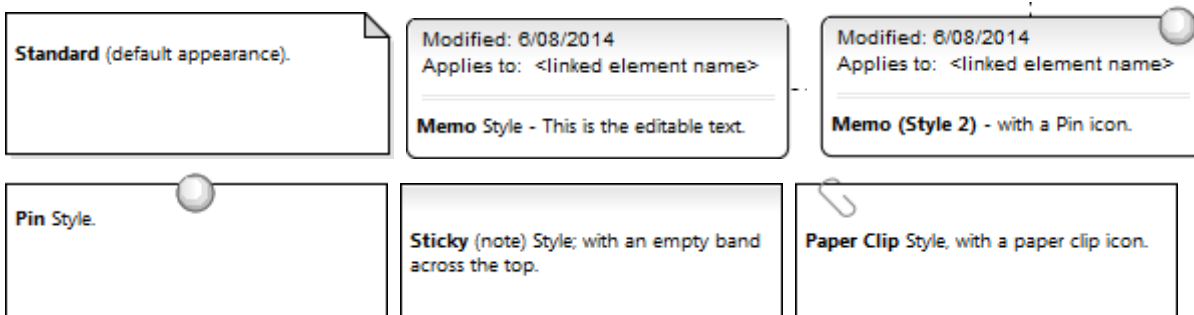

The two Memo-style images list all the elements that the Note is linked to, in the 'Applies to:' field. You can hide the actual Notelink connectors, so that the Note identifies the

elements it refers to without complicating the diagram appearance by having the connectors visible. To hide (and reveal) the connectors, click on the element and select the 'Advanced | Hide (Show) attached links' option.

You can also configure Enterprise Architect to display the text in all Notes and Text elements in italics. Select the 'Start > Appearance > Preferences > Preferences' ribbon option and on the 'Diagram > Appearance' page select the 'Italic Note Element text' checkbox. This has an immediate effect, as does clearing the checkbox to show the text in normal font.

Notes

- You can also create a Note or Text element by clicking on the New Note or New Text Element icon on the UML Elements toolbar and clicking on the diagram
- When you have created your Note or Text element, you can leave it free-standing to display information on the diagram, or you can connect it to the specific modeling element or elements it describes using a Notelink connector, which you also drag from the Common toolbox
- Instead of typing in text for the element, you can reflect an element's internal documentation, such as the value of a constraint or feature

Link Note to Internal Documentation

Whilst a Note often contains information in addition to that contained within other elements, you can also expose the internal description of a feature or property of an element. In this way you can externalize model documentation at the diagram level, and as the system keeps the Note and the internal text in synch, you do not have to update the Note; in fact, you are blocked from editing the Note text, because it is maintained automatically.

Similarly, it is also possible to expose the Notes text of the diagram properties in a Note element.

In this example, two Notes are connected to an element's internal structures. One Note is connected to an attribute and displays the attribute name and notes. The other is connected to a constraint, showing the constraint name and documentation.

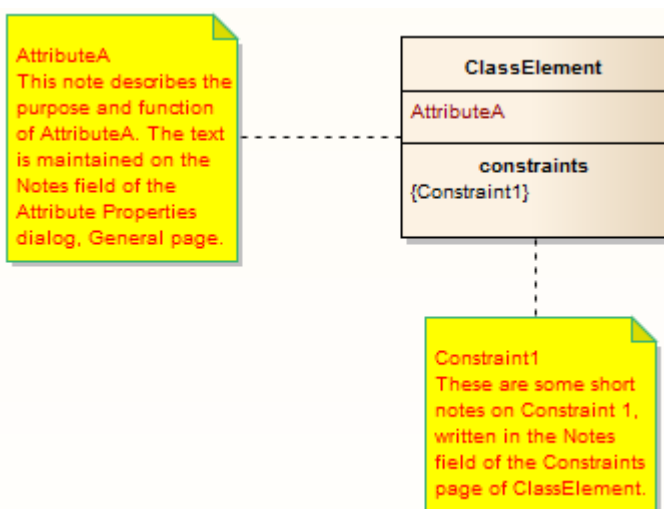

Connect a Note element to another element's feature

Step	Action
1	Click on the target element and then click on the feature itself, so that it is highlighted for inline editing.
2	Right-click on the feature and select the menu option 'Create Linked Note'. This creates a Note element linked to the selected feature, reflecting the content of that feature.

Alternatively

Step	Action
1	Insert or identify the target element in a diagram.
2	Drag the 'Note' icon from the 'Common' page of the Diagram Toolbox onto the diagram, next to the target element. The 'Notes' dialog displays. Do not type any text, simply click on the OK button.

3	Click on the 'Note Link' icon from the 'Common' page of the Toolbox, and drag the cursor from the Note to the target element to create the connector.
4	Right-click on the Note Link to display the context menu, and select 'Link this Note to an Element Feature'. The 'Link note to element feature' dialog displays.
5	In the 'Feature Type' field, click on the drop-down arrow and select the type of feature to link to. The 'Feature' list now shows the features of the selected type in the element.
6	In the Feature list, click on the specific feature to link to, and click on the OK button. The Note now automatically shows the contents of the feature's Notes or Description field, and is automatically updated with any changes to this field.

Connect a Note element to the diagram

Notes text

Step	Action

1	Open the diagram and right-click on the background.
2	Select the 'Properties' menu option, type an appropriate description in the 'Notes' field, then click on the OK button.
3	Drag the 'Note' icon onto the diagram, from the 'Common' page of the Toolbox. The 'Notes' dialog displays. Simply click on the OK button.
4	Right-click on the Note element and select 'Advanced Link to Diagram Note'. The Note now automatically shows the contents of the diagram's 'Notes' field, and is automatically updated with any changes to this field.

Notes

- You can unlink a Note linked to an element feature, leaving the Note text, which can be edited manually and directly as normal; to unlink the Note from an element feature, either:
 - Right-click on the Note and select the 'Advanced | Unlink from Element Feature' option, or
 - Right-click on the Notelink connector, select the 'Link this Note to an Element Feature' option and,

on the 'Link note to element feature' dialog, set the 'Feature Type' field to 'None'

Delete Elements from Diagram and Model

An element might become inappropriate in a certain context, so you would want to remove it from the diagram in which that context is represented. It is also possible that the element becomes unnecessary in the model as a whole, so you would want to delete it altogether. You therefore have a number of situations under which you would 'delete' an element:

- Just from a particular diagram
- As a member of a group of elements to be removed from a diagram
- From a diagram and from the model at the same time
- Directly from the model, through the Browser window

Delete an element just from a diagram

Step	Action
1	In the diagram, click on the element to delete.
2	Either: <ul style="list-style-type: none">• Press the Delete key or Ctrl+D, or• Right-click and select 'Delete <element name>'

	The element is immediately deleted from the diagram, but not from the model. There is no prompt to confirm the deletion.
--	--

Delete a group of elements from a diagram

Step	Action
1	In the diagram, press Ctrl while you click on each element to delete.
2	<p>Either:</p> <ul style="list-style-type: none"> • Press the Delete key or Ctrl+D, or • Right-click and select 'Delete selected elements' <p>The elements are immediately deleted from the diagram, but not from the model. There is no prompt to confirm the deletion.</p>

Delete an element from the model

Step	Action

1	<p>Either:</p> <ul style="list-style-type: none"> • In the Browser window, right-click on the element to delete and select 'Delete <element name>', or • In the diagram or Browser window, click on the element to delete and press Ctrl+Delete <p>A confirmation prompt displays, also offering an option to show the Traceability window so that you can check the impact of deleting the element.</p>
2	<p>Click on the Yes button.</p> <p>The element is completely removed from all diagrams in which it has been used, and from the model. If you delete an element in this way, you delete all its properties, child objects and connectors as well.</p>

Delete multiple elements from the model

Step	Action
1	<p>On the diagram or in the Browser window, press Ctrl as you click on the elements to remove from the model, to select them.</p>
2	<p>Press Ctrl+Delete to completely remove the elements</p>

	<p>from the model.</p> <p>Alternatively, in the Browser window, right-click on one of the selected items and select the 'Delete selected item(s)' option.</p> <p>In either case, a confirmation prompt displays.</p>
3	<p>In the diagram, the prompt is to confirm deletion of all elements from the model and all diagrams, at once. Click on the Yes button.</p> <p>In the Browser window, the prompt offers options to confirm and delete:</p> <ul style="list-style-type: none">• Each element individually (click on the Yes button), or• All the elements together (click on the Yes to all button) <p>The elements are completely removed from all diagrams in which they have been used, and from the model. If you delete elements in this way, you delete all their properties, child objects and connectors as well.</p>

Customize Visibility of Elements

Some modeling objects are, by default, not listed in Packages shown on diagrams, or in report documents. These include Events, Decisions, Sequence elements, Activity Endpoints and Association Classes. For example, in this Event Test Package, the Events and Decisions contained in the Package are not shown on the Package diagram.

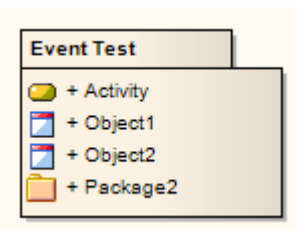

You have the option of turning on display of the hidden elements.

Access

Ribbon	Start > Appearance > Preferences > Preferences > Objects: Advanced
--------	--

Display Hidden Elements

Step	Action

1	On the 'Advanced Settings' dialog, select the checkbox against each type of element to show in Package diagrams and in report documents.
2	Click on the Close button on each dialog in turn.
3	<p>Reload the current diagram if required.</p> <p>The Package from the earlier example now shows the Event and Decision elements it contains.</p>  <p>The screenshot shows a package diagram titled 'Event Test'. It contains a list of elements with their respective icons and names: a yellow circle for '+ Activity', a blue arrow for '+ Event', a blue diamond for '+ Decision', a blue square for '+ Object1', another blue square for '+ Object2', and an orange folder icon for '+ Package2'.</p>

Set Up Cross References

It is possible to set up a cross reference (or Custom Reference) from one or more elements in a diagram to another element selected in the Browser window. You can also review the existing cross references on an element, using the 'Context References' dialog or the Traceability window.

Set up a cross reference

Step	Action
1	Open the diagram that contains the elements that will reference the target element.
2	In the Browser window, right-click on the target element (the object of the cross reference) and select: <ul style="list-style-type: none">'Add Add Custom Reference' (for a target element) The 'Set up references' dialog displays.
3	Click on the checkbox against each element that is to refer to the target element.
4	Optionally, in the 'Comment' field, type the purpose of the references.

5	Click on the OK button to set the references and close the dialog.
---	--

Use the cross reference

Step	Action
1	Click on the required element in the opened diagram.
2	<p>Either:</p> <ul style="list-style-type: none">• Right-click on the element and select 'Find Custom References' or• Press Ctrl+J <p>The 'Custom References' dialog displays, showing a list of elements that have been set as cross references for the selected element.</p>
3	<p>Optionally, open the 'Properties' dialog for a referenced element by clicking on it and clicking on the Open button.</p> <p>Similarly, open a referenced diagram by clicking on it and clicking on the Open button.</p>

- | | |
|---|---|
| 4 | If you have opened a string of diagram links, click on the Home button to return to the original diagram. |
|---|---|

Notes

- You can create cross references from an element on the diagram to a number of elements in the Browser window, and from another element on the diagram to different elements in the Browser window
- You cannot create a commented cross reference from one element on the diagram to an element in the Browser window, and a separate commented cross reference from a different element on the diagram to the same element in the Browser window
- You can delete a cross reference by selecting it on the 'Custom References' dialog and clicking on the Delete button; cross references are also automatically deleted if the source or target element in the reference is deleted
- You can also add, review and delete cross references on the 'Cross References' tab of the 'Scenarios' page in an element's 'Properties' dialog

Show Element Use

An object can be used several times in a model; for example, an image might be used for different elements on different diagrams, or an element might be represented on several diagrams depicting different concepts. You can quickly locate where the object is used in the model, by selecting a 'Find' menu option that displays the 'Element Usage' dialog. This lists the occurrences of the object and, when you select one, the diagram containing that occurrence opens with the object selected.

You can locate occurrences of:

- A Package
- An element
- An image

You can also list the:

- Extension Points of the target Use Case in an <<extend>> relationship
- Triggers associated with a Transition
- Items conveyed on an Information Flow connector
- Objects derived from an Operation

If the object:

- Occurs once only (such as in one diagram only), the object is immediately highlighted in the diagram or Browser window
- Is not used in any diagram, the 'Element Usage' dialog displays with no entries; click on the Close button to close

the dialog

- Is used in more than one diagram, the 'Element Usage' dialog lists those diagrams; either:
 - Double-click on a diagram name to open that diagram (the 'Element Usage' dialog remains open), or
 - Click on the diagram name and click on the Open button to open that diagram (the 'Element Usage' dialog closes)

The 'Element Usage' dialog defaults to showing, in order, the 'Usage Type' of the object, 'Diagram Type' and 'Diagram' columns. If you float the cursor over the right edge of the 'Diagram' column header, so that it changes to , you can drag the column border right to expose the hidden columns 'Diagram ID', 'Object ID' and 'Kind' (do this in separate passes for each hidden column).

To make the display of information easier to read, you can resize the 'Element Usage' dialog and drag the borders of the column headers to the appropriate width for the listed items. You can also click on a column header and re-sort the items in the forward or reverse alphanumeric order of the selected column content.

Locate Objects

This table provides the instructions for locating occurrences - uses - of different types of object.

Object Type	Action
Element	In the Browser window, right-click on the

	<p>element and select the 'Properties Find in all Diagrams' option.</p> <p>On a diagram, right-click on the element and select the 'Find Find in all Diagrams' option.</p> <p>Alternatively, click on the element and press Ctrl+U.</p>
Package	<p>In the Browser window, right-click on the Package and select the 'Properties Find in all Diagrams' option.</p> <p>On a diagram, right-click on the Package and select the 'Find Find in all Diagrams' option.</p> <p>Alternatively, click on the Package and press Ctrl+U.</p>
Image	<p>On a diagram, right-click on the element to which you want to assign an image and select either the 'Appearance Select Default Image' option or the 'Appearance Select Alternate Image' option. In either case, the Image Manager screen displays. Click on the required image name and on the Usage button. The 'Element Usage' dialog displays showing, in this case:</p> <ul style="list-style-type: none">• The names of the elements to which the image has already been applied

	<ul style="list-style-type: none"> • The name of the diagram on which each instance of the image has been used • The Image Manager image ID for the image (a hidden column) • The Diagram ID (DID) for each diagram (a hidden column) • The Object ID for each element on which the image has been used (a hidden column) <p>Click on an element name and on the Open button to display the diagram on which the image has been used, with that instance of the image highlighted.</p>
<p>Use Case Extension Point</p>	<p>On a diagram, right-click on the <<extend>> connector and select the 'Advanced Extension Point Set Extension Point' option.</p> <p>The 'Element Usage' dialog displays, listing the Extension Points currently assigned to the target Use Case element.</p> <p>Click on the required Extension Point and on the Open button; the dialog closes, and the <<extend>> connector shows a small circle attached to a Note element that identifies which extension point it represents.</p>

	<p>If the target Use Case has no extension points, you are prompted to create them.</p>
<p>Objects derived from an operation</p>	<p>In the Browser window, right-click on the operation and select the 'Properties Find in all Diagrams' option.</p> <p>The 'Element Usage' dialog displays, listing the Action elements and/or Sequence Message types derived from the operation in the model. For a Sequence Message, in the 'Kind' column, you can see the value of the 'Kind' property of the message.</p> <p>Double-click on an object to open its parent diagram and show the location of the object in the diagram.</p>
<p>Triggers Associated with a Transition</p>	<p>On a StateMachine diagram, right-click on the Transition connector between two States and select the 'Find Triggers Associated' option. The 'Element Usage' dialog displays, listing the Triggers assigned to the Transition. The 'hidden' column in this instance is 'GUID', showing the GUID of each Trigger element. If you double-click on a Trigger name, the system locates and highlights the Trigger element in the Browser window.</p>

<p>(Information) Items Conveyed</p>	<p>You can also use the 'Element Usage' dialog to identify and select items conveyed and/or realized on an Information Flow connector. On the diagram, right-click on the connector and select the 'Find Items Conveyed' menu option. The 'Element Usage' dialog displays, listing the items conveyed on the connector. The 'hidden' column in this instance is 'GUID', showing the GUID of each conveyed element. If you double-click on an element name, the system locates and highlights the element in the Browser window.</p>
---	---

Manage Structural Elements

In UML Modeling, you can define certain constructs and events with structural elements (also called Parts, Properties, interaction points or - in the case of Entry and Exit Points on a State element, connection points) that are added on to a parent element. For example, you can add Ports to a Class (as shown), Action Pins to an Action, or Activity Parameters to an Activity. Structural elements become a component of the parent element; certain structural elements (such as Parts and Properties) can exist independent of a parent, but do not have an independent role.

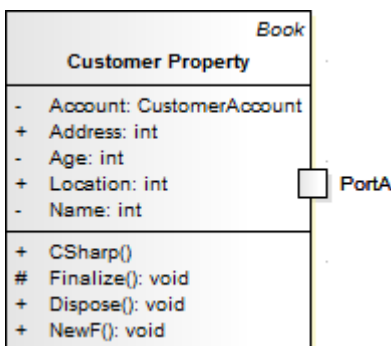

You manage structural elements through the Features window, managing Parts and Properties on the 'Parts / Properties' tab and Ports on the 'Interaction Points' tab. If the parent element is a State, its connection points are shown on the 'Connection Points' tab. All three tabs have the same options, described here.

Access

Ribbon	Start > All Windows > Properties >
--------	------------------------------------

	<p>Element Features > Features > Interaction Points</p> <p>Start > All Windows > Properties > Element Features > Features > Parts / Properties</p> <p>(For a State element, select one of the other options and then click on the 'Connection Points' tab)</p>
<p>Context Menu</p>	<p>Right-click on element in diagram Features Interaction Points</p> <p>Right-click on element in diagram Features Parts / Properties</p> <p>(For a State element, select one of the other options and then click on the 'Connection Points' tab)</p>
<p>Keyboard Shortcuts</p>	<p>Ctrl+5 > Interaction Points (for Ports)</p> <p>Ctrl+5 > Parts / Properties (for Parts and Properties)</p> <p>Ctrl+5 > Connection Points (for State elements)</p>

Review Structural Elements

Option	Action
--------	--------

list of elements	<p>Review the definition of each structural element currently associated with the selected parent element. If you select the 'Show Owned/Inherited' checkbox, the list will also include any structural elements from any classifiers that the parent element has.</p> <p>If you want any structural element to be visible on the parent element on the current diagram, select the checkbox next to that element's name. Notice that the 'Visible' column in this panel then shows the value True against the selected element.</p> <p>To hide the structural element on the diagram, clear the checkbox. The structural element still exists on the parent element, but is just not visible in the diagram.</p> <p>In the 'Type' field, you can change the assigned type if necessary. Click on the  icon and browse or search for and select the required type from the 'Select Type' dialog.</p>
All None	Click on these buttons to select (All) or clear (None) the checkboxes against all listed elements.

<p>Show Owned/Inherited</p>	<p>The tab lists the structural elements on the selected parent element. If you want to include inherited or owner properties from any classifier that the parent element might have, select this checkbox.</p>
-----------------------------	---

Context Menu options

The 'Parts/Properties' and 'Interaction Points' tabs have a context menu providing options that help you to further manage the structural elements on the parent element.

Option	Description
<p>Add New</p>	<p>Select this option to add a new structure element of the same kind (Port, Part or Property) to the parent element. The 'Insert New Embedded Element' dialog displays. In the:</p> <ul style="list-style-type: none"> • Element Type field (if necessary) click on the drop-down arrow and select the appropriate type of element (Port or Property, for example) • Name field, type in an appropriate name for the element or, alternatively, click on the Auto button to apply the automatic naming/numbering system

	<p>defined for the project</p> <ul style="list-style-type: none">• Stereotype field (if required) click on the drop-down arrow and select the required stereotype from the list• Type field, click on the  icon and browse or search for and select the required type from the 'Select Type' dialog <p>Click on the OK button to add the structural element to the parent.</p>
Redefine	<p>Click on this option to create a clone of the structure element, that you can change the properties of.</p>
Modify	<p>Click on this option to edit the properties of the selected structure element in the 'Modify Embedded Element' dialog, which has the same fields as the 'Insert New Embedded Element' dialog described in the earlier Add New table entry.</p>
Delete	<p>Click on this option to immediately remove the structure element from the model.</p>

Notes

- The name of a structural element displays on the diagram as a label, which you can edit using the 'Labels' context menu

Template Classes

If you are working with Parameterized Classes or Binding Classes, you can use the 'Templates' dialog to define:

- The Parameterized Class template parameters and
- The Binding expressions on a Binding Class

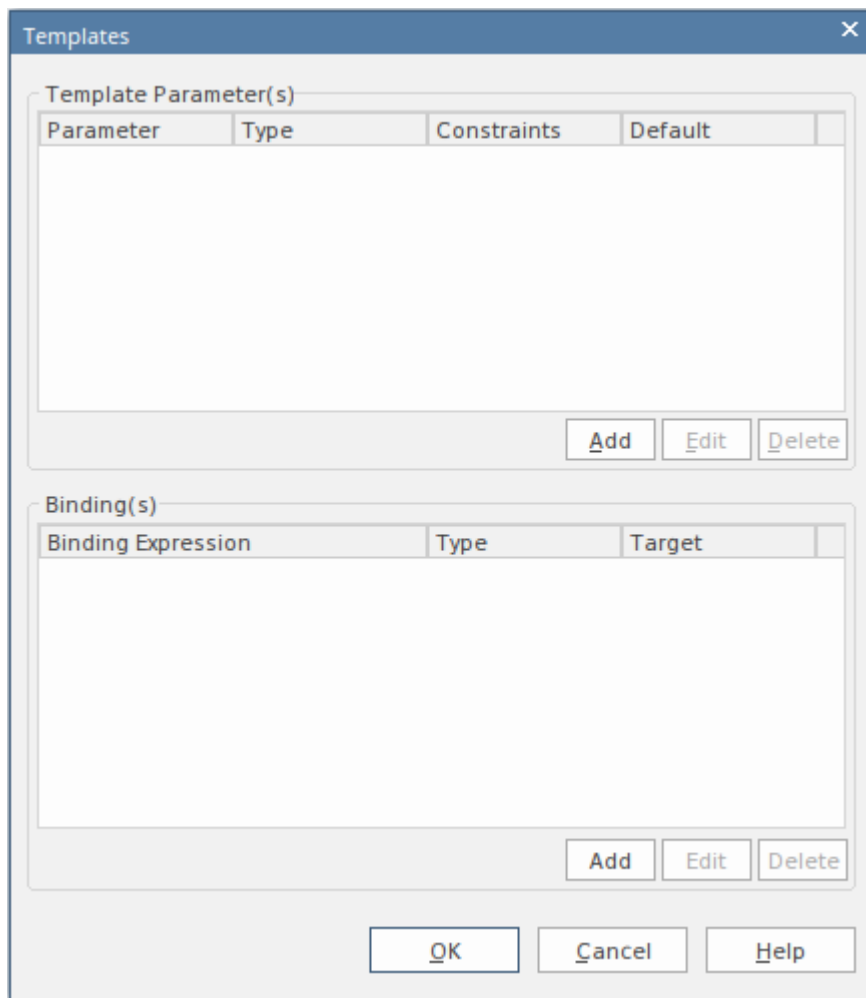

Access

Click on the appropriate Class element in the Browser window or in a diagram.

--	--

Ribbon	Design > Element > Manage > Template Parameters
Keyboard Shortcuts	Alt+5 Template Parameters

Use

In the 'Template Parameter(s)' panel, click on the Add button to add a new parameter, or click on an existing parameter and on the Edit button to edit the parameter; in either case, the 'Template Parameter' dialog displays.

In the 'Binding(s)' panel, click on the Add button to add a new binding expression or click on an existing expression and on the Edit button to edit the expression. When you click on the Add button, a short context menu displays from which you select the type of relationship to generate, and then you define the binding expressions.

If either a template parameter or a binding expression is no longer required, click on it and then click on the corresponding Delete button.

Set Element Parent

In the context of one element being generalized by one or more other elements, those other elements are referred to as the parent elements. You can define the parent element(s) for a generalizable element, or an interface it realizes (implements), using the 'Set Parents and Interfaces' dialog. The parent elements do not necessarily have to exist in the model; you can specify an element that you intend to create later. You can also delete an existing parent/child relationship using the dialog.

Access

Ribbon	Design > Element > Manage > Parents and Interfaces
Context Menu	Right-click on element in diagram Advanced Parent
Keyboard Shortcuts	Ctrl+I

Set an element parent

Option	Action
Type	<p>Click on the drop-down arrow and select the type of relationship to set (Implements or Generalizes) from the list. You select the relationship type first because, if you use the Choose button, the 'Select Classifier' dialog actually creates the relationship based on this field value, immediately when you select the parent or interface element.</p>
Class Name	<p>Either:</p> <ul style="list-style-type: none">• Type in the parent or interface name, or• Click on the Choose button to browse or search for the element within the current model (the relationship is created immediately when you select the classifier)
Accept classifier even if not in model	<p>If the parent element does not currently exist in the model, select this checkbox to protect the reference to a non-existent element.</p>
Add	<p>If you do not use the Choose button, click on this button to add the relationship to the 'Type Details' list, to the selected child element and to the model.</p>

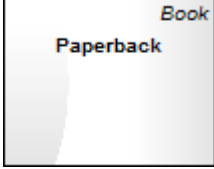
	 <p>Prior to this:</p> <ul style="list-style-type: none"> • If the parent element does not exist in the model and you have not selected the 'Accept classifier even if not in model' checkbox, an <i>Unknown Classifier</i> error message displays • If you have specified an existing element with the same name as other elements in the model, a dialog displays listing the elements and their parent Packages, prompting you to select the correct classifier
Delete selected	<p>If you no longer want to keep the relationship between a parent and child element, click on it in the Type Details panel and click on this button to remove it.</p>

Operations on the parent element

If the parent name is shown in the element, you can select it (click on the child element, then click on the parent element name) and right-click to display a context menu of further

operations:

- Apply the facilities of any relevant technology enabled in Enterprise Architect
- Redisplay the 'Set Parents and Interfaces' dialog to, for example, delete the parent or add further parents
- Display the parent element 'Properties' dialog
- Find the parent element in the Browser window
- Find the parent element in any diagram in which it exists

If the parent element does not currently exist in the model, but is shown on the child element in the diagram, you can still access the first two of the context menu options for it.

Notes

On a diagram, the parent element name is displayed in the top right corner of the child element if:

- The parent element is not on the same diagram as the child element, and
- The 'Show Hidden Parents' option is selected on the 'Diagram > Behavior' page of the 'Preferences' dialog

Composite Elements



You might want to use one element to represent a structure composed of other elements; for example, a general Use Case representing a collection of more specific Use Cases. To achieve this, you can make the 'general' element a composite element, as a pointer to a child diagram containing the 'detail' elements. The elements that you can turn into composites include Classes, Objects, Activities and Use Cases.

Access

Ribbon	<p>With an element selected in the Browser window:</p> <p>Design > Diagram > Add Diagram : Type - UML Structural UML Structural Composite Structure <one of the two diagram types></p> <p>There are several Perspective groups and Perspectives that lead you to the UML Structural group; the one provided is an example.</p>
Context Menu	<p>Right-click element in diagram New Child Diagram Composite Structure Diagram or</p>

	Right-click element in Browser window Add Composite Structure Diagram
--	---

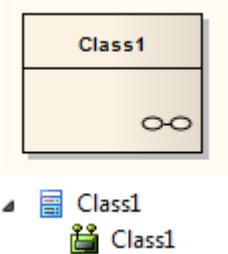
Make an Element Composite

Images	Step / Action
	<p>When you select to make an element composite, it displays in the diagram and in the Browser window as illustrated on the left.</p> <p>Note:</p> <ul style="list-style-type: none"> • The small icon in the bottom right hand corner of the element shape, indicating that this is now a composite element • The icon against the child diagram name in the Browser window, indicating that this diagram was created as a child of the composite element
	<p>To access the child diagram that the composite element points to, either:</p> <ul style="list-style-type: none"> • Double-click on the composite element in the diagram, or • Click on the composite element and press the = key

If you have selected the 'Enable Concise Diagram Navigation' checkbox on the 'Application Look' (Visual Style) dialog, the child diagram replaces the parent in the Diagram View. Otherwise the child diagram opens in a separate tab.

You can populate the child diagram with elements and connectors to represent the internal structure of the (parent) composite element. In this process, structural (embedded) elements cannot be directly added to the child diagram. However, you can add them using a different, modified procedure.

If you have selected the 'Enable Concise Diagram Navigation' checkbox, to return to the parent diagram containing the composite element click on the arrow in the right hand end of the diagram tab. If you accessed the child diagram by:

- Double-clicking on the composite element, the parent diagram displays
- Pressing the = key, the parent diagram displays with the composite element selected

The composite element and its child diagram are now represented in the Browser window as shown. ClassX, ClassY and ClassZ are elements added to

	the child diagram.
	<p>If you already have, or subsequently create, another diagram that better represents the content of your composite element, you can select that diagram as the child of the composite.</p> <p>Right-click on the composite element in its diagram and select the 'New Child Diagram Select Composite Diagram' option. The 'Select Classifier' browser displays, through which you can browse the entire project to locate the alternative diagram. Click on the diagram and on the OK button to apply it as the child of the composite element.</p> <p>Neither the original nor the alternative child diagram move location or change icons in the Browser window (unless you specifically make these changes as a separate operation).</p>

Alternative Notation

You can display the contents (the child diagram) of a Composite element in a number of other ways.

Display	Detail
----------------	---------------

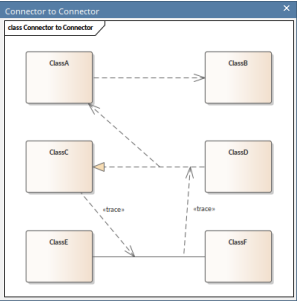
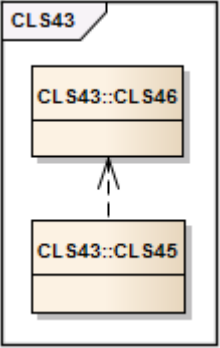
Format	
<p>Display Composite Diagram in Popup window</p> 	<p>On the parent diagram, click on the composite element and then on the 'eye' icon (👁️) off the right hand side of the element, or press the Backslash (\) key. The child composite diagram displays in a floating Popup window. To close the pop-up window, press the Backslash key again or click on a different point in the work area. Double-clicking on the floating Popup window, will open the previewed diagram in the work area.</p>
<p>Display Composite Element as Frame</p> 	<p>Composite elements can show their contents in place of their usual notation.</p> <ol style="list-style-type: none"> 1. Right-click on the composite element in the diagram; the context menu displays. 2. Select the 'New Child Diagram Show Composite Diagram in Frame' option. <p>The composite element is replaced by a frame containing the child diagram. The frame label shows the composite element name. The element is resized to contain the diagram; whilst it can be enlarged, it cannot be reduced to less than the diagram size.</p> <p>Some technologies, such as SysML,</p>

qualify the frame label to show the diagram type, element type, element name and child diagram name. If you design custom diagram profiles, you can also qualify the frame label as required.

Display Composite Element Content In Compartment

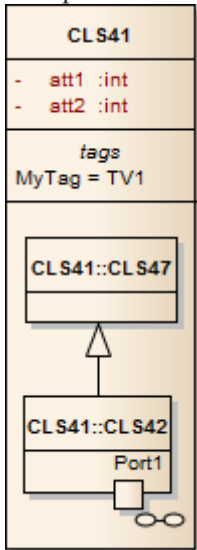

Composite elements can also show their contents in addition to their usual notation, in a separate compartment of the element.

1. Right-click on the composite element in the diagram to open the context menu.
2. Select the 'New Child Diagram | Show Composite Diagram in Compartment' option.

A compartment is added to the element, containing the child diagram. The element is resized to contain the diagram; whilst it can be enlarged, it cannot be reduced to less than the diagram size.

You can also display a Composite diagram inside its parent element using a Shape Script. The diagram is displayed in a custom compartment in the center of the element and not necessarily with the standard compartments (such as attributes, tags).

Notes

- If the 'Composite' option is not listed in the context menu, the option is not available for the type of element you have selected
- If you select either the frame or compartment options to display the child diagram on the composite element, and then you select a different child diagram, the display settings are cleared; reselect the appropriate option to display the new diagram on the composite element
- Automation support is available for Composite elements - Element has an Elements collection and a Diagrams collection; additionally you can set the Composite diagram with SetCompositeDiagram

Show Structural Elements In Composite Diagram

A Composite element shows the external relationships of the element with other components of the model and, via a child diagram, its own internal structure. You cannot normally add structural elements to the representation of this internal structure; however, this procedure describes a modified process through which you can add structural elements to the child diagram.

Structural elements include:

- ActivityParameter
- RequiredInterface
- ActionPin
- Port
- EntryPoint
- ExpansionNode
- ObjectNode
- ProvidedInterface
- ExitPoint
- Part

Include embedded elements in a child composite diagram

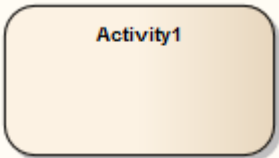
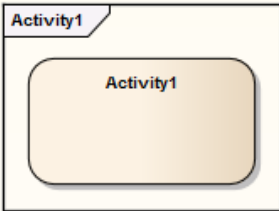
Images	Step / Action
	<p>Create the element to set as a Composite element. For example, a Class, Activity, or SysML Block.</p>
	<p>Right-click on the element in the diagram and select the 'New Child Diagram Composite Structure Diagram' option. The element redisplay with a small icon in the bottom right hand corner, indicating that this is now a Composite element.</p>
	<p>Double-click on the Composite element to access the child diagram that it points to.</p>
	<p>From the Browser window, drag the Composite element itself onto the child Composite diagram, and paste it in as a Link.</p>
	<p>Right-click on the element in the diagram, and select the 'New Child Diagram Show Composite Diagram in Frame' option. The element redisplay with a labeled frame around it.</p>

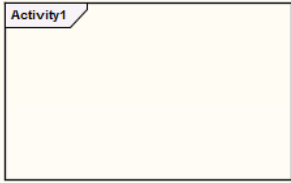
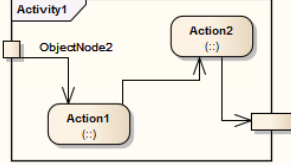
	<p>Press Ctrl+S to save the diagram.</p> <p>Right-click on the diagram tab and select the 'Reload <diagram name>' option.</p> <p>The diagram redisplay with just the frame showing. This frame represents the original composite element.</p>
	<p>Populate the frame with the appropriate internal elements, including the structured elements that attach to the frame itself.</p>

Visual Representation

Each UML element has a default representation. However, you can:

- Change the shape of the element
- Display or hide various types of information held in the element, in compartments
- Display the element in a simpler format, showing basic properties and notes but hiding features

You can also customize the appearance of single elements or all elements on a diagram to a simpler, colorful drawing style.

Compartments

When you place an element on a diagram, you can display it with a number of compartments that reveal not only the attributes and operations of the element, but also several other properties such as tags, requirements, constraints, allocated resources, discussions and reviews.

This diagram shows some of the types of compartment that you can show on an element in a diagram, as an illustration of how compartments are displayed. For a full list of standard compartments, and information on custom compartments, see the *Feature Visibility* and *Define Element Characteristics* topics.

Bodywork
<ul style="list-style-type: none"> - Base Metal: int - Primer Paint: int - Color Paint: int
<ul style="list-style-type: none"> + operatA(): void + OperatB(): void
<i>requirements</i>
Crumple Zones on front and rear
<i>constraints</i>
{Const01}
<i>tags</i>
Rear Type = Wagon Tag-Metallic Finish = Yes
<i>discussions</i>
* What is 'Metallic Finish'? Is it a value of the attribute 'Color Paint', or a separ...
<i>Bodywork includes separate door panels, bonnet, hatch or boot.</i>

Notes

- Compartments cannot be shown on elements where the appearance is defined by Shape Scripts, such as elements specific to ArchiMate or BPMN
- To set the display of each of the various compartments, see the *Feature Visibility* Help topic; the display of the compartments is also controlled through the diagram properties, on the 'Elements' tab - the specific element settings take precedence over the more general diagram settings
- Elements that do not default to rectangle notation, such as Activities or Use Cases, must have the 'Appearance | Use Rectangle Notation' context menu option turned on in order to display compartments
- Kanban diagrams do not automatically show element compartments, which contain useful and important information; however, you can use the Kanban 'Native Element Draw Style' option to show compartments on a Kanban diagram and display the information they contain

Rectangle Notation

You can display various 'shaped' elements, such as an Interface, Use Case or Actor, using rectangle notation. This notation shows on the diagram any attributes, operations or constraints belonging to the element, in the same style as for a Class.

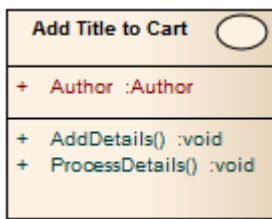

To show an element using rectangle notation, either:

- Click on the element in the diagram and on the  icon that displays on the right of the element, or
- Right-click on the element on the diagram and select the 'Appearance | Use Rectangle Notation' context menu option

This displays the element as a rectangle, by default displaying a UML keyword identifying the element type in guillemets (« ») above the element name. However, certain elements such as Activities and Use Cases by default define an icon of the 'normal' shape instead of the keyword, and display the icon in the top right-hand corner of the element. On a Construction diagram, an Actor element also defaults to rectangular notation.

The setting only applies to the selected element, and can be toggled on and off either by:

- Clicking on the  icon again, or

- Deselecting the context menu option or
- Selecting the reciprocal context menu option such as 'Use Circle Notation' or 'Use Actor Notation'

Info View Style

Info View is an alternative notation to display a simplified view of an element that allows the name, description and selected other properties to be displayed for an element instead of the normal notation showing child features. This view allows a diagram to be constructed for a non-technical audience or any purpose where display of descriptions is more important than the notations defined by the modeling language.

For example, a database engineer will normally need to see the columns and indexes of a Table, while a manager might be more interested in seeing a high level description relating to each table.

Access

Context Menu	On diagram, right-click element Appearance Enable Info View On diagram, right-click element Appearance Info View Properties
--------------	--

Description

When you enable Info View on an element, the element is rendered as a rounded rectangle, divided into two. In the:

- Top half, on the left, the element name, type and stereotype display; on the right a small icon of the element's native shape displays
- Bottom half, at least some of the element's notes display

If there are more notes than can show in the available space, an ellipsis (...) displays at the end of the visible text, in which case you can expose more of the notes text by dragging the 'expansion handles' to resize the element. (Under Linux, the Notes text displays outside the element boundary.)

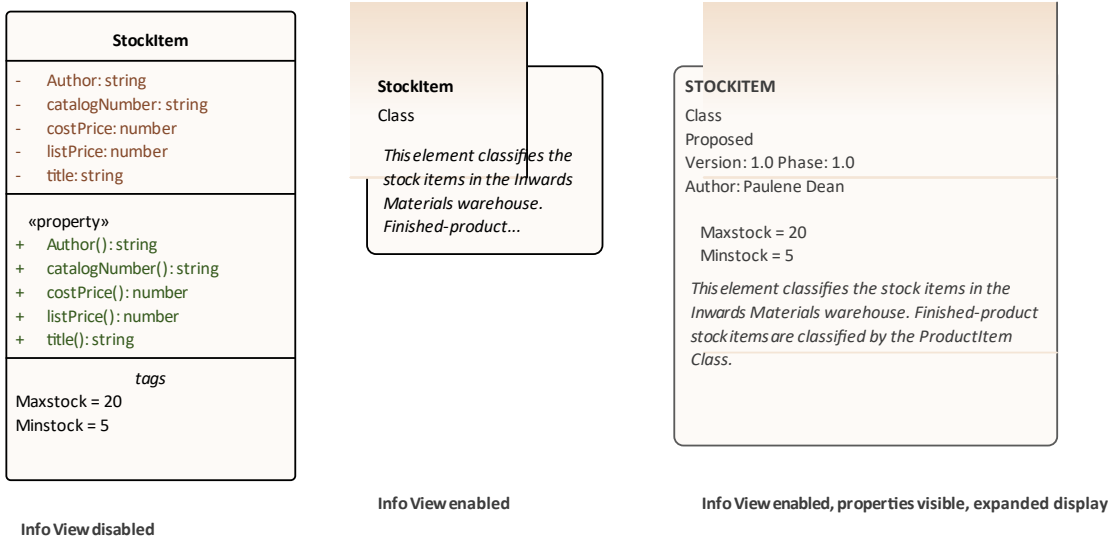

Notes might not be shown on the original rendering (as in the illustration), but automatically show when Info View is enabled. They display in italics but otherwise reflect any formatting applied to the Notes in the element. You can deselect an Info View Properties Class option to hide the notes.

The element has a minimum size; you cannot drag the element any smaller than that. However, if you reduce the element to the minimum size in Info View, when you select the 'Enable Info View' option again to turn Info View off,

the element returns to its original size to display all of its visible content.

The properties listed in the top left of the element are customizable. The list defaults to show the element type and stereotype (where a stereotype exists) but you can choose to hide one or both of those properties, and to show any or all of the element Phase, Version, Status, Author and (for an element in the Requirement group) Priority. Those five properties are not shown on the element when Info View is disabled. You can also hide the native-shape icon on the element, display the element name in capitals, and display the element's Tagged Values and/or Maintenance compartments while in Info View (each compartment must also be enabled in either the diagram 'Properties > Elements' page or the element 'Compartment Visibility' dialog).

To customize the properties shown:

1. Right-click on the element and select the 'Appearance | Info View Properties' option; the 'Visible Properties' dialog displays.

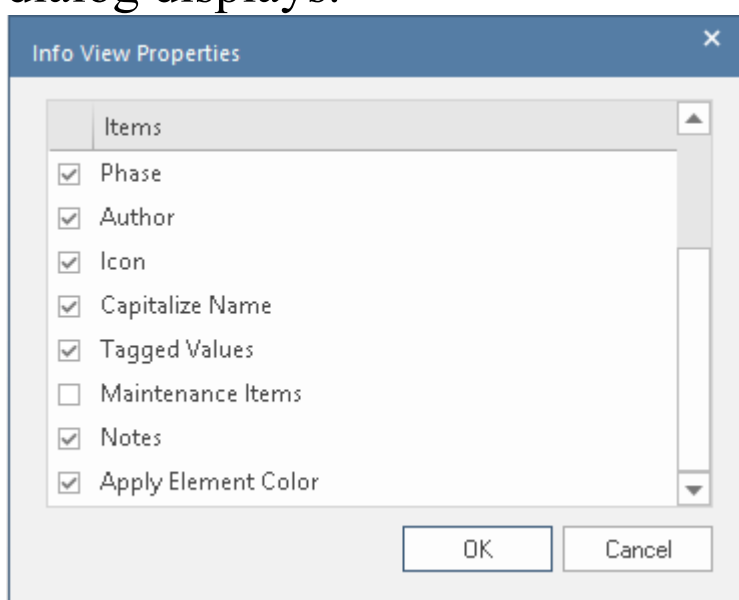

2. Select the checkbox against each property to display, and clear the checkbox against each property to hide.
3. Click on the OK button.

Notes

- The 'Info View' element icons reflect the fill and line colors of the original elements; if the 'Use Element Group Style' option is selected on the 'Diagram > Appearances' page of the 'Preferences' dialog (select the 'Start > Appearance > Preferences > Preferences' ribbon option) these will be the colors assigned to each element type, otherwise they will be the standard element fill and line colors; any default appearance colors assigned to the native shape element can be applied to the Info View by selecting the 'Apply Element Color' checkbox
- The Info View style is not compatible with the Custom Diagram Style; you don't apply both styles to the same element

Element Property Displays

Enterprise Architect provides a number of ways to define, assign and review the properties and features of elements, each offering different facilities more suited to one aspect or another of model development.

User interface screens for accessing element properties

Screen

'Properties' dialog - the element 'Properties' dialog defines both the general properties of an element such as its name, phase, version and status, and properties specific to the element type such as Table columns, Activity behaviors and Chart format.

Element Properties Window - this window displays the general properties of the currently-selected element in a single view. You can dock the window within the Enterprise Architect workspace or have it free-floating within or outside the workspace.

Details tab of the Inspector window - the 'Details' tab presents all of the existing add-on properties of an element in a folder structure, through which you can create further property objects, operate on them, and

delete them.

Responsibility window - this window provides a convenient method of quickly adding, viewing, editing and deleting rules applied to an element. The window shows details of the requirements, constraints, scenarios and files that impose such rules or restrictions on the element.

'Select <Item>' dialog - This dialog is a multi-purpose browser and search tool for locating model items such as Classifier elements, properties, attributes and behaviors. The '<Item>' in the dialog title changes to represent the type of object the original operation is working on.

Properties Dialog

The element 'Properties' dialog helps you to define and review a wide range of properties of a selected element. For a Class, these properties include:

- General settings, such as name, notes, alias, stereotype (if any), version, scope, dates created and modified, and status
- Details such as cardinality, concurrency and features (attributes and operations) owned
- Advanced, or custom, properties that you can edit
- Tagged Values assigned to the element
- Technology-specific Tagged Values grouped on a separate tab
- Requirements associated with the element, both internal (responsibilities) and external
- Constraints on the element's actions
- Scenarios under which the element operates
- External files associated with the element
- Links (relationships or connectors) in which the element is the source or target

These properties are presented on either a main tab of the 'Properties' dialog or a secondary tab in the panel at the right of the dialog.

Access

On a diagram or in the Browser window, select an element and:

Ribbon	Design > Element > Editors > Properties Dialog
Context Menu	Right-click on element Properties Properties
Keyboard Shortcuts	Alt+Enter Shift+Enter
Other	On the Properties window for an element, click on the  icon

Buttons

On any tab of the 'Properties' dialog, at any time, you can click on the buttons at the foot of the dialog and save or clear your changes.

Button	Action
OK	Click on this button to save your changes and close the 'Properties' dialog.
Cancel	Click on this button to abort your changes and close the 'Properties' dialog.

Apply	<p>Click on this button to save your changes and keep the 'Properties' dialog open, so that you can continue working.</p> <p>It is a good idea to click on this button when you have finished working on a tab and are just about to move on to another tab.</p>
Help	<p>Click on this button to display the Help topic for the tab you are currently working on.</p>

Notes

- There are several variations of the 'Properties' dialog:
 - The dialog for a Table or Stored Procedure element has slight differences on the 'General' tab, and a 'Table Details' (or 'Stored Procedure Details') tab instead of a 'Details' tab
 - The dialog for a Class element of a stereotype other than Table is as shown in the *General Settings* topic
 - The dialog for an element of any type other than Class does not have a 'Details' tab
 - System Boundaries have a single 'Properties' tab on which you define the element appearance
 - The 'Properties' dialog for Wireframe elements

automatically opens to either a main 'Wireframe' tab on which you can edit the element rendering directly, or a second-level 'Wireframing Tagged Values' tab (from the General tab) if you define the element rendering by editing the XML for the properties of that element type

- In all cases, the 'Properties' dialog is expandable; you can enlarge it for adding longer entries and clearer reading of the text field values
- The 'Responsibilities' tabs - 'Requirements', 'Constraints', 'Scenarios' and 'Files' - are the detailed definition screens for the Responsibility window and can be accessed from it
- The 'Tags' tab of the 'Properties' dialog provides facilities to create and edit Tagged Values on the object
- If Tagged Values have been derived from a stereotyped element in a Profile, they are listed on a separate tab having the Profile name
- An Object element will show the properties of its classifier, some of which are changed to represent this specific instance of the classifier

General Settings

The 'General' tab of the element 'Properties' dialog provides the name of the element and any notes that are recorded on it. To the right of the tab are subordinate tabs, the number and type of which depend on the type of element selected. For a Class element, those tabs are:

- 'Main' - defining additional identification and status properties, as described here
- 'Details' - defining the cardinality, concurrency and features (attributes and operations) of the element
- 'Advanced' - defining any high-level properties of the element that might exist; the properties are a function of the element type, and you do not add or remove them but just reset their values
- 'Tags' - defines the Tagged Values of the element; any Technology-specific Tagged Values are grouped on a separate tab

Access

On a diagram or in the Browser window, select an element and:

Ribbon	Design > Element > Editors > Properties Dialog
Context	Right-click on the element and select the

Menu	'Properties Properties' option
Keyboard Shortcuts	Shift+Enter Alt+Enter

General Options & Main tab

Different types of element might have these fields in different sequences.

Option	Action
Name	<p>This field displays the element's name which, for a new element, defaults to either:</p> <ul style="list-style-type: none"> • <code><element type><number of elements of this type already in the Package></code> (for example, <code>Class3</code>) or • A name conforming to the auto-naming/numbering convention you have defined <p>If necessary, overwrite the default name with a different name.</p>
Notes	<p>Type in or edit any notes text associated with the element, applying any notes facilities required such as hyperlinks or Glossary terms.</p>

	You can format the notes text using the Notes toolbar at the top of the field.
Stereotype	(Optional) Type the name of a stereotype for the element, or click on the  button to the right of the field and use the 'Stereotypes for <object name>' dialog to select one.
Alias	(Optional, for elements other than an Object element) Type in an alias or alternative display name for the element.
Status	Click on the drop-down arrow and select the appropriate element management status (such as Approved or Proposed).
Type	For a Requirement element, defines the requirement type. You can change the type by clicking on the drop-down arrow and selecting a new type from the list.
Role	(Optional, for an Object element) Type in the role played by the object represented by the element.
Keywords	(Optional) Type in any significant terms that the element might be associated with and that might be filtered on to identify

	the element in Use Case Metrics and Searches.
Author	This field defaults to the user ID of the person who created the element. If necessary, you can type in a different user ID, or click on the drop-down arrow and select one.
Complexity	<p>Click on the drop-down arrow and select the appropriate development complexity (used for project estimation). You normally select from three levels:</p> <ul style="list-style-type: none"> • Easy • Medium • Difficult <p>You can change your user defaults to add 'Extreme' and 'Unknown' to this list of options.</p>
Difficulty	<p>An estimate of the difficulty in meeting the Requirement, Feature, Change or Issue defined by the element; select from:</p> <ul style="list-style-type: none"> • Low • Medium • High
Priority	The relative importance of meeting this

	<p>Requirement, Change, Issue or Feature compared to other elements of the same type; select from:</p> <ul style="list-style-type: none"> • Low • Medium • High
Language	<p>Defaults to the programming language defined for the model (in the 'Default Language for Code Generation' field on the 'Source Code Engineering' page of the 'Preferences' dialog).</p> <p>If this element is required to have a different language, click on the drop-down arrow and select it. If the element is not language-specific, select '<none>'.</p>
Version	<p>Defaults to the value defined in the 'Object Display' options, for the version of the current element.</p> <p>If necessary, type over the field with a different version number or code.</p>
Phase	<p>Defaults to the value defined in the 'Object Display' options, for the phase this element is to be implemented in (for example: 1, 1.1, 2.0, ...).</p>

	If necessary, type over the field with a different phase number or code.
Package	Identifies the parent Package of the selected element.
Created	Displays the date and time the element was created.
Modified	Displays the date and time the element was most recently modified.

Details

The 'Details' tab of a Class element 'Properties' dialog helps you to define the structural and processing details for the selected element, and provides direct access to the Features window for defining attributes and operations in the element.

Access

On a diagram or in the Browser window, select an element and:

Ribbon	Design > Element > Editors > Properties Dialog > General > Details
Keyboard Shortcuts	Alt+Enter > General > Details
Other	Double-click on element : General > Details

Set element details

Option	Action
	Click on the drop-down arrow and select

Persistence	the appropriate value (blank, persistent or transient).
Multiplicity	<p>Click on the drop-down arrow and select the number of instances of the element that can exist - the value displays on the element in a diagram, in the Name compartment.</p> <p>The format of the options in the selection list is defined in the 'Cardinality' tab of the 'UML Types' dialog.</p>
Scope	Click on the drop-down arrow and select the element's scope ('Public', 'Private', 'Protected', 'Package').
Abstract	Select the checkbox to identify the element as being abstract.
Is Root	Select the checkbox to identify the element as being a root element that cannot be descended from another element.
Is Leaf	Select the checkbox to identify the element as being final, so it cannot be a parent for other elements.
Is	Select the checkbox to identify the

Specification	element as being a specification.
Is Active	Select the checkbox to identify the element as being an Active Class.
Concurrency	Select the appropriate radio button to identify how concurrent Activities should be processed: Sequentially, Guarded, Active or Synchronous.
Collection Classes	<p>Click on this button to define the Collection Classes (for generating code from Association relationships) that apply to this Class only, as the source in an Association relationship where the target role has a multiplicity of 1 or more.</p> <p>This setting overrides the default for the programming language of the Class, set in the 'Preferences' dialog.</p> <p>The 'Collection Classes for Association Roles' dialog displays.</p>
Attributes	<p>Click on this button to define the attributes for the Class.</p> <p>The Features window displays, showing the 'Attributes' tab.</p>
Operations	Click on this button to define the operations for the Class.

	The Features window displays, showing the 'Operations' tab.
Classifier Behavior	(For a Class, SysML Block or SysML Internal Block element, this field is enabled if the element has a child Interaction, StateMachine or Activity element.) Click on the  icon and select the child element, to indicate that the execution of the element and its diagram define the behavior of the classifier. On the element on a diagram, note that the classifier behavior is indicated by its own compartment of the element.

Notes

- When launched from an MDG Technology, the Attributes button and Operations button are not available

Advanced Properties

The 'Advanced' tab displays the advanced properties of the element (where they exist). You can reset the values of these properties.

Access

On a diagram or in the Browser window, select an element and:

Ribbon	Design > Element > Editors > Properties Dialog > General > Advanced
Keyboard Shortcuts	Alt+Enter > General > Advanced
Other	Double-click on element : General > Advanced

Set a value for an advanced (or custom) property

Step	Action

1	Click on the data field to the right of the property name.
2	Depending on the property, either: <ul data-bbox="277 461 1414 770" style="list-style-type: none">• Type the value in free text• Click on the drop-down arrow and select the value from the list, or• Click on the  button and search for the required value
3	Click on the Apply button.

Links

The 'Links' tab of the element 'Properties' dialog provides a list of all relationships that the current element is a partner in.

Access

On a diagram or in the Browser window, select an element and:

Ribbon	Design > Element > Editors > Properties Dialog > Links
Keyboard Shortcuts	Alt+Enter > Links Shift+Alt+L
Context Menu	Right-click on the element > Properties > Special Action

Links Facilities

Facility	Detail
Relationship Features	The 'Relationships' panel lists the relationships this element has, showing

	<p>the:</p> <ul style="list-style-type: none"> • Elements that this element is related to • Stereotype (if any) of each related element • Type of each related element • Type of each connection or relationship • Stereotype (if any) of the connector
<p>Relationship Editing</p>	<p>On the 'Relationships' panel you can right-click on a relationship to display the context menu and select to perform these operations:</p> <ul style="list-style-type: none"> • Display the 'Properties' dialog for a relationship - click on the 'Relationship Properties' option • Highlight the related element in the Browser window - click on the 'Locate Related Element' option • Delete the relationship from the model and all diagrams - click on the 'Delete relationship' option; when the system prompts you to confirm the deletion, click on the Yes button to do so <p>If you have selected the element from an open diagram, another pair of context menu operations are supported:</p> <ul style="list-style-type: none"> • Hide the relationship on the open diagram - click on the 'Hide Relation'

	<p>option</p> <ul style="list-style-type: none">• Show a relationship that is hidden on the open diagram - click on the 'Show Relation' option
--	--

The Features Window

The Features window is a versatile and seamless tool for creating and editing the features of the selected element. The window has a number of tabs that help you to view, create, delete and manage:

- Attributes
- Operations and, for State elements, operation behaviors
- Reception elements
- On a State element, Internal Triggers
- Structural elements, such as the Parts and Properties added to elements
- Edge-mounted elements (Interaction Points) such as ActionPins and Ports that form the primary interaction points of complex, composite elements
- Entry Points and Exit Points (Connection Points) on a State element

The Features window can be used in combination with the Properties window and Notes window to define some or all of the properties of a feature and, depending on the parent element type, a range of other windows such as the 'Details' tab of the Inspector window and the Responsibility window. All these windows automatically refresh to show the information for the object you have just clicked on, and you can flow between them without opening and closing them. You can very quickly define a range of properties, features and characteristics for an element, and equally quickly work through a number of elements to define a structure in the

model.

Parts, Properties, Interaction Points and Connection Points are maintained in the same way and are therefore all documented as Structural elements.

Access

Ribbon	Start > Application > Design > Details > Features Design > Element > Editors > Features > Features
Context Menu	Right-click on object > Features > All Features
Keyboard Shortcuts	Ctrl+5, F9 (Attributes), F10 (Operations)

Responsibilities

The Responsibility window provides a convenient method of quickly identifying, creating and deleting rules applied to an element. The window shows the name and main properties of the entities that impose such rules or restrictions on the element, namely the element's:

- Internal and external requirements
- Internal constraints (not external Constraint notes)
- Scenarios
- Files

Each entity type is listed on a separate tab of the window.

The Responsibility window is typically used to examine Use Case and Test Case elements, and any other elements that realize an internal Requirement.

Access

Select the element in the Browser window or diagram and select one of these options to display the Responsibility window:

Ribbon	Design > Element > Properties > Responsibilities > <entity type> Start > All Windows > Properties > Responsibilities > Responsibilities
Context	In the Browser window or on a diagram:

Menu	Right-click on the required element Properties Responsibilities
Keyboard Shortcuts	Ctrl+4 > <entity type> Alt+1 Responsibilities Alt+5 Responsibilities

The Requirements Tab

On the 'Requirements' tab you initially create the internal requirements of the selected element. If an internal requirement later proves to have broader scope, you can select a context menu option to convert it to an external Requirement element.

To add a requirement to the element, overtype the *Add Requirement* text with the name of the requirement, and then tab across the 'Status' and 'Priority' fields. These fields immediately default to 'Proposed' and 'Medium'; if you want to change either value immediately, click on the drop-down arrow at the right of the field and select the required value.

If you right-click on an internal requirement name, a context menu displays providing these options:

- Add New - to open the 'Requirements' page of the element's 'Properties' dialog, where you can define the requirement
- Modify Selected - to again open the 'Requirements' page of the element's 'Properties' dialog, where you can add or

change the details of the requirement

- Move External - to display the 'Find Package' dialog, on which you locate a Package to hold the new external Requirement element
- Delete - to delete the requirement from the element; a prompt displays to confirm the deletion

If, however, you click on an external Requirement name, only two options are enabled, to locate the element either in the Browser window or in diagrams.

The Constraints Tab

On the 'Constraints' tab you can create the constraints of the selected element and set them in a required sequence.

To add a constraint to the element, overtype the *Add Constraint* text with the name of the constraint, and then tab across the 'Type' and 'Status' fields. These fields immediately default to 'Invariant' and 'Approved'; if you want to change either value immediately, click on the drop-down arrow at the right of the field and select the required value.

If you right-click on a constraint name, a context menu displays providing these options:

- Add New - to open the 'Constraints' page of the element's 'Properties' dialog, where you can define the constraint
- Modify Selected - to again open the 'Constraints' page of the element's 'Properties' dialog, where you can add or change the details of the constraint
- Move Up and Move Down - to move the selected

constraint into a different point in the list of constraints

- Delete - to delete the constraint from the element; a prompt displays to confirm the deletion

Moving Requirements and Constraints between elements

A requirement or constraint you define for one element might be usefully moved to another if, for example, you are moving your model through stages in a lifecycle or, indeed, modeling a lifecycle. It is possible to simply drag the requirement or constraint from either the appropriate tab of the Responsibility window or the 'Details' tab of the Inspector window, onto a different element on a diagram.

From the Browser window, open the diagram containing the target element, then click on the element from which to move the requirement or constraint. It is convenient to have both source and target elements on the same diagram, but it is possible to select the source element in the Browser window or on a different open diagram.

It is also convenient to have compartments enabled on the target element, with the 'requirement' and/or 'constraints' compartments selected, so that you can observe the addition of the moved item. (Right-click on the element and select 'Compartment Visibility', then select the 'Requirements' and 'Constraints' checkboxes.)

Click on the item that you intend to move, and simply drag it onto the target element. The item name will display in the

appropriate compartment of that element. What you would observe might resemble this illustration.

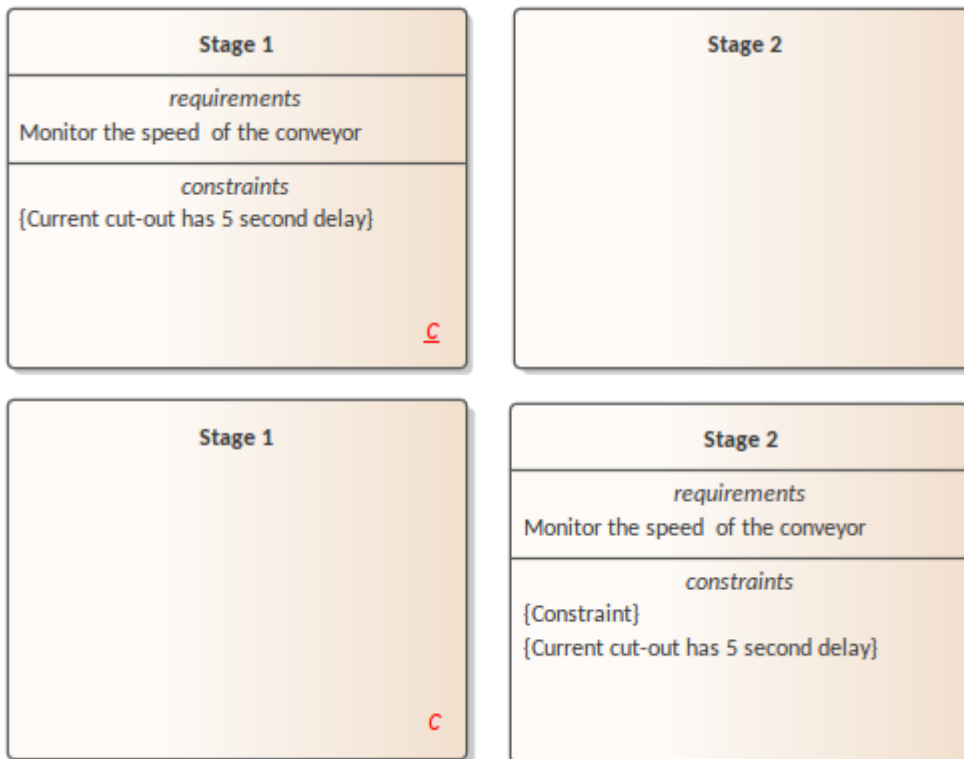

The Scenarios Tab

On the 'Scenarios' tab you can create the scenarios of the selected element. The first scenario you create here defaults to the Basic Path, and subsequent scenarios default to Alternate Paths. You cannot change the path type here, but if you edit the scenario elsewhere the tab reflects any changes you have made.

To add a scenario to the element, overwrite the *Add Scenario* text with the name of the scenario. When you click off the name, the 'Type' field is automatically set, and the 'Structured Scenario' field is populated with an Edit button. To add details of the scenario steps, click on the Edit button

to display the Scenarios view for the element - this is identical to the 'Scenarios' page of the 'Properties' dialog for the element.

You can add a description of the scenario using the Notes window; the 'Notes' field for the scenario is then updated with that text.

If you right-click on a scenario name, a context menu displays providing the option to delete the scenario. If you select this option, a prompt displays to confirm the deletion.

The Files Tab

On the 'Files' tab you can link to one or more files external to the repository. To link a file to an element, use the 'Add New' context menu.

If you right-click on a file name, a context menu displays providing these options:

- Add New - to open the 'Files' page of the element's 'Properties' dialog, where you can create a link to the file
- Modify Selected - to again open the 'Files' page of the element's 'Properties' dialog, where you can add or change the details of the file
- Launch File - to open the file and read its content
- Delete - to delete the file from the element; a prompt displays to confirm the deletion

Requirements

Requirements are of two types:

- Internal requirements (responsibilities) and
- External requirements (system requirements, elements connected to the current element by - for example - Realize connectors)

This topic focuses on internal, responsibility requirements, although once you have created a responsibility you can convert it to an external Requirement element.

To create the requirements that an element is being designed to meet, you can use either the 'Requirements' tab of the Responsibility window or the different 'Requirements' tab of the element's 'Properties' dialog. The Responsibility window helps you to sketch out the element's internal requirements, and you can switch from there to the 'Properties' dialog to add detail to the requirement. Alternatively, you can create new internal requirements directly in the 'Properties' dialog.

You can show the internal requirements for an element on a diagram, using the element 'Compartment Visibility' function; it is also possible to show inherited requirements in this way.

Information on using the Responsibility window is provided in the *Responsibilities* Help topic. This *Requirements* topic goes on to discuss the 'Requirements' tab of the element 'Properties' dialog.

Access

On a diagram or in the Browser window, select an element and:

Ribbon	<p>Design > Element > Editors > Requirements Right-click on a requirement > Add New or Modify Selected</p> <p>Design > Element > Editors > Properties Dialog > Requirements</p>
Context Menu	<p>Right-click on element Properties Responsibilities > Requirements Right-click on a requirement > Add New or Modify Selected</p> <p>Right-click on element Properties Properties > Requirements</p>
Keyboard Shortcuts	<p>Ctrl+4 > Requirements (tab of the Responsibility window)</p> <p>Shift+Enter > Requirements ('Properties' dialog)</p> <p>Shift+Alt+R ('Properties' dialog)</p>

Define internal Requirements

Field/Button	Action
--------------	--------

Requirement	<p>Type in the name and/or short definition of the requirement.</p> <p>This text will display on the element on a diagram, if the visibility is set to show internal requirements.</p>
Properties	<p>In this panel, click on the value field against each property, then click on the drop-down arrow and select the appropriate setting:</p> <ul style="list-style-type: none">• Status - select the current status of the requirement• Difficulty - select the value that most closely reflects the difficulty of implementing the current requirement• Priority - select the value that best indicates how urgent the requirement is• Stability - select the value that provides the best indication of the probability of the requirement - or understanding of the requirement - changing; high stability indicates a low probability of the requirement changing• Type - select the value that most accurately reflects the type or function of the requirement; Functional requirements are things that the system must do, such as identify franked,

	<p>unfranked and total credit for a dividend; Non-functional requirements are things that the system must be, such as reliable or cost effective</p> <p>The 'Last Updated' field shows the date on which the requirement was last changed and saved.</p>
Notes	<p>Type in any additional details or comments on the internal requirement. You can format the notes text using the Notes toolbar at the top of the field.</p>
New	<p>Click on this button to clear the fields or set them to default values, so that you can create a new internal requirement.</p>
Save	<p>Click on this button to save your changes to the currently-selected requirement.</p>
Delete	<p>Click on this button to delete the requirement currently selected in the 'Requirements' list.</p> <p>A prompt displays to confirm the deletion.</p>
Requirements	<p>Lists the names of the requirements associated with the current element.</p> <p>Both internal and external requirements</p>

are listed on the right of the dialog; the external elements are identified by the word 'Yes' in the 'External' column.

If you want to convert an internal requirement to an external Requirement element, right-click on the requirement in the list and select the 'Move External' menu option.

Right-clicking on an external Requirement element name provides the options to locate the element in the Browser window or in any diagrams that contain it.

External Requirements

External Requirements are those Requirement elements that have been connected to the current element using a Realization connector. By creating the connector from the element to the Requirement, you create an expectation that the element must implement the requirement as part of the system solution.

In Enterprise Architect, linked Requirement elements are listed in the Responsibility window and on the 'Requirements' tab of the source element's 'Properties' dialog, and from there they can be located by right-clicking on the name and selecting either the 'Find in Project Browser' option or 'Find in Diagrams' option.

External Requirements are also shown in the 'Links' tab of the 'Properties' dialog for the element, and again can be located in the Browser window by right-clicking on the external Requirement in the list and selecting the 'Locate Related Element' option.

When an external Requirement is highlighted in the Browser window or in a diagram, its properties are displayed in the Properties window (press Ctrl+2 to display this window if it is not open).

Constraints

If you need to define the conditions and rules under which an element operates and exists, you can do this by setting Constraints on the element, in conjunction with its responsibilities (internal requirements). Typical constraints are pre- and post-conditions, which indicate things that must be true before the element is created or accessed and things that must be true after the element is destroyed or its action is complete.

To create the constraints on an element, you can use either the 'Constraints' tab of the Responsibility window or the different 'Constraints' tab of the element's 'Properties' dialog. The Responsibility window helps you to sketch out the element's constraints, and you can switch from there to the 'Properties' dialog to add detail to the constraint.

Alternatively, you can create new constraints directly in the 'Properties' dialog.

You can show the constraints for an element directly on the diagram, using the element 'Compartment Visibility' function; this also reveals any constraints inherited from parent elements.

Information on using the Responsibility window is provided in the *Responsibilities* Help topic. This *Constraints* topic goes on to discuss the 'Constraints' tab of the element's 'Properties' dialog.

Access

On a diagram or in the Browser, select an element and:

<p>Ribbon</p>	<p>Design > Element > Editors > Constraints Right-click on a constraint > Add New or Modify Selected Design > Element > Editors > Properties Dialog > Constraints</p>
<p>Context Menu</p>	<p>Right-click on element Properties Responsibilities > Constraints Right-click on a constraint > Add New or Modify Selected Right-click on element Properties Properties > Constraints</p>
<p>Keyboard Shortcuts</p>	<p>Ctrl+4 > Constraints (tab of the Responsibility window) Shift+Enter > Constraints ('Properties' dialog) Shift+Alt+C ('Properties' dialog) Alt+9 > Constraints : Shift+Enter</p>

Define constraints for an element

Option	Description
Constraint (field)	

	Type the name or value of the constraint.
Type	Click on the drop-down arrow and select the appropriate type (Pre-condition, Post-condition, Process, OCL or Invariant).
Status	Click on the drop-down arrow and select the appropriate status.
Notes	Type in any additional details or comments on the constraint. You can format the notes text using the Notes toolbar at the top of the field.
New	Click on this button to clear the fields ready to create a new constraint.
Save	Click on this button to save the constraint data.
Constraint (panel)	This field lists the constraints defined in the element, by name.
Delete	Click on a constraint in the 'Constraint' list and click on this button to immediately remove the constraint from the element.
(Up and Down Hands)	



(If you have two or more constraints in the element.) Click on a constraint in the 'Constraints' list and click on one of these buttons to move the constraint one position up or down in the list.

Scenarios

A scenario is a real-world sequence of operations that describes how the process represented by an element works in real-time. Scenarios can be created for any element - although they principally apply to Use Cases - to describe functional behavior, business workflows and end-to-end business processes.

You define scenarios in detail in the Scenarios View, creating new scenarios or editing existing scenarios; for each scenario you can then:

- Create a series of steps for each part of the scenario
- Structure the scenario to show how the basic path diverges into alternate paths and exception paths
- Generate a number of types of diagram from the structure
- Generate the structured scenario from an Activity diagram
- Generate the structured scenario from text on the clipboard

You can also create and review scenarios at two less-detailed levels, using:

- The 'Scenarios' tab of the Responsibility window to create an empty basic or alternate scenario, or to simply list the scenarios for an element
- The 'Scenarios' tab of the element 'Properties' dialog to create scenarios, add, edit and format Notes, change the path type or change the sequence

Locating Scenarios

To help you locate the elements for which scenarios have already been defined, you can run the predefined 'Find Scenarios' Model Search.

Select the 'Design > Element > Properties > Find Scenarios' ribbon option to automatically execute the search on the model, which displays a list of the elements that contain scenarios.

You can either double-click on an element or right-click on it and select the 'Properties' option, to display the 'Properties' dialog for that element. Select the 'Scenarios' tab of the dialog.

Notes

- The Scenarios displays do not prevent you from creating more than one basic path for the scenario on an element, but it would be unusual to define more than one

Scenarios - Responsibility Window

The 'Scenarios' tab of the Responsibility window is the simplest of the three screens on which you can create and manage scenarios for an element.



You use this tab to create a Basic Path scenario or, if a Basic Path already exists, an Alternate Path scenario. The tab also simply lists the existing scenarios on an element, and provides options to edit or delete any of these scenarios.

Access

On a diagram or in the Browser window, click on the element and:

Ribbon	Design > Element > Editors > Responsibilities > Scenarios
Context Menu	Right-click on element Properties Responsibilities > Scenarios Inspector window > Details Scenarios (right click) Scenario List
Keyboard Shortcuts	Ctrl+4 > Scenarios Alt+5 Scenarios

Create a Scenario

In the 'Scenario' column, click on the *Add Scenario* text and type in a name or title, then click away from the item line.

If this is the first scenario on the element, it is automatically created as the Basic Path; subsequent scenarios are automatically created as Alternate paths. You cannot change these allocations on this tab.

Alternatively, right-click on the *Add Scenario* text and select the 'Add New' option. The 'Scenarios' tab of the element 'Properties' dialog opens. See the *Scenarios Tab - Properties Dialog* Help topic.

Review Scenarios

Where there are existing scenarios, the 'Scenarios' tab lists them in the order in which they were created (or in the order they have been reorganized into on a different screen). You can see any notes that have been written elsewhere for each scenario, and the type of each scenario. To display the full text of the notes, hover the cursor over the 'Notes' field.

Alternatively, if the Notes window is open you can read and edit the note text there.

You can edit the scenarios in one of two ways.

- Right-click on the scenario line and click on the 'Modify Selection' option to display the 'Scenarios' tab of the

Properties window, if you want to:

- Put the scenarios in a different sequence
 - Add or edit Notes text
 - Change the scenario name and/or path type
- Click on the Edit button in the 'Structured Scenario' column to display the Scenarios View, if you want to:
 - Put the scenarios in a different sequence
 - Change the scenario name and/or path type
 - Add or delete steps in the scenario, or re-sequence them
 - Link the Alternate and Exception paths to specific steps of the Basic path
 - Manage the elements that the scenario uses at various steps
 - Generate diagrams or Test Cases from the scenario

Delete Scenarios

If you no longer want to keep a scenario for an element, click on the scenario name and either select the 'Delete' option or press Ctrl+Delete. A prompt displays to confirm the deletion.

Scenarios - Properties Dialog

The 'Scenarios' tab of the element 'Properties' dialog enables you to create and delete basic definitions of scenarios for the selected element, add descriptions in the 'Notes' field, and re-arrange the Basic, Alternate and Exception Scenario paths in a list.

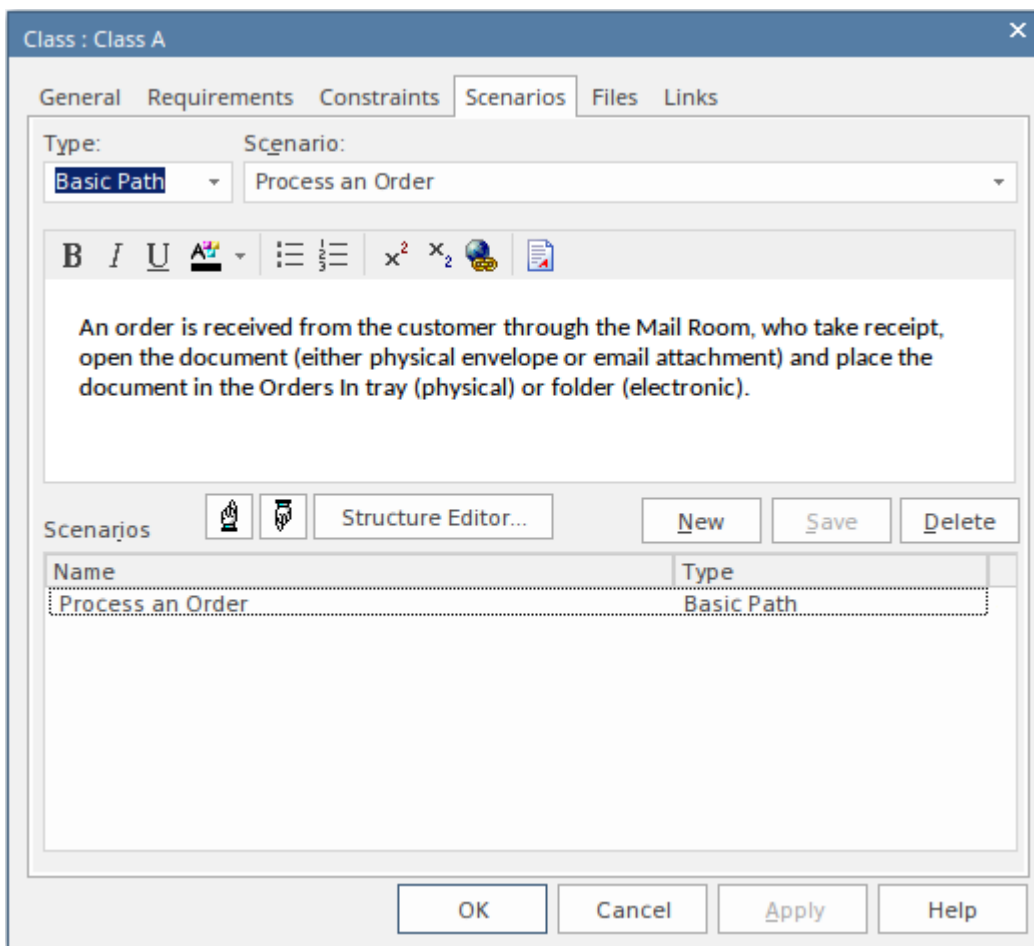

Access

On a diagram or in the Browser window, click on the element.

Ribbon	Design > Element > Editors > Properties
--------	---

	Dialog > Scenarios
Context Menu	<p>Right-click on element Properties Properties > Scenarios</p> <p>On the 'Scenarios' tab of the Responsibility window, right-click on the:</p> <ul style="list-style-type: none"> • Body of the tab and select the 'Add New' option, or • A scenario name and select the 'Modify Selected' option
Keyboard Shortcuts	<p>Alt+5 Properties Dialog > Scenarios</p> <p>Shift+Enter > Scenarios</p> <p>Shift+Alt+S</p>
Other	Double-click on the element > Scenarios

Create a Scenario

If the element does not yet have a Basic Path defined, the 'Type' field defaults to 'Basic Path'.

If the element already has a Basic Path (and/or other paths), click on the New button; the 'Type' field defaults to 'Alternate'. If appropriate you can click on the drop-down arrow and select 'Exception' (or, if necessary, 'Basic Path').

Click on the 'Scenario' field and type in an appropriate

scenario name or title.

Click on the large field under the Toolbar and type in any notes, comments, description or explanation of the scenario you are creating. You can use the Notes Toolbar and context menu to format the text and perform other text processing; see the *Notes* Help topic.

Click on the Save button; the new scenario is added to the 'Scenarios' panel at the bottom of the dialog.

Edit a Scenario

Click on the name of the scenario in the 'Scenarios' panel; the details are displayed in the fields in the top of the screen.

You can change the type, name, and/or notes as required.

Note that the Basic Path can have a great deal of structural specification work attached to it (via the Scenario View), which will be deleted if the path is changed from Basic to something else. If you attempt to make this change, a warning message is displayed. Always make sure that you understand the implications of changing the type of, or deleting, a Basic Path before continuing with the operation.

When you have edited the scenario, click on the Save button.

Reorganize Scenarios

If you want to change the sequence of the scenario paths for the element, check the list in the 'Scenarios' panel and click

on the first scenario to move. Then click on the 'Up Hand' icon or the 'Down Hand' icon to move the scenario up one position or down one position in the list. Do the same for any other scenarios that are not in the right sequence.

Delete Scenarios

If you no longer want to use a particular scenario, click on the scenario name in the 'Scenarios' panel and click on the Delete button. The scenario is immediately removed from the element. You cannot delete the last remaining scenario if it is the Basic Path.

Add a Specification Structure

If you want to create a scenario specification structure from the scenarios, click on the Structure Editor button to display the Scenarios View. This enables you to:

- Add or delete steps in the scenario, or re-sequence them
- Link the Alternate and Exception paths to specific steps of the Basic path
- Manage the elements that the scenario uses at various steps
- Generate diagrams or Test Cases from the scenario
- Add constraints or context references

Scenarios View

The Scenarios View can be displayed in a number of ways, such as directly through the 'Element' panel of the Design ribbon, or through the 'Scenarios' tab on either the element 'Properties' dialog or the Responsibility window. It offers a wide range of facilities for generating and modifying scenarios, which you can use to quickly and easily define the structure, actions and interactions of the scenarios defined for an element such as a Use Case. These scenarios can be the main (basic) path, alternate paths or exception paths.

When you open the Scenarios View it defaults to the basic path so that if it does not already exist, you can create it. You can create alternate paths and exception paths by adding them to steps of the basic path.

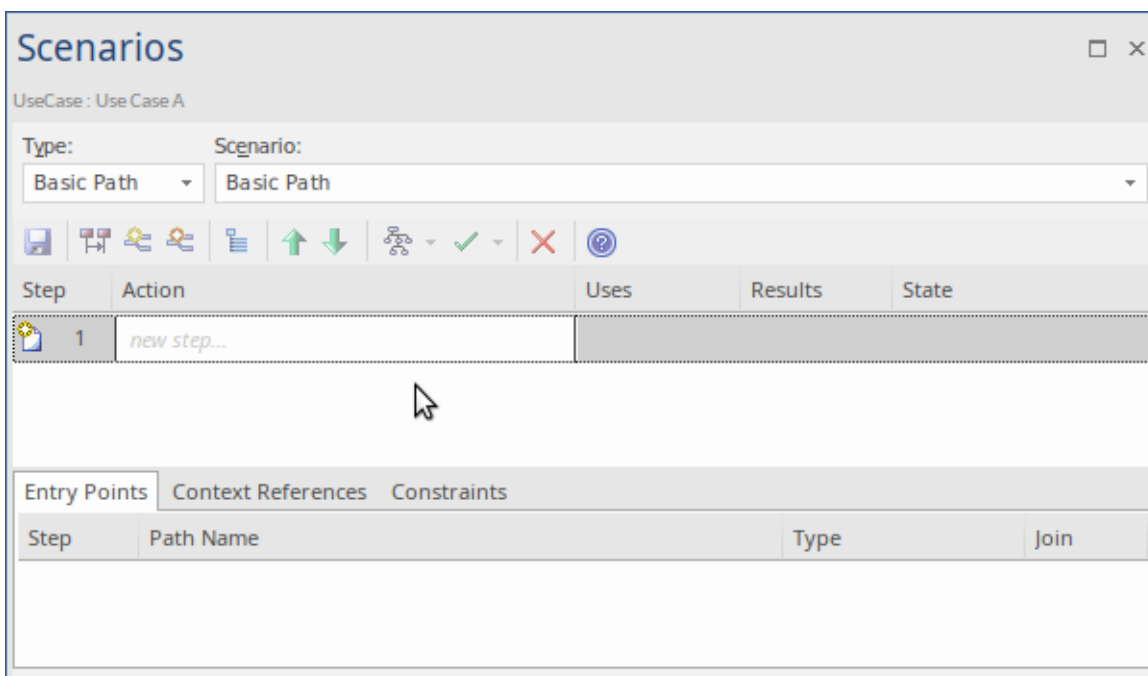

Within the Scenarios View you can:

- Construct the scenario step-by step, or
- Import a text file that describes a scenario, or
- Generate a scenario from an Activity diagram that was itself generated from a scenario (thus regenerating the scenario or importing it from another element)

Access

On a diagram or in the Browser window, click on the element and:

Ribbon	Start > Application > Edit > Responsibilities > Structured Scenarios
Context Menu	Inspector window > Details Right-click on 'Scenarios' New Scenario Inspector window > Details Scenarios right-click on existing scenario Structured Scenario Editor
Keyboard Shortcuts	Alt+2 > Responsibilities > Structured Scenarios
Other	On the 'Scenarios' tab of the Responsibility window, click on the Edit button against a scenario (see the <i>Scenarios Tab - Responsibility Window</i> Help topic) On the 'Scenarios' tab of the element

	'Properties' dialog, click on the Structure Editor button (see the <i>Scenarios Tab - Properties Dialog</i> Help topic)
--	---

Next Step

In the 'Scenario' field, type the name of the basic path of the scenario.

To familiarize yourself with the facilities of the Scenarios View, start with the *Scenarios View Toolbar* Help topic.

If you want to:

- Construct the scenario step-by step, see the *Set Up a Scenario Specification* Help topic
- Complete the scenario based on an imported text file, see the *Import a Scenario File* Help topic
- Generate a scenario from an Activity diagram created from a scenario, see the *Generate Scenario from Activity Diagram* Help topic

Scenarios View Toolbar

In developing a scenario specification, you can perform a wide range of operations using the icons on the Scenarios View toolbar underneath the 'Type' and 'Scenario' fields on the Scenarios View.





Access

On a diagram or in the Browser window, select an element and:

Ribbon	Start > Application > Edit > Responsibilities > Structured Scenarios
Context Menu	Inspector window > Details Right-click on 'Scenarios' New Scenario Inspector window > Details Scenarios right-click on existing scenario Structured Scenario Editor
Keyboard Shortcuts	Alt+2 > Responsibilities > Structured Scenarios
Other	On the 'Scenarios' tab of the Responsibility window, click on the Edit button against a scenario (see the <i>Scenarios Tab - Responsibility Window</i>)

	<p>Help topic)</p> <p>On the 'Scenarios' tab of the element 'Properties' dialog, click on the Structure Editor button (see the <i>Scenarios Tab - Properties Dialog</i> Help topic)</p>
--	---

Toolbar options

Icon	Action
	<p>Click on this icon to save changes to the scenario specification.</p>
	<p>Click on this icon to return to the basic path specification (if another path specification is currently displayed).</p>
	<p>(Enabled when the basic path is displayed - you cannot add an alternate path to another alternate path or to an exception path.)</p> <p>Click on this icon to create a branch from the selected step to an alternate path scenario; select the path from the displayed list. If the appropriate scenario does not yet exist, double-click on the <i>new path</i> line and type the scenario name,</p>

then click off the line and back on to it.
Click on the OK button.



- An entry for this alternate path displays in the 'Entry Points' tab, as step 'a' of the basic path step it branches from; in the 'Join' column, click on the drop-down arrow and select the number of the step at which action flows back to the basic path, or select 'End' if the path terminates separately from the basic path
- You cannot join the end of the alternate branch to more than one step of the basic path; if you change the join point of the branch, any duplicates of that branch are updated to remain in synchrony with the join point





Entry Points			
Step	Path Name	Type	Join
0	In-house Account Processing	Basic Path	-
2a	Access 1	Alternate	6
4a	ATM Path	Alternate	End
6a	Data Not Found	Exception	End



(Only enabled when the basic path is displayed - you cannot add an exception path to another exception path or an alternate path.)

Click on this icon to create a branch from the selected step to an exception path scenario - select the path from the

	<p>displayed list. If the appropriate scenario does not yet exist, double-click on the new path line and type the scenario name, then click off the line and back on to it. Click on the OK button.</p> <ul style="list-style-type: none"> • An entry for this exception path displays in the 'Entry Points' tab, as step 'a' of the basic path step it branches from; in the 'Join' column, click on the drop-down arrow and select the number of the step at which action flows back to the basic path, or select 'End' if the path terminates separately from the basic path • You cannot join the end of the exception branch to more than one step of the basic path; if you change the join point of the branch, any duplicates of that branch are updated to remain in synchrony with the join point
	<p>Click on this icon to display the 'Manage Uses Context List' dialog, which you use to set the 'Uses' column entries to linked context reference lists.</p>
	<p>Click on this icon to move the currently-selected step one place up (including any <i>new step ...</i> line).</p>

	Click on this icon to move the currently-selected step one place down (including any <i>new step ...</i> line).
	Click on this icon to display a list of diagrams that you can generate from the scenario; click on the type of diagram that you want to generate.
	Click on this icon to display a list of Test Suites and Test Cases you can generate, based on this Use Case scenario. Click on the test structure you want to generate.
	Click on this icon to delete the selected step from the scenario.
	Click on this icon to display the Help topic for this tab.

Scenarios View Item Context Menu

You can perform a wide range of operations in creating and managing your scenarios, using the Scenarios View item context menu.

Access

On a diagram or in the Browser window, select an element and use one of these methods to display the Scenarios View. Then right-click on an item in the Step/Action list.

Ribbon	Start > Application > Edit > Responsibilities > Structured Scenarios
Context Menu	Inspector window > Details Right-click on 'Scenarios' New Scenario Inspector window > Details Scenarios right-click on existing scenario Structured Scenario Editor
Keyboard Shortcuts	Alt+2 > Responsibilities > Structured Scenarios
Other	On the 'Scenarios' tab of the Responsibility window, click on the Edit button against a scenario (see the <i>Scenarios Tab - Responsibility Window</i> Help topic)

	<p>On the 'Scenarios' tab of the element 'Properties' dialog, click on the Structure Editor button (see the <i>Scenarios Tab - Properties Dialog</i> Help topic)</p>
--	--

Item menu options

Option	Action
<p>Create Structure From Clipboard Text</p>	<p>Click on this option to display two sub-options to generate a set of steps from a text description or list captured on the clipboard; a new step is generated:</p> <ul style="list-style-type: none"> • After each carriage return in the captured text ('New Line Delimited'), or • For each sentence in the text; that is, after each full stop/space/capital letter combination ('Sentence Delimited') <p>If a set of steps is already displayed, it is overwritten by the generated steps.</p>
<p>Create Structure From Generated Activity</p>	<p>Click on this option to generate a set of steps from an Activity diagram generated from a scenario for a Use Case.</p> <p>If a set of steps is already displayed, it is</p>

Diagram	overwritten by the generated steps.
Add Alternate Path	Click on this option to create a branch from the selected step of the basic path to an alternative path. Shortcut: Ctrl+Shift+N
Add Exception Path	Click on this option to create a branch from the selected step of the basic path to an exception path. Shortcut: Ctrl+Shift+E
Insert Step	Click on this option to display three sub-options, to insert a <i>new step...</i> line: <ul style="list-style-type: none"> • Above the currently-selected step (press Esc to return this new line to the end of the scenario) • Below the currently-selected step (press Esc to return this new line to the end of the scenario) • At the end of the scenario Shortcut: Shift+Insert, Insert or Ctrl+N, respectively
Set Step As 'User' Set Step As 'System'	Click on the appropriate option to switch the entity responsible for performing the action of the selected step between user and system.

<p>Link Step to Use Case</p>	<p>Click on this option to display sub-options to:</p> <ul style="list-style-type: none">• Extend an existing Use Case element• Include the actions of an existing Use Case element, or• Invoke a Use Case as the action of the selected step <p>Selecting the appropriate sub-option displays the 'Select Use Case' dialog, which you use to browse for and select the required Use Case element.</p> <p>The appropriate 'includes', 'extends' or 'invokes' stereotyped connector is created between the current element and the selected Use Case.</p> <p>For the include and extend actions, any text in the 'Action' column is overwritten by the link to the Use Case; for the invoke action, this link is added to the end of the 'Action' text:</p> <p style="text-align: center;">(Invokes: <Use Case Name>)</p>
<p>Merge With Step</p>	<p>Click on this option to merge the selected step with another.</p> <p>A list of the other steps in the scenario displays; click on the step to merge with the selected step.</p>

<p>Move After Step</p>	<p>Click on this option to move the selected step to another position in the scenario. A list of the other steps in the scenario displays; click on the step after which to position the selected step.</p>
<p>Delete</p>	<p>Click on this option to delete the selected step; any subsequent steps are moved up one place. A prompt displays to confirm the deletion. Click on the Yes button.</p>
<p>Highlight Glossary Terms</p>	<p>Select this option to reveal underlines and other markers on text strings that have a glossary definition assigned to them. Select again to clear the 'selected' arrow, to hide the glossary markers in the text. This option is available in the Notes window, 'Notes' and 'Description' fields, Discuss & Review window tabs, Chat & Mail window tabs, Scenario Editor, Specification Manager and 'Mail Message' dialog. This is a global option - selecting it or clearing it for one screen will affect all the other screens.</p>

Scenarios View Selected Text Context Menu

In the Scenarios View, further facilities are available to work with the user-editable text of any part of a specification step. You access these facilities through the item selected-text context menu.

Access

On a diagram or in the Browser window, select an element and use one of these methods to access the Scenarios View. In the Scenarios View, highlight the text string and right-click on it.

Ribbon	Start > Application > Edit > Responsibilities > Structured Scenarios
Context Menu	Inspector window > Details Right-click on 'Scenarios' New Scenario Inspector window > Details Scenarios right-click on existing scenario Structured Scenario Editor
Keyboard Shortcuts	Alt+2 > Responsibilities > Structured Scenarios
Other	On the 'Scenarios' tab of the

	<p>Responsibility window, click on the Edit button against a scenario (see the <i>Scenarios Tab - Responsibility Window</i> Help topic)</p> <p>On the 'Scenarios' tab of the element 'Properties' dialog, click on the Structure Editor button (see the <i>Scenarios Tab - Properties Dialog</i> Help topic)</p>
--	--

Text menu options

Option	Action
Create	<p>Click on this option to display two sub-options that you can select to use the highlighted text as the base for either:</p> <ul style="list-style-type: none"> • A glossary definition or • A new element
Link Step to Use Case	<p>Click on this option to display sub-options to define the actions of the selected step by:</p> <ul style="list-style-type: none"> • Including the actions of an existing Use Case element • Extending an existing Use Case element, or

	<ul style="list-style-type: none"> • Invoking a Use Case <p>Selecting the appropriate sub-option displays the 'Select Use Case' dialog, which you use to browse for and select the required Use Case element.</p> <p>The appropriate includes, extends or invokes stereotyped connector is created between the current element and the selected Use Case.</p> <p>For the include and extend actions, any text in the 'Action' field is overwritten by the link to the Use Case; for the invoke action, this link is added to the end of the 'Action' text:</p> <p style="padding-left: 40px;">(Invokes: <Use Case Name>)</p>
<p>Link to existing Element</p>	<p>('Uses' and 'Results' field text only.) Click on this option to create a Realization or Dependency relationship to a Requirement, Feature, Activity, BPMN Task, DMN Decision or other element elsewhere in the model.</p> <p>You select the element and connector types from submenu options that then display the 'Select Element' dialog, which you use to browse for and select the required element.</p>
<p>Insert context</p>	<p>Click on this option to add a reference to</p>

reference	<p>an element stored elsewhere in the model, and create an entry for the element in the 'Context References' tab.</p> <p>Selecting this option displays the 'Select Element' dialog, which you use to browse for and select the required reference element.</p>
Insert glossary definition	<p>Click on this option to insert an existing glossary term at the cursor position. To select the term, double-click on it in the displayed list.</p> <p>When you select the term it is inserted into the field as highlighted and underlined text, which displays the definition when you move the cursor over it. If you highlighted part of the original text, the term overwrites that text.</p>
Manage Uses Context List	<p>(On highlighted text or a specific cursor position in the 'Uses' column.)</p> <p>Click on this option to display the 'Manage Uses Context List' dialog, which you can use to:</p> <ul style="list-style-type: none">• Browse to or type in a context reference item• Re-sort the list with up and down arrow keys

	<ul style="list-style-type: none"> • Remove an entry from the list • Enable or disable the 'Uses Context List' facility across the model <p>You can resize the dialog to show the full details of context reference items.</p> <p>If you enable the 'Uses Context List' facility, you do not necessarily have to use the dialog to add context list items; you can type or insert an element name from the 'Context References' tab in the 'Uses' column, and that name is added to the 'Uses Context List'.</p> <p>If you disable the 'Uses Context List' facility, the context list items in the 'Uses' column are hidden.</p>
Split Step	<p>Click on this option to split the selected step into two consecutive steps.</p> <p>The option is available only if you highlight a portion of the text in the selected field. The new step takes the highlighted text as its 'Action' text.</p>
Search for <text>	<p>Click on this option to display the Code Editor menu of options for locating the selected text in a number of locations.</p>
Undo	<p>Click on this option to undo any unsaved</p>

	changes you have just made in the step.
Cut	Select this option to cut the selected text to the clipboard.
Copy	Select this option to copy the selected text to the clipboard.
Paste	Select this option to paste the current contents of the clipboard.
Delete	Select this option to delete the selected text string.
Select All	Select this option to select all text in the current field.

Scenarios View Entry Points Context Menu

In the lower section of the Scenarios view, the 'Entry Points' tab shows how the basic path, alternate path and exception path scenarios for the element are organized and interrelated. If an alternate path or exception path has been defined but has not yet been added to the basic path, it is not listed on this tab. You can perform certain operations on the items of the 'Entry Points' tab, using the context menu.

Access

On a diagram or in the Browser window, select an element use one of the options here to display the Scenarios View. Then click on the appropriate entry in the 'Entry Points' tab.

Ribbon	Start > Application > Edit > Responsibilities > Structured Scenarios
Context Menu	Inspector window > Details Right-click on 'Scenarios' New Scenario Inspector window > Details Scenarios right-click on existing scenario Structured Scenario Editor
Keyboard Shortcuts	Alt+2 > Responsibilities > Structured Scenarios

Other	<p>On the 'Scenarios' tab of the Responsibility window, click on the Edit button against a scenario (see the <i>Scenarios Tab - Responsibility Window</i> Help topic)</p> <p>On the 'Scenarios' tab of the element 'Properties' dialog, click on the Structure Editor button (see the <i>Scenarios Tab - Properties Dialog</i> Help topic)</p>
-------	--

Entry Points menu options

Option	Action
Edit Path	Click on this option to display the steps of the scenario in the Scenarios view, with the first step highlighted.
Join with Step	<p>(Available only if the basic path scenario is displayed in the Scenarios view, to join the selected alternate or exception path with the basic path. Not available to change the basic path scenario itself.)</p> <p>Click on this option to highlight the 'Join' field and its drop-down arrow. Click on the drop-down to define or change the</p>

	<p>step number at which the alternate or exception path rejoins the basic path. Select 'End' if the path does not rejoin the basic path steps.</p>
Remove Entry Point	<p>(Available only if the basic path scenario is displayed in the Scenarios view, to delete a junction with the basic path. Not available to delete any part of the basic path scenario itself.)</p> <p>Click on this option to delete the relationship between the selected path and the basic path, and remove the entry from the 'Entry Points' tab.</p> <p>A prompt displays to confirm the deletion. Click on the Yes button to delete the junction.</p>

Notes

- You can switch focus between the 'Entry Points' tab and the sequence of steps by pressing Alt+Q

Scenarios View Floating Toolbar

Wherever a reference to another element exists in the 'Uses' column of the Scenarios view (that is, where the text is highlighted and underlined), if you move the cursor over the element name a short floating toolbar displays. You can select the icons on this toolbar to:

- Display the element's 'Properties' dialog
- Locate the element in its parent diagram
- Locate the element in the Browser window

Import a Scenario File

Scenarios are often created as text descriptions in document files. These might be simple paragraph descriptions or more complex constructions with numbered and bulleted lists. As a valuable time-saving facility, you can use the text of these files as the source for new structured scenarios for elements within the model. You might write a draft description in a text file and then import it into the model as a template for the structured scenario.

To create a scenario in this way, firstly access the Scenarios View as described in the *Scenarios View* Help topic (for instance, Start > Application > Design > Simple Scenarios). Then:

1. In the 'Scenario' field, type a name for the new scenario.
2. Switch to the text or document file, and select and copy the required text. (The text is stored on the clipboard.)
3. Switch back to the Scenarios View, right-click in the center panel (below the first row of fields) and select the 'Create Structure From Clipboard Text' option. This displays two sub-options:
 - 'New Line Delimited', which creates a new step after each carriage return in the captured text
 - 'Sentence Delimited', which creates a new step after each sentence in the text; that is, after each full stop/space combination
4. Select the appropriate option for your requirements. The Scenarios View organizes the copied text into a series of

numbered steps, alternating between non-system actor and system actor roles.

5. Edit and add to the scenario as suggested by the *Set Up Scenario Specification* Help topic, and using the facilities described in the *Scenarios View* subtopics.

Notes

- If the Scenarios View already contains scenario steps when you import text from a file, those steps are overwritten, not merged or appended
- By default, the steps begin with a user step (indicated by an 'Actor' icon) and alternate between user and system (indicated by a 'Screen' icon) steps; however, the responsible entity assigned to a new step might be different if the new line or sentence contains a keyword - 'User' or 'Actor' for a user step, or 'System' for a system step - within the first 15 characters of text
- Once a step has been saved, you can change the responsible entity by either double-clicking on the icon or right-clicking on the step, and selecting 'Set Step as 'System'' or 'Set Step as 'User'' as required

Set Up Scenario Specification

You can create a specification for a scenario in one of a number of ways:

- Build the specification yourself, as described here, perhaps starting from a scenario created on the 'Scenarios' tab of either the Responsibility window or the 'Properties' dialog for the element
- Generate a specification from an Activity diagram generated itself from a scenario - see the *Generate Scenario From Activity Diagram* Help topic
- Generate a specification from text held on the clipboard - see the *Import a Scenario File* Help topic

Access

On a diagram or in the Browser window, select an element and open the Scenario View using one of these methods:

Ribbon	Start > Application > Edit > Responsibilities > Structured Scenarios
Context Menu	Inspector window > Details Scenarios (right click) New Scenario > Scenario View Inspector window > Details Scenarios right-click on existing Scenario Structured Scenario Editor

Keyboard Shortcuts	Alt+2 > Responsibilities > Structured Scenarios
Other	<p>On the 'Scenarios' tab of the Responsibility window, click on the Edit button against a scenario (see the <i>Scenarios Tab - Responsibility Window</i> Help topic)</p> <p>On the 'Scenarios' tab of the element 'Properties' dialog, click on the Structure Editor button (see the <i>Scenarios Tab - Properties Dialog</i> Help topic)</p>

Enter the specification basic path

Step	Action
1	<p>In the 'Type' field, click on the drop-down arrow and select 'Basic Path' (the system will generally default to this value).</p> <p>In the 'Scenario' field type the name of the scenario basic path.</p> <p>(These fields will be completed already if you have selected to work on a scenario created on the 'Scenarios' tab of the Responsibility window or</p>

	'Properties' dialog.)
2	In the 'Action' column, overwrite the <i>new step</i> text with the name of the first step or action.
3	<p>Tab to the 'Uses' column and, if appropriate, type the name of each element used in this step. If the elements are highlighted in blue and underlined, it indicates that they are already listed in the 'Context References' tab.</p> <p>You can also manage the list of elements as context references, and add to the list directly; see the <i>Notes</i>.</p>
4	Tab to the 'Results' column and, if appropriate, type the outcome of completing this step.
5	Tab to the 'State' column and, if appropriate, type the name of the state into which the step moves the action.
6	<p>When you move out of the 'Action' column, the next new step field displays underneath.</p> <p>Repeat steps 2 to 5 as many times as is necessary.</p> <p>The Scenarios view should now resemble this:</p>

Scenarios

UseCase : Withdraw Money from Account

Type: Basic Path Scenario: In-house Account Processing

Step Action Uses Results State

1	Customer inserts ATM_card into ATM	ATM		START
2	ATM displays prompt for PIN			PROMPT_FOR_PIN
3	Customer enters PIN into ATM	Customer		PIN_ENTERED
4	ATM verifies PIN			
5	ATM displays service options			
6	Customer selects option on ATM			
7	ATM performs selected transaction			
8	ATM ejects ATM_card from slot			
	new step...			

Entry Points Context References Constraints

Step	Path Name	Type	Join
0	In-house Account Processing	Basic Path	-
5a	Advise PIN Error	Alternate	3

7 Click on the  icon in the Scenarios View toolbar.

Notes

- By default, the steps begin with a user step (indicated by

an 'Actor' icon) and alternate between user and system (indicated by a 'Screen' icon) steps; however, you can control the responsible entity assigned to a new step by typing a keyword within the first 15 characters of the text in the 'Action' column - either 'User' or 'Actor' for a user step, or 'System' for a system step

Once a step has been saved, you can change the responsible entity by either double-clicking on the icon or right-clicking on the step, and selecting 'Set Step as 'System"' or 'Set Step as 'User"' as required

- An entry for the basic path displays in the 'Entry Points' tab, as Step 0 with no value in the 'Join' column (the basic path does not rejoin itself)
- The values in the 'Uses', 'Results' and 'State' columns, whilst optional, are significant if you want to generate a diagram from the specification; if you type the name of an element linked to the current element (and listed in the 'Context References' tab), the element name is highlighted and underlined
- In the 'Uses' column, in edit mode, use the 'Manage Uses Context List' context menu option to enable and disable 'Uses' cells as linked element lists as well as text fields, across the whole model; when the feature is enabled, the column shows both context-linked elements and manually-entered text, and when disabled only text entries are listed (the context-linked entries are hidden and deactivated, but not deleted - they are re-activated when the feature is enabled)
- As you develop the scenario, you can move steps to

different positions in the scenario, and insert new step lines within the body of the scenario

- You can also create constraints on the element that have an impact on the scenarios
- Repeat this *Set Up Scenario Specification* procedure for each scenario you have created; you can now adapt, enhance and interrelate the scenario specifications using the facilities of the Scenarios View:
 - Scenarios View Toolbar
 - Item context menu
 - Selected Text context menu
 - Entry Points context menu
 - Floating Toolbar

Generate Diagrams

When you have created a structured scenario, you can generate diagrams of any of these types from it:

- Activity
 - Basic
 - With ActivityParameter
 - With Action
 - With Action Pin
- Rule Flow
- State
- Sequence
- Robustness

Access

On a diagram or in the Browser window, click on the element and:

Ribbon	Start > Application > Edit > Responsibilities > Structured Scenarios
Context Menu	Inspector window > Details Right-click on 'Scenarios' New Scenario Inspector window > Details Scenarios right-click on existing scenario Structured Scenario Editor

Keyboard Shortcuts	Alt+2 > Responsibilities > Structured Scenarios
Other	<p>On the 'Scenarios' tab of the Responsibility window, click on the Edit button against a scenario (see the <i>Scenarios Tab - Responsibility Window</i> Help topic)</p> <p>On the 'Scenarios' tab of the element 'Properties' dialog, click on the Structure Editor button (see the <i>Scenarios Tab - Properties Dialog</i> Help topic)</p>

Generate the required diagram

Step	Action
1	Create the scenario structure in the Scenarios view.
2	Click on the  ('Generate Diagram') icon in the toolbar on the tab.
3	Click on the type of diagram to generate. Enterprise Architect generates the diagram and notifies you that generation is complete. Click on the OK button and then close the 'Properties' dialog to

review the diagram.

If the diagram being generated already exists under the selected element, a prompt displays to overwrite or synchronize with that diagram.

Select the appropriate radio button to:

- Overwrite the existing diagram (delete the existing diagram and elements, and create a new diagram and elements) or
- Synchronize the elements in the existing diagram with the scenario steps (however, Sequence and Robustness diagrams cannot be synchronized)

Notes

- The 'Synchronize elements in existing diagram' option enables the 'Preserve Diagram Layout' checkbox, which you can select to preserve the existing arrangement of elements and connectors on the diagram; any new elements are added to the diagram in the default position, and you manually position them in the diagram as required; if you do not select the checkbox, the diagram is recast in the default layout
It is recommended that you uncheck the 'Preserve Diagram Layout' checkbox if you are synchronizing elements with scenario steps:
 - When new steps have been added or existing steps have been deleted or moved within the Use

Case

- For the first time in a Use Case that has been imported from XMI with the 'Strip GUIDs' option selected
- For the first time in a Use Case that has been copied and pasted in the Browser window, or
- For the first time in a Use Case whose containing Package has been copied and pasted in the Browser window

Generate Activity Diagram

When you create a scenario on an element, and then generate an Activity diagram from the scenario, an Activity is generated as a child of the selected element to act as a container for the diagram.

- Each scenario step is modeled as a CallBehaviorAction that will have an Activity behavior
- The values of the 'Uses', 'Results' and 'State' columns for each step are added as memo Tagged Values of the corresponding Activity

Access

On a diagram or in the Browser window, click on the element and select one of these access methods to display the Scenarios view, then click on  and select 'Activity'.

Ribbon	Start > Application > Design > Structured Scenarios
Context Menu	Inspector window > Details Right-click on 'Scenarios' New Scenario Inspector window > Details Scenarios right-click on existing scenario Structured Scenario Editor
Keyboard	Alt+2 > Responsibilities > Structured

Shortcuts	Scenarios
Other	<p>On the 'Scenarios' tab of the Responsibility window, click on the Edit button against a scenario (see the <i>Scenarios Tab - Responsibility Window</i> Help topic)</p> <p>On the 'Scenarios' tab of the element 'Properties' dialog, click on the Structure Editor button (see the <i>Scenarios Tab - Properties Dialog</i> Help topic)</p>

Example

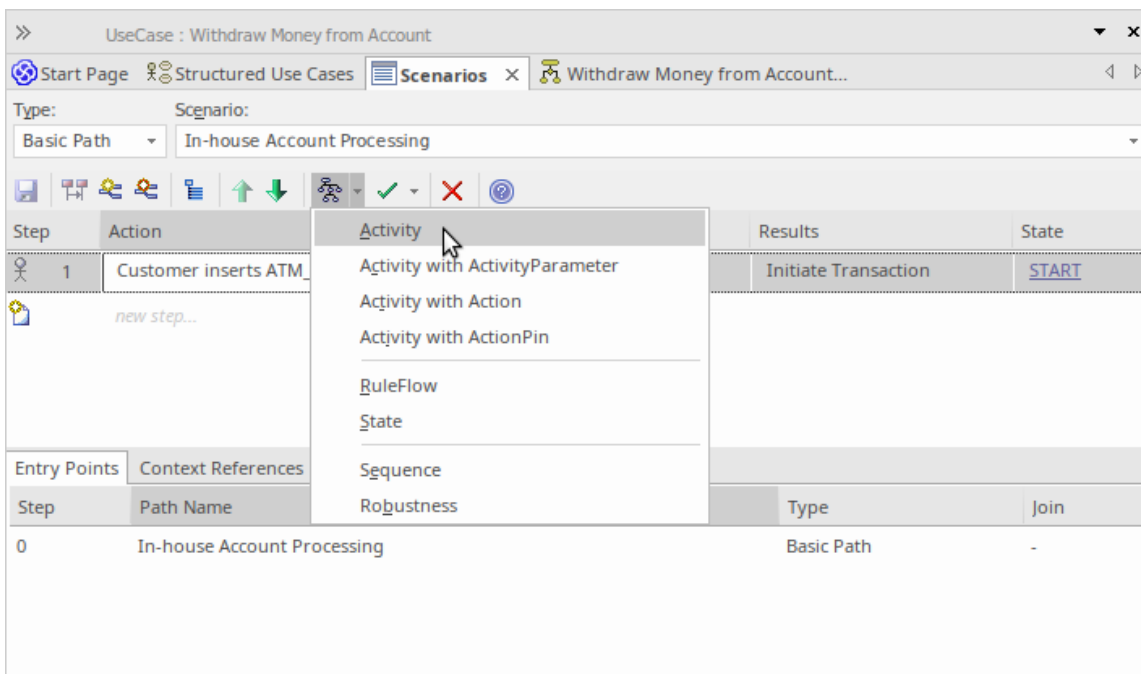

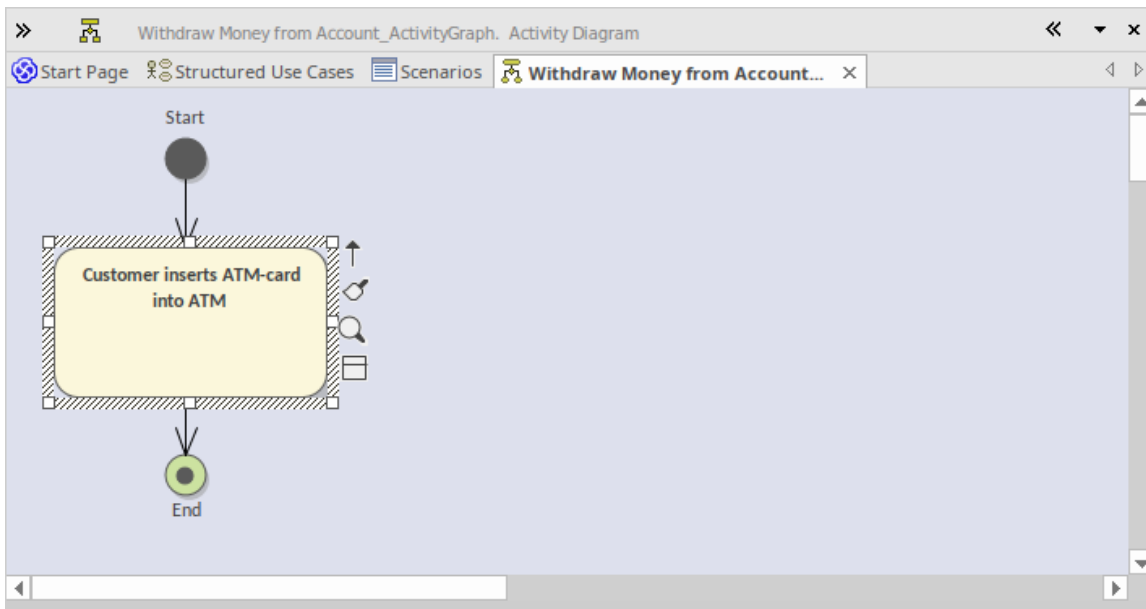

Browser

Project Context Diagram Element

- Login
- Withdraw Money from Account
 - Withdraw Money from Account_ActivityGraph
 - Withdraw Money from Account_ActivityGraph
 - Customer inserts ATM-card into ATM**
 - End
 - Start
- :Customer

Properties

Element Behavior Parameters Partitions Tags

Activity (Customer inserts ATM-card into ATM)

result	<memo>*
state	<memo>*
step_guid	{2EAC5710-EB87-407f-BEA0-19D5F8B68A48}
trigger	User
uses	<memo>*

Diagram Types

There are three additional variations of the Activity diagram that you can generate.

Diagram	Detail
Activity with ActivityParameter	<ul style="list-style-type: none"> • The values of the 'Uses' and 'Results' columns are modeled as ActionPins bound to ActivityParameters • The ActionPins and ActivityParameters are added to the Browser window and not to the diagram • The value of the 'State' column is added as a Tagged Value of each Action only • The parent of the Activity will be the context element, not the container element
Activity with Action	<ul style="list-style-type: none"> • The scenario steps are modeled as Actions • The values of the 'Uses', 'Results' and 'State' columns are added as Tagged Values of each Action
Activity with ActionPin	<ul style="list-style-type: none"> • The scenario steps are modeled as Actions • The values of the 'Uses' and 'Results' columns are modeled as Input Pins and

	<p>Output Pins respectively</p> <ul style="list-style-type: none">• ActionPins are added to the Browser window and not to the diagram• The value of the 'State' column is added as a Tagged Value of each Action
--	---

Generate RuleFlow Diagram

When you create a scenario on an element and then generate a RuleFlow diagram, a Rule Flow Activity is created as a child of the selected element, to act as a container for the diagram.

- The scenario steps are modeled as RuleTasks
- The values of the 'Uses', 'Results' and 'State' columns are added as Tagged Values of the RuleTasks

Access

On a diagram or in the Browser window, select an element and use one of these access paths to display the Scenarios view, then click on  and select 'RuleFlow'.

Ribbon	Start > Application > Design > Structured Scenarios
Context Menu	Inspector window > Details Right-click on 'Scenarios' New Scenario Inspector window > Details Scenarios right-click on existing scenario Structured Scenario Editor
Keyboard Shortcuts	Alt+2 > Responsibilities > Structured Scenarios

Other	<p>On the 'Scenarios' tab of the Responsibility window, click on the Edit button against a scenario (see the <i>Scenarios Tab - Responsibility Window</i> Help topic)</p> <p>On the 'Scenarios' tab of the element 'Properties' dialog, click on the Structure Editor button (see the <i>Scenarios Tab - Properties Dialog</i> Help topic)</p>
-------	--

Generate StateMachine Diagram

When you create a scenario on an element and then generate a StateMachine diagram, a StateMachine is created as a child of the selected element to act as a container for the diagram.

- Each value in the 'State' column is modeled as a State
- The scenario steps become the Transition connectors between the States
- The values of the 'Uses' and 'Results' columns are added as Tagged Values of the Transition connectors

Access

On a diagram or in the Browser window, click on the element and select one of these access methods to display the Scenarios view, then click on  and select 'State'.

Ribbon	Start > Application > Design > Structured Scenarios
Context Menu	Inspector window > Details Right-click on 'Scenarios' New Scenario Inspector window > Details Scenarios right-click on existing scenario Structured Scenario Editor
Keyboard	Alt+2 > Responsibilities > Structured

Shortcuts	Scenarios
Other	<p>On the 'Scenarios' tab of the Responsibility window, click on the Edit button against a scenario (see the <i>Scenarios Tab - Responsibility Window</i> Help topic)</p> <p>On the 'Scenarios' tab of the element 'Properties' dialog, click on the Structure Editor button (see the <i>Scenarios Tab - Properties Dialog</i> Help topic)</p>

Example

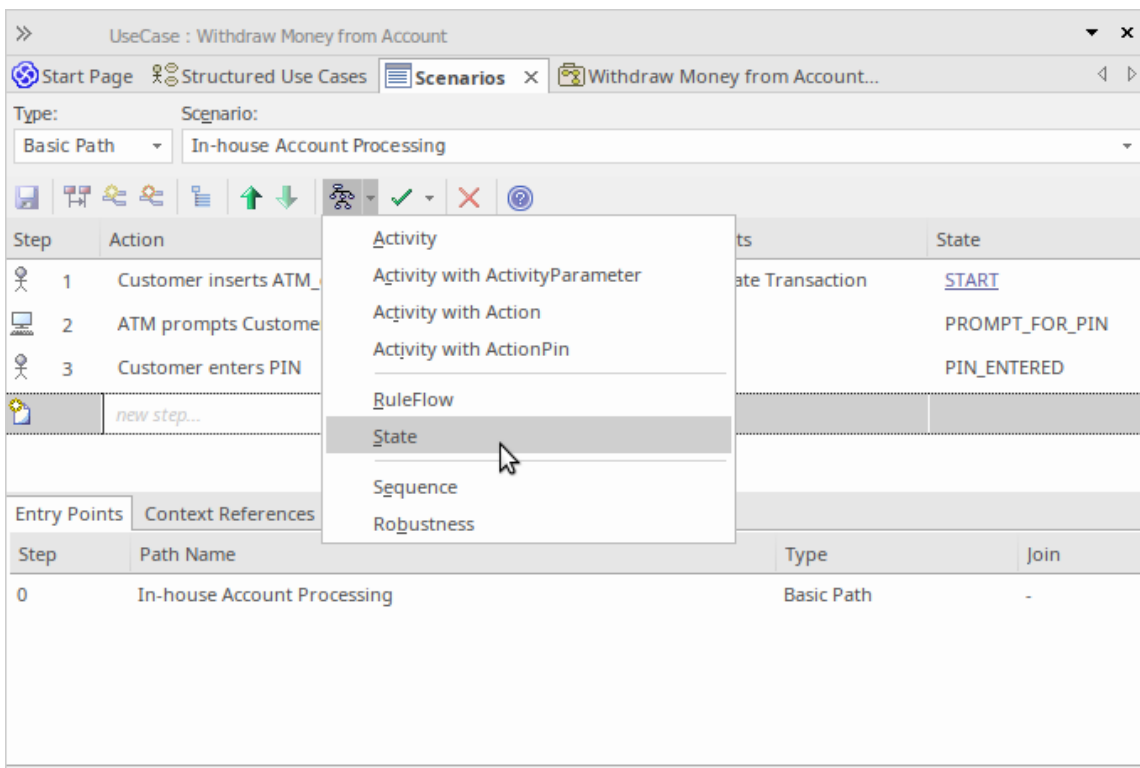

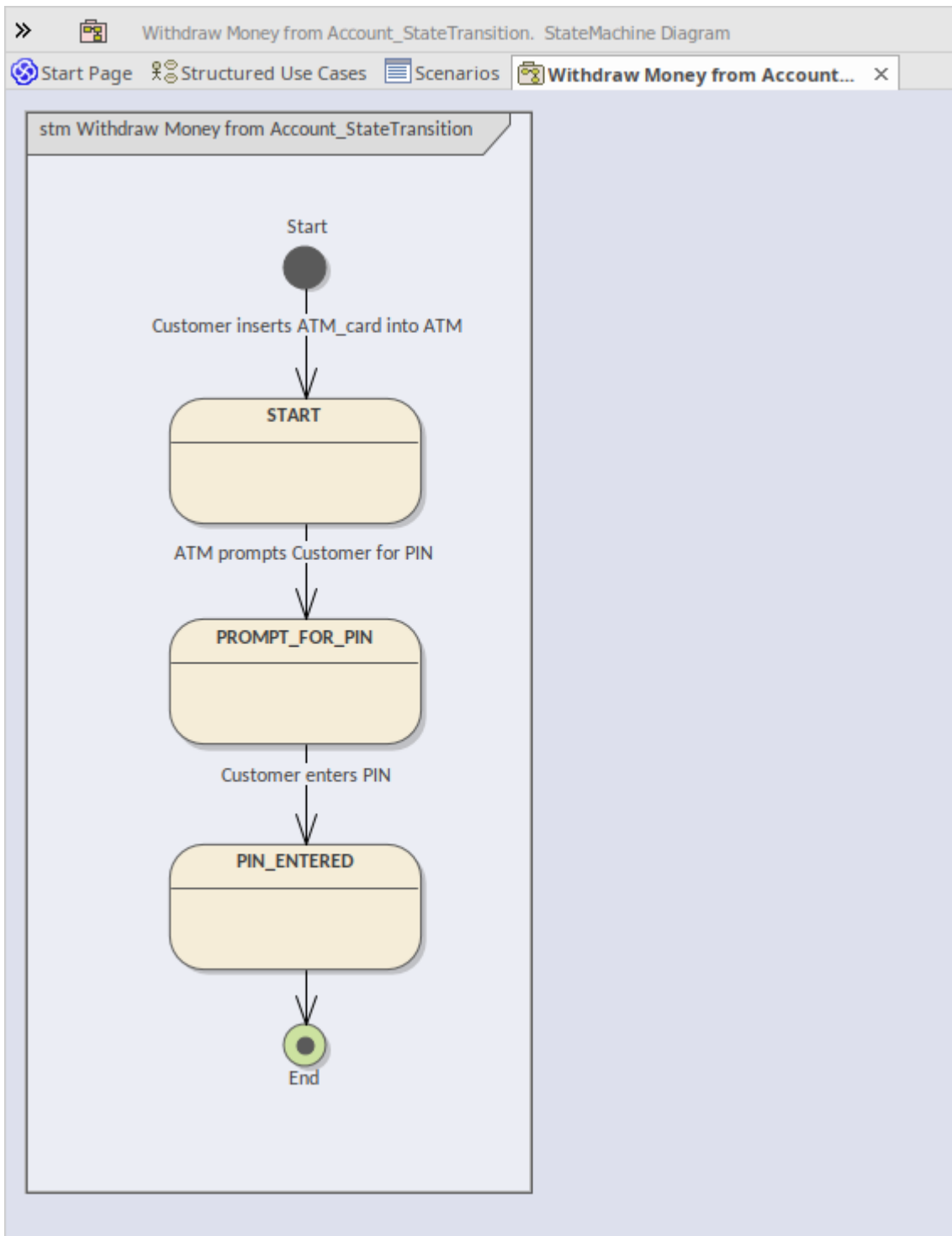

Generate Sequence Diagram

When you create a scenario on an element and then generate a Sequence diagram, an Interaction is created as a child of the selected element to act as a container for the diagrams - the Basic, Alternate and Exception paths are each modeled as a separate Sequence diagram under the Interaction. There are a number of points to note in this process:

- All the elements involved in the scenario must be identified in the 'Context Reference' tab; that is, relationships must already exist between the scenario parent element and the other elements named in the scenario (the Scenario is a Process, and the Sequence diagram is showing the flow of messaging between different Lifelines; for that to happen the lifeline/object has to be defined, which is achieved using a Context Reference)
- So, each Context Reference element named in a scenario step is modeled as a Lifeline
- The step itself becomes the Message between an originator and its destination(s)
- The first Context Reference element in a step is treated as the originator
- The subsequent Context Reference element(s) become the destination(s)
- Because the diagram generator acts on element names in the step, you must not use the element names as normal text; for example, in step 1 in the example dialog, the term

ATM-Card is interpreted as a reference to the ATM element, and two 'Customer inserts ATM-Card into ATM' messages are generated for the step (to avoid confusion, in the diagram the first Message has been deleted)

- If you have not selected the 'Show Sequence Numbering' checkbox on the 'Diagram Sequence' page of the 'Preferences' dialog, the Message name on the Sequence diagram is prefixed by the step number, as shown in the example diagram in this topic; if you have selected the checkbox, the message sequence number is shown instead of the step number
- The values of the 'Uses', 'Results' and 'State' columns are added as Tagged Values of the Message

Access

On a diagram or in the Browser window, click on the element and select one of these access methods to display the Scenarios View, then click on  and select 'Sequence'.

Ribbon	Start > Application > Edit > Responsibilities > Structured Scenarios
Context Menu	Inspector window > Details Right-click on 'Scenarios' New Scenario Inspector window > Details Scenarios right-click on existing scenario Structured Scenario Editor

Keyboard Shortcuts	Alt+2 > Responsibilities > Structured Scenarios
Other	<p>On the 'Scenarios' tab of the Responsibility window, click on the Edit button against a scenario (see the <i>Scenarios Tab - Responsibility Window</i> Help topic)</p> <p>On the 'Scenarios' tab of the element 'Properties' dialog, click on the Structure Editor button (see the <i>Scenarios Tab - Properties Dialog</i> Help topic)</p>

Example

The screenshot shows a software modeling tool interface for a Use Case diagram. The title bar indicates the Use Case is 'Withdraw Money from Account'. The main workspace displays a scenario named 'In-house Account Processing' with a 'Basic Path' type. The scenario consists of eight steps:

1. Customer inserts ATM card
2. ATM displays prompt for PIN
3. Customer enters PIN in keypad
4. ATM verifies PIN
5. ATM displays service options
6. Customer selects option
7. ATM performs selected transaction
8. ATM ejects ATM card from slot

A context menu is open over the first step, offering the following options: Activity, Activity with ActivityParameter, Activity with Action, Activity with ActionPin, RuleFlow, State, Sequence (highlighted), and Robustness.

Below the scenario, there are three tabs: 'Entry Points', 'Context References', and 'Constraints'. The 'Entry Points' tab is active, showing a table with the following data:

Name	Type	Connection	Comment	Package
Customer	Actor	Usage		Actors
ATM	Class	Usage		Classes

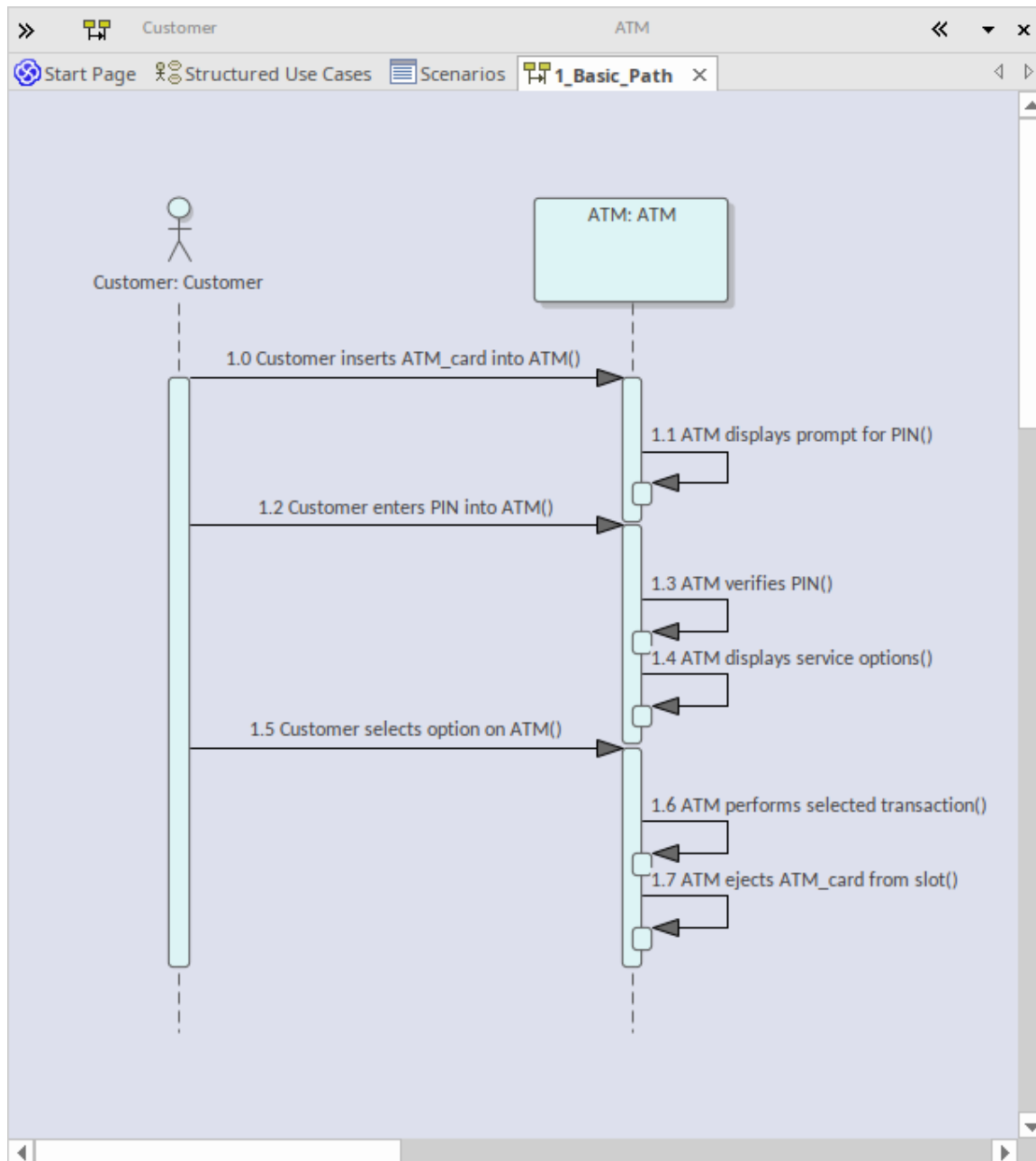

Generate Robustness Diagram

When you create a scenario on an element and then generate a Robustness diagram, a Collaboration is created as a child of the selected element to act as a container for the Robustness diagram.

Access

On a diagram or in the Browser window, click on the element and select one of these access methods to display the Scenarios view, then click on  and select 'Robustness'.

Ribbon	Start > Application > Edit > Responsibilities > Structured Scenarios
Context Menu	Inspector window > Details Right-click on 'Scenarios' New Scenario Inspector window > Details Scenarios right-click on existing scenario Structured Scenario Editor
Keyboard Shortcuts	Alt+2 > Responsibilities > Structured Scenarios
Other	On the 'Scenarios' tab of the Responsibility window, click on the Edit button against a scenario (see the

Scenarios Tab - Responsibility Window Help topic)
 On the 'Scenarios' tab of the element 'Properties' dialog, click on the Structure Editor button (see the *Scenarios Tab - Properties Dialog Help topic)*

Example

Step	Action
1	System displays the <u>Login Page</u> to the <u>User</u>
2	<u>User</u> enters username and password
3	System validates the <u>User</u> details against the <u>Account</u>

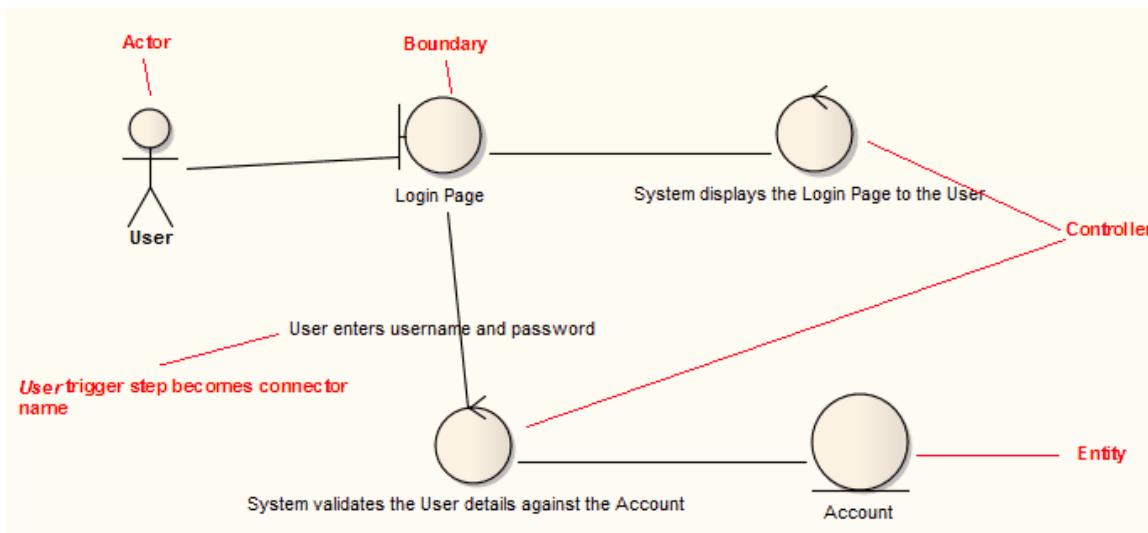

Notes

- All the elements involved in the scenario should be identified in the 'Context Reference' tab; that is, relationships must already exist between the scenario parent element and the other elements named in the

scenario

- Any values in the 'Uses', 'Results' and 'State' columns are ignored and not represented in the diagram
- Each UI element in a step becomes a Boundary element; a Dependency relationship is created from this Boundary element to the UI element (this connector is not shown on the diagram)
- Each Actor referenced in a step is dropped into the Robustness diagram as a simple link
- Each Class referenced in a step is dropped into the Robustness diagram as a simple link, and is given the stereotype entity
- Each step with a System trigger becomes a Controller; alternate/exception path Controllers are displayed with a red background color
- Each step with a User trigger becomes the name of the Association between Controllers

Generate Scenario From Activity Diagram

You can generate a range of diagrams from a scenario in an element. Conversely, you can also generate a structured scenario within an element from an Activity diagram that was previously generated from a scenario, effectively either regenerating the scenario within the Use Case, or transferring a scenario into another Use Case.

Access

On a diagram or in the Browser window, click on the element and select one of these access methods to display the Scenarios View, then right-click on a space and select the 'Create Structure From Generated Activity Diagram' option.

Ribbon	Start > Application > Edit > Responsibilities > Structured Scenarios
Context Menu	Inspector window > Details Right-click on 'Scenarios' New Scenario Inspector window > Details Scenarios right-click on existing scenario Structured Scenario Editor
Keyboard	Alt+2 > Responsibilities > Structured

Shortcuts	Scenarios
Other	<p>On the 'Scenarios' tab of the Responsibility window, click on the Edit button against a scenario (see the <i>Scenarios Tab - Responsibility Window</i> Help topic)</p> <p>On the 'Scenarios' tab of the element 'Properties' dialog, click on the Structure Editor button (see the <i>Scenarios Tab - Properties Dialog</i> Help topic)</p>

Generate a scenario from an Activity diagram

Step	Action
1	On the 'Select an Activity (generated from a UseCase Scenario) containing the Diagram' dialog, search for and select the Activity containing the required diagram.
2	Click on the OK button. A prompt displays to remind you that any existing scenario steps will be deleted.

- | | |
|---|---|
| 3 | <p>Click on the Yes button.</p> <p>The system validates the diagram (displaying the results in the 'Scenario Generation' tab of the System Output window) and, if the diagram is valid, generates the scenario steps in the Scenarios view.</p> |
|---|---|

Notes

- The source Activity diagram must be generated from another Use Case scenario
- This facility operates on the simple Activity diagrams generated from a Use Case, but not on enhanced Activity diagrams - those generated with ActivityParameters, Actions and Action Pins

Generate Test Cases

When you have defined a scenario, you can generate one of a number of Test Cases from it, including:

- A Test Suite - Horizontal Layout
- A Test Suite - Vertical Layout
- An Internal Test Case or
- An External Test Case

Access

On a diagram or in the Browser window, click on the element and select one of these access methods to display the Scenarios view, then click on  and select the TestCase type.

Ribbon	Start > Application > Edit > Responsibilities > Structured Scenarios
Context Menu	Inspector window > Details Right-click on 'Scenarios' New Scenario Inspector window > Details Scenarios right-click on existing scenario Structured Scenario Editor
Keyboard Shortcuts	Alt+2 > Responsibilities > Structured Scenarios

<p>Other</p>	<p>On the 'Scenarios' tab of the Responsibility window, click on the Edit button against a scenario (see the <i>Scenarios Tab - Responsibility Window</i> Help topic)</p> <p>On the 'Scenarios' tab of the element 'Properties' dialog, click on the Structure Editor button (see the <i>Scenarios Tab - Properties Dialog</i> Help topic)</p>
--------------	--

Test Cases Generated

Test Case	Detail
<p>Test Suite - Horizontal Layout</p>	<p>A Test Case element is created, which acts as a container for the created Test Suite diagram and Test Case elements. The basic path and each alternate and exception path is represented by a Test Case element. Each step in the basic, alternate and exception paths is represented by a Test element.</p> <p>A diagram is created under the container Test Case element, to which the Test Case and Test elements are added.</p> <p>The elements are displayed on the diagram in a matrix format, with the basic</p>

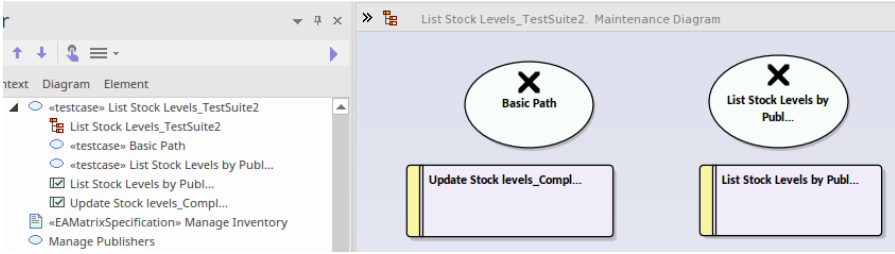
	<p>path and its steps forming the first column followed by the alternate and exception paths as subsequent columns.</p>  <p>Note that the name of each created Test Case and Test element is truncated to 25 characters.</p>
<p>Test Suite - Vertical Layout</p>	<p>A Test Case element is created, which acts as a container for the created diagram and Test Suite elements.</p> <p>The basic path and each alternate and exception path is represented using a Test Case element. Each step in the basic, alternate and exception paths is represented by a Test element.</p> <p>A diagram is created under the container Test Case element, to which the Test Case and Test elements are added.</p> <p>The elements are displayed on the diagram in a single column with the basic path and its steps at the top followed by each alternate and/or exception path and its steps.</p>

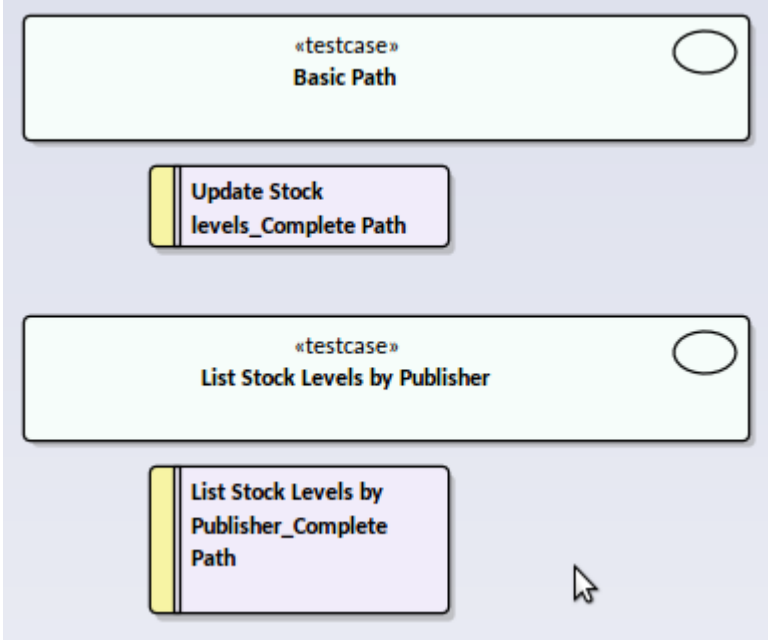
	
<p>Internal Test Case</p>	<p>A test is generated for the basic path and each alternate and exception path in the scenario, and added to the selected element.</p> <p>In addition, for each step in the basic, alternate and exception paths that has a value in the 'Results' column, a test is generated and added to the selected element.</p> <p>A diagram is created under the selected element, to which that element and a Note (showing the element's scenario specification) is added.</p> <p>The created tests are displayed in the Test Scripts compartment of the selected element on the diagram. Another way to view these tests is to click on the element</p>

and display the Test Cases window. These generated tests are written to the Scenario Class Type of the Test Cases window; you can change the tests to another test-type if required.

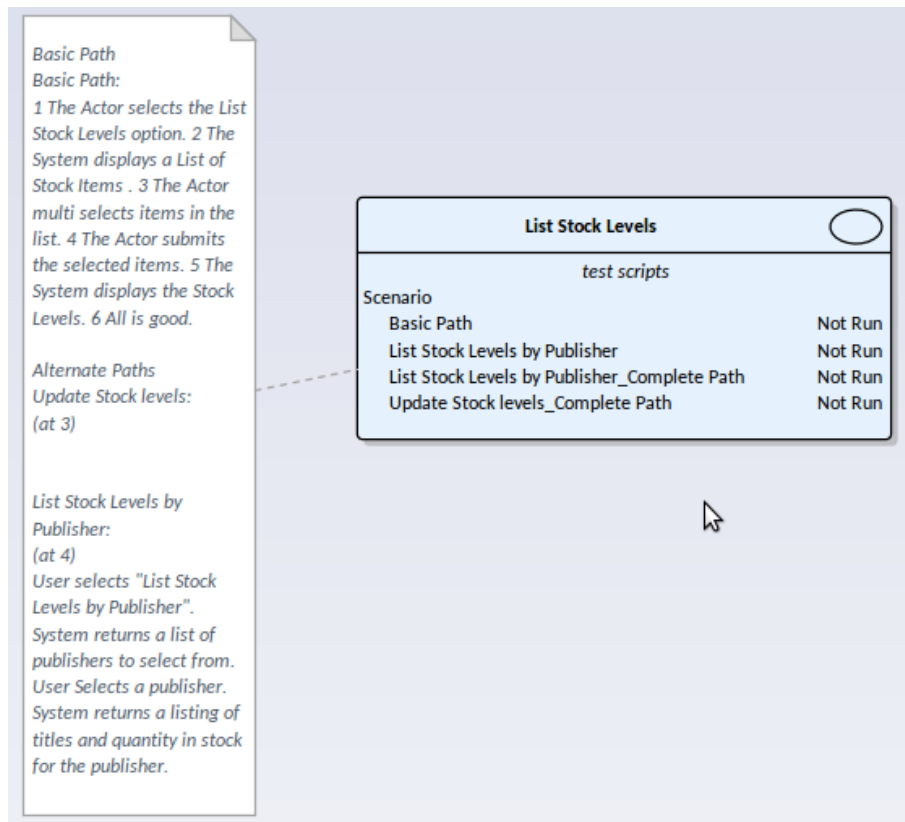

External Test Case

A Test Case element is created, linked to the selected element using the Trace connector.

A diagram is created under this Test Case element, to which the selected element, the Test Case element and a Note (showing the element's scenario specification) is added.

The created tests are displayed in the Test Scripts compartment of the Test Case

element on the diagram.

A test case is generated and added to the Test Case element for the basic path, and for each alternate and exception path.

In addition, for each step in the basic, alternate and exception paths that has a value in the 'Results' column, a test is generated and added to the Test Case element.

You can review the tests within the Test Case element using the Test Cases window, as for Internal Test Cases.

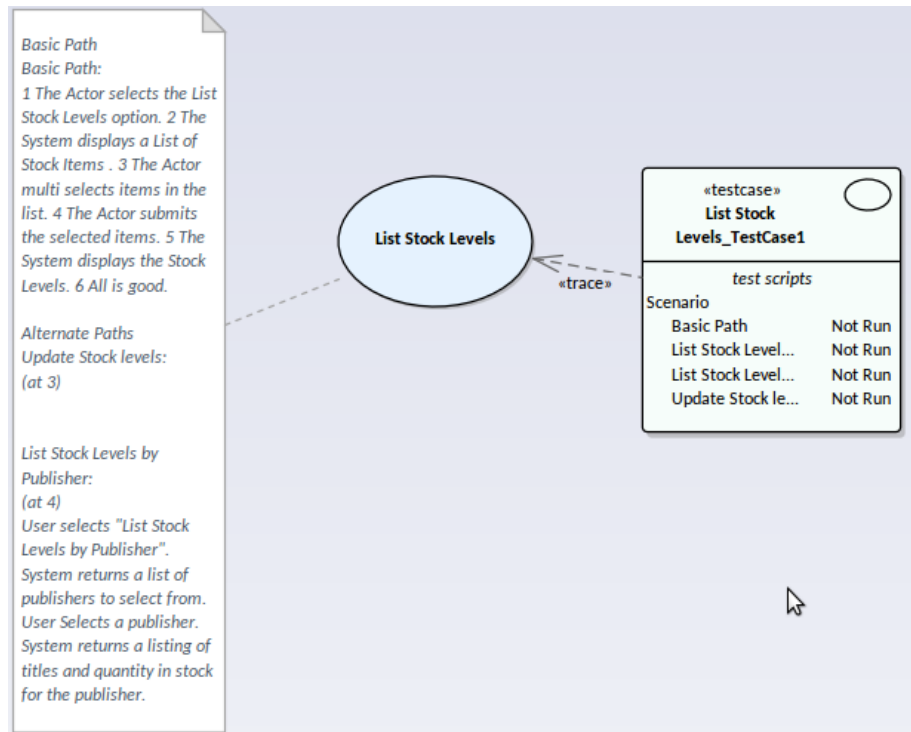

Scenarios View - Context References

As you create a structured specification in the Scenarios View for the element, you can use the 'Context References' tab to create and display a list of all elements that are either:

- Connected to the current element by any connector, on the current diagram or another, or
- Defined as a cross reference (or custom reference) on the current element

Access

On a diagram or in the Browser window, select an element, then use any of the methods outlined here to display the 'Select Element' dialog. Use the 'Select Element' dialog to locate and select the required cross reference element or elements. For each cross reference added through the 'Select Element' dialog, you can also use context menu options to delete the entry in the list, or to open the 'Comment' field so that you can add or edit comment text. Those options are grayed out for cross references added through the diagram. For each element in the 'Context References' list, wherever the name of that element appears in the structured specification, the name is highlighted and underlined; press the Ctrl key and click twice on the highlighted name to view the 'Properties' dialog for that element.

Ribbon	Start > Application > Edit > Responsibilities > Structured Scenarios >
--------	---

	Context References Right-click in panel Add Context Reference
Context Menu	<p>Inspector window > Details Right-click on 'Scenarios' New Scenario > Context References Right-click in panel Add Context Reference</p> <p>Inspector window > Details Scenarios right-click on existing scenario Structured Scenario Editor > Context References Right-click in panel Add Context Reference</p>
Keyboard Shortcuts	Alt+2 > Responsibilities > Structured Scenarios > Context References Right-click in panel Add Context Reference
Other	<p>On the 'Scenarios' tab of the Responsibility window, click on the Edit button against a scenario > Context References Right-click in panel Add Context Reference (see the <i>Scenarios Tab - Responsibility Window</i> Help topic)</p> <p>On the 'Scenarios' tab of the element 'Properties' dialog, click on the Structure Editor button > Context References Right-click in panel Add Context Reference (see the <i>Scenarios Tab -</i></p>

	<i>Properties Dialog Help topic)</i>
--	--------------------------------------

Scenarios View - Constraints

The Scenarios View 'Constraints' tab is a simple link to the 'Constraints' tab of the element's 'Properties' dialog. It lists existing constraints; if you select the toolbar icons or context menu options to add or edit a constraint, control switches to the 'Properties' dialog 'Constraints' page.

Access

On a diagram or in the Browser window, click on the element and select one of these access methods to display the Scenarios View, then click on the 'Constraints' tab.

Ribbon	Start > Application > Edit > Responsibilities > Structured Scenarios
Context Menu	Inspector window > Details Right-click on 'Scenarios' New Scenario Inspector window > Details Scenarios right-click on existing scenario Structured Scenario Editor
Keyboard Shortcuts	Alt+2 > Responsibilities > Structured Scenarios
Other	On the 'Scenarios' tab of the Responsibility window, click on the Edit button against a scenario (see the

Scenarios Tab - Responsibility Window
Help topic)

On the 'Scenarios' tab of the element
'Properties' dialog, click on the Structure
Editor button (see the *Scenarios Tab -
Properties Dialog* Help topic)

Associated Files

An element can be linked to one or more files external to the repository, using the 'Responsibilities > Files' tab of the element's 'Properties' dialog. Having created the link, you can open the file and read its content from this tab.

Access

On a diagram or in the Browser, select an element and:

Ribbon	Design > Element > Editors > Properties Dialog > Files
Context Menu	Right-click on the element > Properties > Properties > Files (In the 'Details' tab of the Inspector window) Right-click on Files New 'File'
Keyboard Shortcuts	Ctrl+4 > Files (tab of the Responsibility Window) Shift+Enter > Files ('Properties' dialog) Shift+Alt+F ('Properties' dialog) Alt+9 > Files : Shift+Enter

Manage File Links

Option	Action
Path/URL	<p>Displays the URL or the directory path and name of the file currently selected in the 'Files' list.</p> <p>To add a link to a file, click on the  button to display the 'Locate Files' browser and locate and click on the appropriate file name. Then click on the Open button.</p>
Type	<p>Click on the drop-down arrow and select the appropriate value to identify the file path as a local directory path or a web address.</p>
Size	<p>Displays the size of the file.</p>
Last Write	<p>Displays the date and time the file was last updated.</p>
Notes	<p>Type in any comments or notes on the link to the file.</p>
New	<p>Click on this button to clear the data entry fields so that you can add a new file link.</p>
	<p>Click on this button to save any new or</p>

Save	changed details on a linked file.
Files	Displays the list of linked files. Click on a file to select it.
Launch	Click on this button to open the selected file. Local files open in their default application and web files open in the default browser.
Delete	Click on this button to remove the link to the associated file. The link is deleted from the list immediately.

Notes

- Linked files are a good way to link elements to additional documentation and/or source code
- You can also insert hyperlinks to other files, in diagrams, and launch them directly from the diagram

Dynamic Preview View

The 'Dynamic Preview' view in the main work area helps you to instantly generate a document on a selected element, using one of a range of templates to immediately display the information you require in the most appropriate structure and format. The document can be printed, but is not stored electronically - it is dynamically generated for the current element whenever you select the view and when you change the template. You cannot edit the document contents in the view.

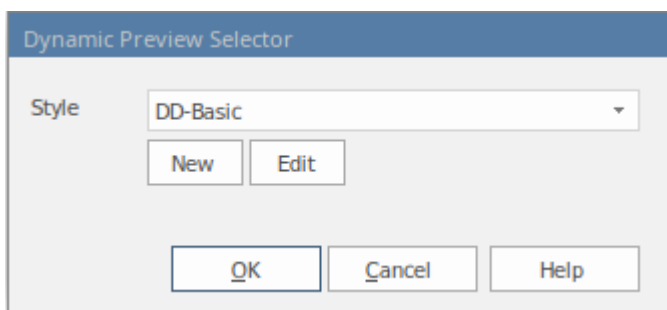

The 'Dynamic Preview' view is also the display screen for Reading List Artifacts. These Artifacts define a list of elements containing information that you should read consecutively. When you open the 'Dynamic Preview' view and select a Reading List Artifact, the view displays the text of the first element in the list. You can then select a 'Next' (and 'Previous') option to work through the Reading List of elements, displaying the text of each element in the defined sequence.

Access

--	--

Ribbon	Publish > Model Reports > Dynamic Preview
--------	---

Using the Dynamic Preview View

Initially, when you open the 'Dynamic Preview' View, it displays the Notes text from the currently-selected element, using the default Dynamic Preview style sheet.

If you want to display information for a different aspect of the element:

1. Click on the '[Reading] - <element name>' header
2. Click on the 'Select Dynamic Style' option. The 'Dynamic Preview Selector' dialog displays.

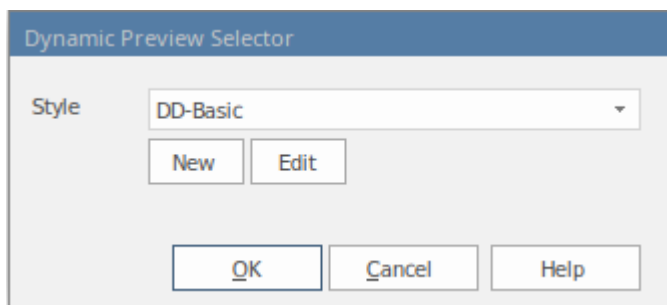

1. Click on the drop-down arrow in the 'Style' field and select one of the system-provided styles. These are designed to display information for specific aspects of relevant elements, such as Testing or Development.
2. Click on the OK button. The document is refreshed to show the required information in an appropriate format.

If the system-provided style templates do not support your requirements, you can quickly create your own style templates. A style template consists of one or more

command lines, each of which defines an element type (or all element types) and the document template to apply to the generated document. The document template can be:

- A system-provided template, or
- A system-provided fragment, or
- A user-defined template, or
- A user-defined fragment

Information on setting up a style template is provided in the *Manage Dynamic Preview* section.

Manage Dynamic Previews

Task	Description
Create Document Templates	Document templates are held in the 'Resources' tab of the Browser window, in the folder <i>Report Templates > Dynamic Previews</i> . Whilst you can select existing system or user templates and template fragments for your Dynamic Preview style template, you can also create new document templates or fragments specifically for Dynamic Previews. You could create these in the <i>Templates</i> or <i>Fragments</i> sub-folders of the <i>Report Templates > Custom Templates</i> folder, or you could create a

	<p>separate sub-folder within the <i>Dynamic Preview</i> folder.</p> <p>Whether you select existing templates or create new ones, you must enable the <i>Elements</i> section in each template or fragment you use.</p> <p>You would start to create the new document templates by either:</p> <ul style="list-style-type: none"> • Right-clicking on the <i>Templates</i> sub-folder (or other sub-folder) name in the <i>Custom Templates</i> folder and selecting the 'Create Template' option, or • Opening the 'Generate Documentation' dialog, clicking on the 'Templates' tab, and then clicking on the New button <p>In either case, the 'New Document Template' dialog displays, on which you specify the template name, type, source and group before going on to define the template contents.</p>
Create Style Templates	<p>Style templates are also held in the 'Resources' tab of the Browser window, in the <i>Dynamic Preview</i> folder.</p> <p>You can create a new style template:</p> <ul style="list-style-type: none"> • Via the 'Dynamic Preview Selector' dialog - click on the New button

- Via the 'Resources' tab of the Browser window - right-click on the *Dynamic Preview* folder name and select the 'Create Dynamic Preview Style' option

A prompt displays to enter the style template name; type the name and click on the OK button. The 'Dynamic Style' dialog displays, in which you type the style definitions, in the format:

```
<element  
name>:<stereotype>:<document template  
name>
```

If there is no stereotype, the format is:

```
<element name>::<document template  
name>
```

The <element name> is an IF argument, to state that if the 'Dynamic Preview' view is opened for an element of the defined type, the specified document template (or fragment) is used to format its documentation. If you want to use a specific template for information from an element of unspecified type (that is, a *defined* default) you would type:

```
Default::<document template name>
```

You could also apply the *system* default template for displaying information from an element of unspecified type, by just having the specified element statements

with no 'Default' statement at the end.
In this example, one template is defined to display information when the selected element is a Use Case, another for information from elements used by Project Support, a third for information from elements used in Database Engineering, and a fourth (a defined default) for information from any other kind of element.

UseCase::DD-UseCase

Change::DD-Support

Feature::DD-Support

Issue::DD-Support

Requirement::DD-Support

Risk::DD-Support

Task::DD-Support

Class:Table:DD-DB Table

Class:view:DD-DB SQL Element

Class:dbsequence:DD-DB SQL
Element

Class:function:DD-DB SQL Element

Class:procedure:DD-DB SQL
Element

	<p>Class:stored procedure:DD-DB SQL Element</p> <p>Class:trigger function:DD-DB SQL Element</p> <p>Class:functions:DD-DB SQL Element as Ops</p> <p>Class:sequences:DD-DB SQL Element as Ops</p> <p>Class:stored procedures:DD-DB SQL Element as Ops</p> <p>Class:procedures:DD-DB SQL Element as Ops</p> <p>Class:package:DD-DB SQL Element as Ops</p> <p>Artifact:sqlquery:DD-DB SQL Query</p> <p>Default::DD-Basic</p>
<p>Apply Style Templates</p>	<p>Having created a style template in the 'Resources' tab of the Browser window, you can immediately apply it to the information you display in the 'Dynamic Preview' view.</p> <p>As explained in the section <i>Using the Dynamic Preview View</i>, you click on the [Reading] header and on the 'Select Dynamic Style' option, and then click on the drop-down arrow in the 'Style' field.</p>

	<p>Your new style template will be listed with the system templates and other user-defined templates.</p> <p>Click on the style template to apply in the 'Dynamic Preview' view, and then on the OK button.</p> <p>The selected style will be applied to all documents shown in the 'Dynamic Preview' view until you specifically change it again.</p>
<p>Increase or reduce magnification</p>	<p>By default, the 'Dynamic Preview' view displays text as if it were printed on an A4 sheet. This is 100% zoom. If you want to change the display magnification, click on the [Reading] header and select the 'Fixed Zoom' option. This provides a small set of magnification options - '75%', '100%', '125%', '150%' and '200%'. It also provides a 'Custom' option; if you select this, a small dialog displays in which you type the percentage magnification you prefer, between 10% and 500%.</p> <p>When you click on the option, or the OK button on the small dialog, the selected magnification is applied to the display.</p> <p>The zoom factor remains set after you close the 'Dynamic Preview' view, and is</p>

	<p>applied when you re-open the view until you specifically change the zoom.</p>
<p>Display or hide page outline</p>	<p>The 'Dynamic Preview' view defaults to displaying information within the framework of a page, but you can toggle to a full-screen display by clicking on the [Reading] header and selecting the 'Toggle Page Border' option.</p>
<p>Scroll through elements</p>	<p>In the 'Dynamic Preview' view, you can display the information from a set of elements in sequence, using the 'Next' and 'Previous' options from the [Reading] header context menu. If you have selected a:</p> <ul style="list-style-type: none"> • Reading List Artifact element, the 'Next' and 'Previous' options display the information from the next or previous element in the <i>reading list</i>, wherever they might be in the model • Other type of element, the 'Next' and 'Previous' options display the information from the next or previous element in the parent element or Package, as listed in the Browser window; the options cannot scroll outside the containing object

<p>Edit Style Templates</p>	<p>You can edit a style template:</p> <ul style="list-style-type: none">• In the 'Resources' tab of the Browser window by right-clicking on the template name and selecting the 'Edit Dynamic style' option, or• In the 'Dynamic Preview' view by displaying the 'Dynamic Preiew Selector' dialog, selecting the style and clicking on the Edit button <p>In either case, the 'Dynamic Style' dialog displays, and you can delete or change the statements as necessary. Right-click on a line of text to display a context menu providing basic editing options.</p>
<p>Refresh the Display</p>	<p>To update the display with any changes made to the information within the selected element, click on the [Reading] header and select the 'Refresh' option.</p> <p>The 'Dynamic Preview' view with the 'Refresh' option is a useful tool for developing a document. You review the element's information in the view, make any changes you think appropriate within the element, then select the 'Refresh' option to immediately update the 'Dynamic Preview' view to show the changes. You can therefore check how a document generated from the element</p>

	would look, as you develop it.
Print the document	If you want to print a hard copy of the element's information, simply click on the [Reading] header and select the 'Print' option. The contents of the 'Dynamic Preview' view are sent to the system default printer

Select <Item> Dialog

The 'Select <Item>' dialog is a multi-purpose browser and search tool for locating model items such as Classifier elements, properties, attributes and behaviors. The <Item> in the dialog title changes to represent the type of item the original operation is working on.

The dialog is called in a range of operations; for example, setting:

- The base type or classifier for an Object, Swimlane or Lifeline
- Classifiers for the return types for operations
- Classifiers for generalization sets
- The Composite diagram for an element
- The Information Item or classifier elements conveyed or realized on an Information Flow
- The associated behavior for a behavior call
- The type and return type for operation parameters
- Activities for State transitions
- Use Case Scenarios
- Pattern element defaults
- Activities from which to generate code
- The values of Tagged Values

Multiple Selection

Where an operation permits the selection of multiple items,

the 'Select <Item>' dialog is automatically enabled to support this; to select the items, press the Ctrl key as you click on each item.

If you want to cancel a selected item, press the Ctrl key and click on the item. If you want to cancel selection of all items, just click on any item without pressing the Ctrl key

Having selected an item, you can continue to expand and browse the hierarchy, and/or search for items; the dialog retains the existing selections until you click on the OK button.

Select a required item

Step	Action
1	<p>During an operation, when it is necessary to locate an element or feature, click on the  button.</p> <p>The 'Select <Item>' dialog displays.</p>
2	<p>If required, in the 'Go To Namespace' field select a namespace to reduce the scope of the displayed hierarchy.</p> <p>The dialog opens the section of the hierarchy associated with that namespace, and closes all previously-open sections associated with other namespaces.</p>

3	<p>You can either:</p> <ul style="list-style-type: none">• Expand the selected area of the hierarchy on the 'Browse' tab, or any other Package, and locate the required item (go to step 5) or• Click on the 'Search' tab and, in the 'Find' field, type a partial or complete text string to search for the item
4	<p>On the 'Search' tab, you can filter the search further by selecting the 'Whole Word' and 'Match Case' checkboxes.</p> <p>Each list entry shows the name of the item, the type, any stereotype the item has, the immediate Package in which the item is held, and any successive parent Packages (the Package path).</p> <p>You can either:</p> <ul style="list-style-type: none">• Select the item immediately on the 'Search' tab or• Right-click on one item or a group of items and select the 'Locate item(s) in tree' option; this redisplayes the 'Browse' tab and highlights each selected item in the <namespace> hierarchy
5	<p>Click on the required item.</p>
6	<p>Click on the OK button.</p>

Notes

- When you have selected an item, the 'Select <Item>' dialog retains the context and item; next time you display the dialog, if the context is similar the dialog opens to the same Namespace and item - for example, if you have selected an activity for a State transition and you start to do the same for another transition, the dialog opens to the activity you previously selected
- If the context is totally dissimilar, the dialog opens with the Namespace < any > and a collapsed model hierarchy
- If the available items do not meet your requirements, you can create a new item and define the appropriate properties - click on the Add New button; the appropriate 'Add <Item>' dialog displays, on which you define the required item
- The Add New button is not always available, depending on the context and the type of item being searched for
- Elements can be searched by name or by alias on the 'Search' tab

Select Property Dialog

The 'Select Property' dialog is a specific instance of the 'Select <Item>' dialog; it is used to select Ports, Parts, attributes and Association Ends as redefined or subsetting properties, from a hierarchical list of Classes and their contained properties in the model. As an example, consider this section of the model:

Example

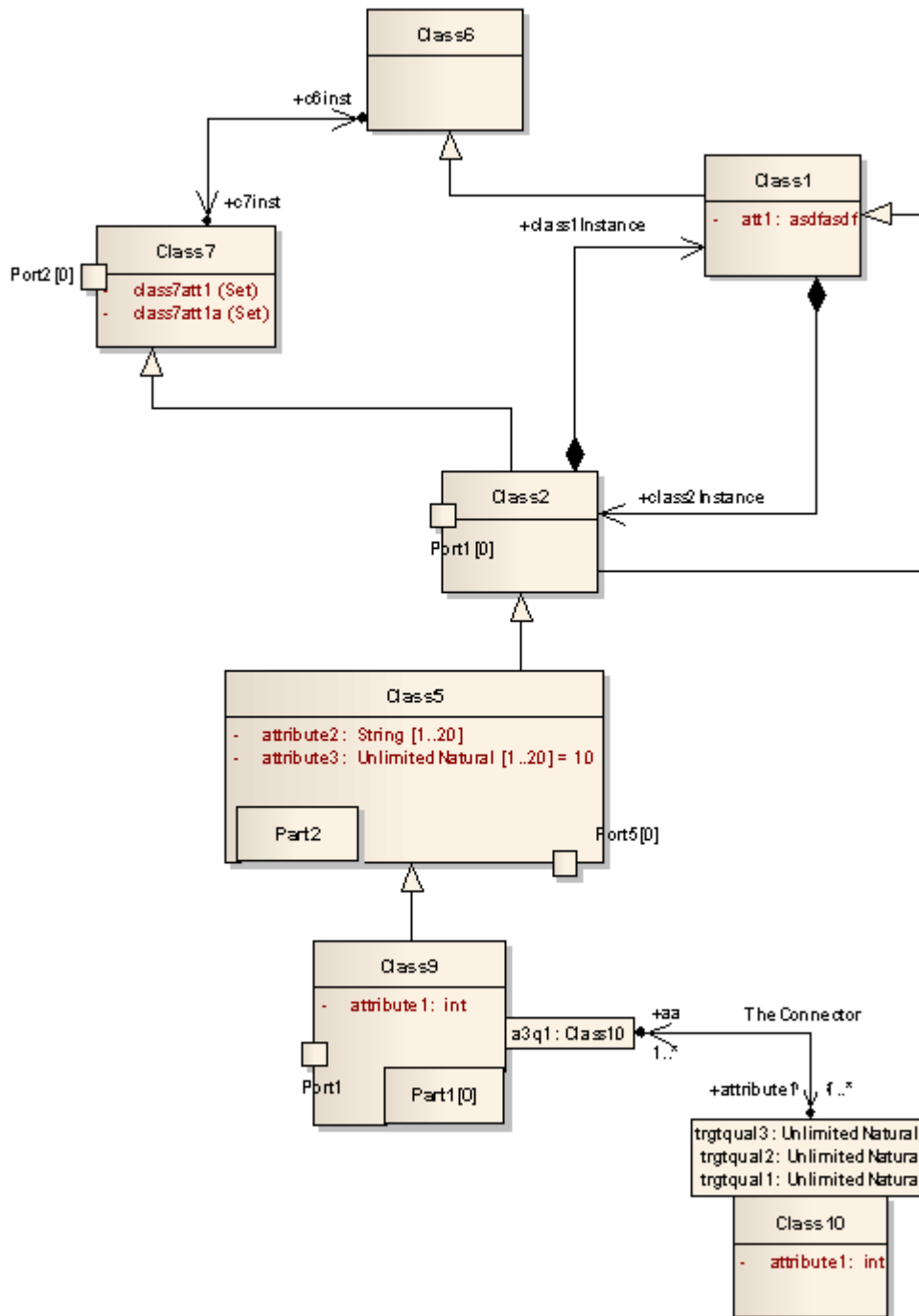

This would be represented in the dialog as shown:

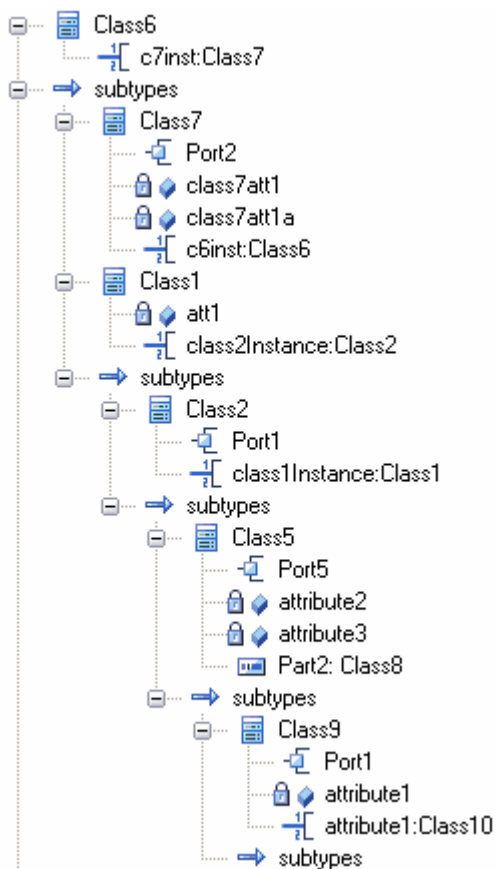

Locate and click on the required object to select it, then click on the OK button (to select several objects at once, press and hold Ctrl while you click on each object).

Notes

- AssociationEnds should be owned by the Class to be listed in the dialog

Set Feature Dialog

The 'Set Feature' dialog is the 'Set Operation' dialog used to change the operation represented by an Action on a diagram. As the 'Set Operation' or 'Set Attribute' dialog, it is also used to set the 'Value' operation or attribute for Tagged Values of type RefGUID or for the target of a hyperlink in a diagram.

Locate and select a value operation or attribute

Step	Action
1	The 'Set Operation' (or 'Set Attribute') dialog displays, with the model hierarchy opened at the point at which you selected the original operation or attribute.
2	If required, in the 'In Namespace' field, click on the drop-down arrow and select another model that contains the required operation or attribute. The Package hierarchy for that model displays.
3	Browse through the hierarchy, or use the 'Search' tab to locate the required operation or attribute, then double-click on the item to select it.

Element Context Menu Operations

You can perform a wide range of operations on element objects on a diagram, such as displaying an element's structural components, displaying or hiding its features on the diagram, and changing the element's appearance. You access these operations through the element context menu. If you are working under a technology such as SysML or BPMN, the menu can also provide options that are specific to that technology.

Access

Context Menu	Right-click on element on diagram
--------------	-----------------------------------

Element Context Menu Options

Option	Action
Specialize	Select this option to access a submenu of enabled Technologies on the system (for example, ArcGIS or TOGAF), each of which provides options for performing technology-specific operations on the

	element.
Collaborate	Select this option to display a short menu of options to exchange electronic notes with team colleagues, in the form of formal Reviews, informal Discussions, element Comments and, if User Security is enabled, Chats and Model Mail messages on the selected element.
Properties	Select this option to display a submenu of options for displaying different aspects of the properties and features of the element, including the: <ul style="list-style-type: none">• Properties window• A special dialog to define unique aspects of certain types of element (the 'Special Action' option); for State Lifeline and Value Lifeline elements, the 'Configure Timeline' dialog displays, and for a Required Interface element, the 'Exposed Interface' dialog displays; if there is no special dialog, the 'Properties' dialog displays• Notes window• Responsibility window (for Requirements, Scenarios, Constraints and Files)• The Properties window, select the

	<p>'Tags' tab to add or edit Tagged Values in the element</p> <ul style="list-style-type: none"> • Summary window • Document window (for Linked Documents and Dynamic Documents)
Features	<p>Select this option to:</p> <ul style="list-style-type: none"> • Display the appropriate page of the Features window to add attributes, operations or interaction points (structural elements such as Ports and Parts) to the element; for a Classifier that is the target of a Signal element, you can also add Receptions • Override any inherited attribute values set on the element • For an Object or State element, add a new instance variable to the element using the 'Define Run State' dialog • For elements that can have interfaces, show realized and/or dependent interfaces • For Database Table elements, define columns and constraints/indexes
Appearance	<p>Select this option to display a short menu of options to change and reproduce the appearance of the element.</p>

Linked Document	<p>(Corporate, Unified and Ultimate Editions) Select this option to create a document linked to the element.</p> <p>Shortcut: Ctrl+Alt+D</p>
Compartment Visibility	<p>Select this option to define the visibility of features and compartments on all selected elements.</p> <p>Shortcut: Ctrl+Shift+Y</p>
Set Bookmark Value	<p>Select this option to assign a bookmark to the selected element, to be displayed on the diagram.</p> <p>The 'Set Bookmark' dialog displays. Select the 'Enable Bookmark' checkbox and type in a numerical or text value for the bookmark, then click on the OK button. The value is displayed in a red circle or ellipse (depending on the length of the bookmark value) just above the element on the diagram.</p> <p>If you decide that you do not want the bookmark for a specific element to display on the diagram, return to the dialog and clear the 'Enable Bookmark' checkbox. You can hide (and redisplay) all bookmarks on a diagram using the 'Hide All Bookmark Values' (and 'Show</p>

	all Bookmark Values') option on the Diagram Context menu.
Insert Related Elements	Select this option to display the 'Insert Related Elements' dialog, to add elements related to the selected element to the current diagram.
Clone Element as New Version	Select this option to copy the structure of the selected element and paste it into the Browser window as a new element and contents; a prompt displays for you to enter a version number for the new element, followed by a browser on which you select its parent Package or element.
Advanced	Select this option to open the 'Advanced' sub-menu, which provides options for performing more complex or specialized operations on the element.
New Child Diagram	Select this option to display a submenu, listing - in order: <ul style="list-style-type: none"> • Options for creating and displaying the child diagram for a Composite element • For classifier elements, options to create Activity, Interaction, StateMachine or Rule Flow elements that encompass the appropriate type of

	<p>child diagram</p> <ul style="list-style-type: none"> • Individual types of child diagram (often technology-specific) that you might usually create for this type of element • An option to display the 'New Diagram' dialog to add any other type of diagram as the child diagram of this element
<p>New Child Element</p>	<p>Select this option to attach:</p> <ul style="list-style-type: none"> • One of a number of types of structural element, such as a Port, Part or Activity Parameter, to the selected element, or • A text element to the selected element, documenting a Note, Constraint, Rationale or Problem
<p>Simple Decision Table</p>	<p>This option displays for a selected Activity or Action element. Select it to display a sub-menu providing these options:</p> <ul style="list-style-type: none"> • Decision Table - Display, set up and edit the Decision Table for the element • Draw as Decision Table (Rules as Columns) - Replace the element shape on the diagram with its Decision Table, showing the decision rules as columns • Draw as Decision Table (Rules as

	<p>Rows) - Replace the element shape on the diagram with its Decision Table, showing the decision rules as rows</p> <ul style="list-style-type: none"> • Draw as Activity / Action - Where an element is rendered as a Decision Table on the diagram, re-display it as the normal element shape <p>The element is automatically sized to display the rule text; you cannot change the element size manually.</p> <p>If the selected element is a Rule Task element, the submenu option is 'Rule Composer', which invokes the Rule Composer in Business Rule Modeling.</p>
<p>Create Document to Artifact</p>	<p>(On an Artifact element linked to a Report Package or Model Document element). Select this option to generate a virtual document as the Linked Document of the Artifact element. The 'Generate Documentation' dialog displays.</p>
<p>Clear Checklist</p>	<p>Select this option to clear any selected checkboxes in the current Checklist Artifact element.</p>
<p>Checklist Spacing</p>	<p>Select this option to change the spacing between the items in the Checklist</p>

	<p>Artifact. A short list of spacing options displays, from which you select the required spacing.</p>
Find	<p>Select this option to display the 'Find' submenu, which provides options for:</p> <ul style="list-style-type: none">• Locating the selected element in other diagrams and in the Browser window, and• Setting up cross references (Custom References) to other elements
Copy/Paste	<p>Select this option to display a list offering these options for copying the selected element:</p> <ul style="list-style-type: none">• Copy - copy the element; you can select the 'Paste' option on the diagram context menu to paste the element into the diagram in a number of ways• Copy Image to Clipboard - copy the element image to the clipboard; you can use the 'Apply Image from Clipboard' option to recover and use the image elsewhere• Apply Image from Clipboard - paste the element image current held in the clipboard into the diagram as the image of the currently-selected element; the image is shown as a labeled frame

Behavior	<p>Select this option to display a short submenu, from which you:</p> <ul style="list-style-type: none">• Switch the element between Info View display style and 'normal' UML style• Set the element characteristics that are shown in Info View style• Toggle the Dockable, Selectable and Printable settings on the element• (Where an element has a structured element - such as a Port - shown in an element compartment) bind the Port to the compartment border rather than allowing it to move to any point on the parent element outline
Lock Element	<p>Select this option to lock the element so it cannot be edited; to unlock the element, select 'Lock Element' again.</p> <p>This does not apply in the Corporate, Unified and Ultimate Editions when security is enabled; in that situation, use the 'Lock' option for model elements.</p>
Z-Order	<p>Select this option to display a short submenu providing options to:</p> <ul style="list-style-type: none">• Move the element further back in the diagram

	<ul style="list-style-type: none">• Move the element further forward in the diagram• Put the element at the back of the diagram• Put the element at the front of the diagram
Type Information	Select this option to display the Help topic describing the type of element you have selected.
Delete <element name>	Select this option to delete the element from the diagram. The element still exists within the model and can be accessed from the Browser window. Shortcut: Ctrl+D

Notes

- If you select two or more elements at the same time, you can perform an operation on all of the selected elements at once; the operations available for multiple selection are provided on a separate context menu

Selectable, Dockable and Printable Options

The 'Selectable', 'Dockable' and 'Printable' options on the element context menu control several aspects of an element's behavior on a diagram.

The 'Behavior' option also provides access to the element Info View facility.

Access

Context menu	On a diagram, right-click on an element and select the 'Behavior' option.
--------------	---

Behavior Options

Option	Description
Selectable	Select or deselect this option to toggle whether the element is selectable or not: <ul style="list-style-type: none">• If an element is selectable, you can move it around the diagram and perform right-click context menu operations

	<ul style="list-style-type: none">• If an element is unselectable, you cannot move it around the diagram and the only right-click operation available is to make the element selectable <p>This option has no effect on double-click operations on the element, such as displaying child diagrams or 'Properties' dialogs.</p> <p>An element on a locked diagram is also unselectable - if you click on it, the element outline displays in red.</p> <p>In a diagram, you can filter the display to show selectable or non-selectable elements only.</p>
Dockable	<p>Select this option to align and join two elements either vertically or horizontally, on the current diagram only.</p> <p>Both elements must have the 'Dockable' option selected, and must have the joining edges parallel.</p> <p>As the distance between the elements narrows, the moving element snaps to the edge of the other element.</p> <p>For Activity Partitions, the option is selected by default.</p> <p>Deselecting the 'Dockable' option does not separate the elements; if necessary,</p>

	<p>you can simply move the elements apart again.</p>
Printable	<p>Defaults to selected, so that the element is depicted in any diagrams in reports generated on its parent Package.</p> <p>If you click on the option to deselect it, the element and its connectors will not be visible in any diagrams in reports. You can, however, deselect a report option for an instance of a report to force the display of non-printable elements.</p> <p>Deselecting this option also hides the element and its connectors in the 'Print Diagrams', 'Print to PDF' and 'Save Diagram as Image' operations.</p>

Advanced Operations on Elements

You can perform a wide range of more specialized functions on an element, specific to the element type and its relationship to other modeling objects.

Access

Context Menu	Right-click on element on diagram Advanced
--------------	--

Advanced Options

Option	Action
Instance Classifier	(For an instance or Object element) Select this option to set the instance classifier for the element, on the 'Select <Item>' dialog. Shortcut: Ctrl+L
Parent	(For a classifier element that can be generalized) Select this option to set the element's parent. Shortcut: Ctrl+I

Show element classifier	Shows or hides the classifier names on Port elements.
Classifier Properties	(For an instance or Object element) Select this option to open the 'Properties' dialog for the classifier of the selected element. Shortcut: Ctrl+Alt+Enter
Change to State (Value) Lifeline	(For a State Lifeline or Value Lifeline element) Select this option to switch one type of Lifeline element to the other.
Set Property Type	(For a Part element) Select this option to browse for and select the element that defines the Part type, using the 'Select <Item>' dialog.
Multiplicity	Select this option to define the multiplicity for the element, using the format defined on the 'Cardinality Values' tab of the 'UML Types' dialog ('Settings > Reference Data > UML Types'). This is the number of instances of the element that can exist in a set; the value displays on the element in a diagram, in the 'Name' compartment.

Port Size Customizable	(For a Port element) Select this option to allow users to resize the Port from the default size. If the option is not set, the element size cannot be changed.
Show Element Type	(For a Port or Part element) Select this option to toggle between displaying and hiding the element type, as set using the 'Set Property Type' option or on the 'Property' tab of the element's 'Properties' dialog.
Set Property Values	(For a Part element) Select this option to set the property value for the Part, using the 'Set Property Values' dialog. Shortcut: Ctrl+Shift+R
Edit Extension Points	(For a Use Case element) Select this option to display the 'Use Case Extension Points' dialog, which you use to insert the point at which the behavior should be inserted.
Association Class	(For a Class element) Select this option to connect the Class to a new Association.
Use Rectangle	(For an element that uses non-rectangular notation) Select this option to apply

(Circle, Actor) Notation	rectangle notation to the element (and switch back again).
Partition Activity	(For an Activity element) Select this option to define an Activity Partition in the element.
Set Object State	(For an Object or instance element) Select this option to set the state of the element based on the child states of its classifier. Shortcut: Ctrl+Shift+S
Override Attribute Initializers	(For a Class element with attributes) Select this option to pre-define initial values for attributes that can be used to override existing defaults. Shortcut: Ctrl+Shift+R
Convert to Instance (Property/Invocation)	Select this option to convert a classifier to an instance, property or invocation, depending on the type of classifier selected (for example, SysML classifiers are always converted to properties).
Convert Linked Element To	Select this option to convert the occurrence of the element on the current diagram from a link to the original

Local Copy	element to a local copy of the element. A copy of the element is also added to the diagram's parent Package in the Browser window.
Make Sender/Receiver	(For Send and Receive Event elements) Select this option to toggle the element from a sender to a receiver and vice versa.
Accept Time Event	(For a Receive element) Select this option to change the notation from an Accept Event action to an Accept Time Event action.
Define Concurrent Substates	(For a State element) Select this option to define the set of substates that can be held simultaneously within that composite State.
Use State Label Notation	(For a State object) Select this option to switch to State Label Notation (the element name is displayed on a box on top of the element rather than inside it).
Deep History	(For a History pseudostate) Select this option to change the type of a shallow History pseudostate to a deep History pseudostate.

Transform	<p>Select this option to transform the selected element from one domain to another.</p> <p>Shortcut: Ctrl+H</p>
Set Attached Links	<p>(For a Note element) Select this option to attach the element to a connector, or several connectors on the diagram.</p>
Link to Connector Constraints	<p>(For a Note element) Select this option to display the connector type and to list the constraints of the associated connector in the Note element.</p>
Link to Connector Notes	<p>(For a Note element) Select this option to display or hide the text assigned to a connector's 'Notes' field.</p>
Link to Connector Tagged Values	<p>(For a Note element) Select this option to display the connector type and to list the Tagged Values of the associated connector in the Note element.</p>
Link to Diagram Notes	<p>(For a Note element) Select this option to display the diagram notes as the text of the Note element.</p> <p>Any current text is deleted and the Note is blocked from being edited other than</p>

	through the 'Notes' field in the diagram 'Properties' dialog.
Hide (Show) attached links	(For a 'Memo' style or 'Memo2' style Note element) Select this option to hide or show the Notelink connectors to the elements to which the Note refers.
Vertical Partition	(For an Activity Partition element) Select this option to switch a horizontal Partition to a vertical Partition.

Notes

- Context menus vary between element types, and few of the menu options shown here are present on all element context menus; 'Tagged Value' is often the only option available
- If an element appearance is overridden by a Shape Script, several of the appearance options are disabled; for example, 'Use Rectangle (Circle) Notation'

Finding Elements

When you have selected an element on a diagram, you might want to find out where it is held in the model structure, where else it is used in the model, and how to locate it easily in the future. For these operations, you can select the 'Find' submenu.

Access

Ribbon	Design > Element > Manage > Find in Diagrams Design > Element > Manage > Find in Project Browser
Context Menu	Right-click on element Find (see <i>Find Options</i> for a description of the sub-menu).
Keyboard Shortcuts	Alt+G (find in Browser window) Ctrl+U (find in all diagrams)

Find Options

When 'Find' is selected from the context menu, a sub-menu is displayed, providing options as described here.

Option	Action
Locate in State Table Locate in State Chart	For a State element, select this option to switch from one diagram display format to the other, and highlight the element.
In Project Browser	Select this option to highlight the currently selected element in the Browser window. Shortcut: Alt+G
Locate Classifier In Project Browser	For an instance or Object, select this option to highlight the classifier for that element in the Browser window. Shortcut: Ctrl+Alt+G
Locate Operation in Project Browser	For an Action element, select this option to highlight the call operation for that element in the Browser window. Shortcut: Ctrl+Alt+G
Find in all Diagrams	Select this option to list the other diagrams in which the element is also used, on the 'Element Usage' dialog. Shortcut: Ctrl+U
Custom	Select this option to identify and, if

References	necessary, open the 'Properties' dialog for any elements that are the target of a cross reference from the selected element. Shortcut: Ctrl+J
Add to Favorites	Select this option to add the selected element to the <i>Favorites</i> folder in the 'Resources' tab of the Browser window.

Changing Element Appearance

If you want to modify the appearance of a specific element on a diagram, you can use a range of facilities available through the element context menu on the diagram.

Some of these facilities are also available via the Layout ribbon's Style panel, or through the Format toolbar.

Access

Ribbon	Layout > Style (changes the appearance of the selected element on the current diagram only)
Context Menu	Right-click on the element on the diagram and select the 'Appearance' option; this displays the 'Element Appearance' sub-menu, described here.
Keyboard Shortcuts	F4 (displays the 'Default Appearance' dialog, described here)
Other	Right-click on the element on a diagram - the Format toolbar is displayed above the context menu. (The Format toolbar changes the appearance of the selected element on the

	current diagram only.)
--	------------------------

Element Appearance Options

Option	Action
<p>Default Appearance</p>	<p>Click on this option to override the global default appearance of all elements (which you set on the 'Standard Colors' and 'Diagram Appearance' pages of the 'Preferences' dialog) with a different default for just the selected element on all diagrams in which it is used.</p> <p>To change the appearance of the selected element on the current diagram only, use the tools available in the 'Style' panel of the 'Layout' ribbon.</p> <p>Shortcut: F4</p>
<p>Apply Image From Clipboard</p>	<p>Click on this option to paste the image held on the clipboard onto the selected element, as an alternative image.</p> <p>This image is added to the Image Library under an automatically-assigned name. The image can be accessed from and renamed in the Image Manager.</p>

Select Default Image	<p>Click on this option to change the element's appearance to an alternative image, using the Image Manager.</p> <p>This appearance applies to the element on all diagrams in which it is used.</p>
Select Alternate Image	<p>Click on this option to change the element's appearance to an alternative image, using the Image Manager.</p> <p>This appearance applies to the element on the current diagram only.</p> <p>Shortcut: Ctrl+Shift+W</p>
Select Image Asset as Alternate Image	<p>Click on this option to display the 'Select Element' browser, and locate an Image Asset element containing the image to use for the selected element.</p>
Hide/Show Name Under Image	<p>For an element that has an alternative image, click on this option to hide or redisplay the name label under the element.</p>
Set Font	<p>Click on this option to change the font type, size, color and effects for the text in the element.</p>
Diagram Frame	<p>For Diagram Frame elements; click on this option to set the appearance of the</p>

Appearance	frame.
Show Labels	<p>For embedded elements, or those with an alternative image that show element properties as labels, click on this option to reveal the hidden labels on the element.</p> <p>(The option is not listed if there are no hidden labels.)</p>
Standard Memo Memo (Style 2) Pin Sticky Paperclip	<p>For a Note element, click on one of these options to apply the corresponding image to the element.</p>
Copy Appearance to Painter	<p>Click on this option to copy the default element appearance (set using the 'Default Appearance' option) to the painter.</p> <p>You then paste the default appearance using the 'Paste Appearance' option on the Diagram toolbar.</p>
Copy Image to Clipboard	<p>Click on this option to copy the element image to the clipboard. You can use the</p>

	'Apply Image from Clipboard' option to recover and use the image elsewhere.
--	---

Notes

- You can also change the appearance (and other aspects) of several selected elements at once
- Context menus vary between element types, and not all menu options shown here are present on all element context menus; for example, the 'Select Alternate Image' option does not display for a Lifeline element

Operations on Multiple Elements

It is possible to perform various operations on two or more elements on a diagram at once, either to add the same feature or to standardize the size or orientation of the selected elements. This makes it much faster to update the diagram than if you had to modify each element separately.

To select the required elements, either click and drag the cursor over the group to highlight them, or press Ctrl or Shift as you click on each element separately. You can 'fix' this selection permanently using the 'Group' elements option on the context menu.

The selected element that is drawn with a hatched border is the context element. The context element is used as the 'master' element when aligning or resizing elements as a set.

The Shift and Ctrl keys toggle selection, so if you want to exclude a selected element from a group, again press the key as you click on the element. The two keys have a slightly different effect when you click on the intersection between two overlapping elements:

- Shift+click toggles selection of the element with the lower Z-order (the element behind or further back than the others)
- Ctrl+click toggles selection of the element with the higher Z-order (the element in front of or further forward than the others)

Access

Select a set of elements on a diagram, then right-click on one of the selected elements to display a context menu (for format/layout operations, right-click on the element against which to standardize the others - this sets the right-clicked element as the context element). Just note that if you click (not right-click) on an individual element, that element becomes the only selected element; the multiple selection is cleared and you are no longer working on multiple elements. The 'Layout' ribbon's 'Style' panel also provides options for changing appearance related properties for a set of selected elements, while the 'Alignment' panel provides numerous options for aligning and resizing elements.

Ribbon	<p>Layout > Style (changes the appearance of the selected elements on the current diagram only)</p> <p>Layout > Alignment (changes the size or position of the selected elements on the current diagram only)</p>
Context Menu	Right-click on a selected element on a diagram. The context menu for multiple selections displays; this is described here.
Keyboard Shortcuts	F4 (displays the 'Default Appearance' dialog, described here)
Other	Right-click on a selected element on

	<p>diagram - the Format toolbar is displayed above the context menu</p> <p>(Changes the appearance of the selected elements on the current diagram only)</p>
--	--

Options

Option	Detail
Specialize	<p>Select this option to access a submenu of enabled Technologies on the system (for example, ArcGIS or TOGAF), each of which provides options for performing technology-specific operations on the elements.</p> <p>This option is available in the Professional, Corporate, Unified and Ultimate Editions of Enterprise Architect.</p>
Collaborate	<p>This option displays if User Security is enabled. It offers the sub-options of:</p> <ul style="list-style-type: none"> 'Send Message', which opens the 'Create Message' dialog to create and send a model message containing a hyperlink to each of the selected objects

	<ul style="list-style-type: none"> • 'Monitor Discussions', which sets a flag on the selected elements to notify you if any of the selected elements are the subject of a new discussion or a new reply to an existing discussion
Align	<p>Select one of these 'Align <point>' options to align elements against the 'master' element's:</p> <ul style="list-style-type: none"> • left edge • right edge • top edge • bottom edge • center, vertically or • center, horizontally <p>You can also edge-align groups of elements using the Diagram Toolbar; the four alignment buttons are made available when more than one element is selected in a diagram.</p> <p>Shortcut:</p> <p>Ctrl+Alt+Left Arrow Ctrl+Alt+Right Arrow Ctrl+Alt+Up Arrow Ctrl+Alt+Down Arrow</p>
Space Evenly	(For three or more selected elements.)

	<p>Select this option to automatically even out the spacing between the selected elements, either horizontally or vertically.</p> <p>Shortcut: Alt+- Alt+=</p>
Same Height/Width	<p>Select one of these options to make all the selected elements match the 'master' element's height or width, or both.</p> <p>In Use Case diagrams, these options are blocked if the 'Allow elongated Use Cases' option is turned off on the 'Preferences' dialog 'Objects' page.</p>
Group/UnGroup Elements	<p>Select these items to either combine the selected elements into a group for common formatting, for a number of work sessions, or to cancel an existing group.</p>
Compartment Visibility	<p>Select this option to define the visibility of features and compartments on all elements selected on a diagram.</p> <p>Shortcut: Ctrl+Shift+Y</p>
Set Bookmark Value	<p>Displays the 'Set Bookmark' dialog, on which you enable the display of Bookmark icons above the selected elements, and set any value to display in those bookmarks.</p>

Show Elements Matrix	Displays a Relation Matrix for two selected elements, identifying relationships between the features of the elements in the selected group.
Clone Element(s) as New Version	Select this option to copy the structure of the selected elements and paste them into the Browser window as new elements and contents; a prompt displays for you to enter a version number for the new elements, followed by a browser on which you select the parent Package or element.
Add Tagged Value	Select this option to add the same Tagged Value to all selected elements.
Autosize	Select this option to automatically resize the selected elements to their default minimum size (element content permitting). Shortcut: Alt+Z
Appearance	Select this option to set the same default appearance and font for all of the selected elements at once. Shortcut: F4 You can also enable the Custom Diagram

	Style on the grouped elements, enable Info View style, and define the Info View display options.
Behavior	Select this option to display a short submenu, from which you toggle the Dockable, Selectable and Printable settings on the elements
Copy	Select this option to copy the selected elements to the clipboard.
Save Selected Elements as Pattern	Save the selected elements in a DiagramPattern Artifact, to act as a Pattern to reproduce those elements in other diagrams.
Layout Selected Elements	Select this option to automatically adjust the layout of the selected elements on the diagram.
Delete Selected Elements	Select this option to delete the selected elements from the diagram only. Shortcut: Ctrl+D

Linked Documents

When you are developing elements in your model, you might want to provide extensive documentation on an element, to provide more structured text than you can create in the element 'Notes' field. In this case, you can create a formatted document that is linked to the element. You can create a Linked Document from scratch, or from one of a range of Linked Document Templates that you define with the Linked Document Template Editor. The Linked Documents are held within the model.

Working with Linked Documents

Task	Detail
Create Linked Documents	<p>You can create a Linked Document either:</p> <ul style="list-style-type: none">• Within a Document Artifact element attached to your model element, or• Directly on the model element <p>The advantages of using a Document Artifact to host the Linked Document include:</p> <ul style="list-style-type: none">• Visibility of the Document Artifact and hence Linked Document in the Browser window• As you can only have one Linked

	<p>Document in an element, hosting each of several documents in its own Document Artifact and connecting the several Document Artifacts to one model element means that you have broader scope for providing information</p> <ul style="list-style-type: none"> • Similarly, associating several elements with one document by connecting them to the host Document Artifact element means that you can share information rather than duplicating it <p>The advantages of using a Linked Document directly on an element include:</p> <ul style="list-style-type: none"> • More tightly binding the content of the document to the element, so there is less ambiguity in what the information refers to • More tightly binding the document itself to the element, so there is less risk of the document being changed, moved or deleted without reference to the element it belongs to
<p>Create Linked Document templates</p>	<p>You can base your Linked Document on one of a range of system-provided templates, each of which represents a project document type.</p> <p>You can also create and use your own</p>

	<p>Linked Document templates in the 'Resources' tab of the Browser window, within the <i>Linked Documents</i> folder.</p>
<p>Edit Linked Documents</p>	<p>You can define the style, format and layout of your Linked Document both in the template from which you create the document and in the document itself. You can edit the Linked Document from a selected element in the Document Window and in the Linked Document Editor.</p>
<p>Create hyperlinks in Linked Documents</p>	<p>Linked Documents are intimately associated with specific elements, but you can also create hyperlinks in the document directly to other elements in the model. Having followed the link, you can perform any normal operation on that element.</p> <p>Similarly, you can create new elements or diagrams to link to.</p> <p>You can also create hyperlinks to other forms of documentation.</p>
<p>Include Linked Documents in RTF</p>	<p>Linked Documents, however they are created, are rendered into document reports when you select the 'Linked Document' checkbox in the Document</p>

reports	Template Designer.
Locate Linked Documents	<p>In diagrams, any element that has a Linked Document is marked with an 'A' symbol in the bottom right corner.</p> <p>You can also use the Model Search facility to search for elements that have Linked Documents, either using the 'Find Linked Documents' search in the 'Publish' group of system-defined searches (returning standard Linked Documents), or by creating a custom search containing this SQL Query (which returns all variations of Linked Document):</p> <pre>SELECT ea_guid AS CLASSGUID, Object_Type AS CLASSTYPE, Name AS Object, Object_Type AS [Type], Stereotype, Author, Scope, Status, Phase, CreateDate, ModifiedDate FROM t_object WHERE t_object.Style LIKE '#WC#MDoc=1#WC#'</pre>
Delete Linked Documents	<p>You can completely remove a Linked Document from an element, or you can remove the contents of the document and replace them with the contents of an external file.</p>

Notes

- You can create a Document Artifact element to contain a Linked Document in all editions of Enterprise Architect
- You can create and link a document to any UML element in the model, in all editions of Enterprise Architect
- You can work on Linked Documents through the Automation Interface, using the methods `GetLinkedDocument()`, `DeleteLinkedDocument()`, `SaveLinkedDocument(string Filename)` and `LoadLinkedDocument(string Filename)`

Create Document Artifact

You can create a Document Artifact element to host a Linked Document for another model element. You can either create an appropriate connector between the Document Artifact and the documented element (to indicate how the document impacts the element), or drag the Document Artifact over the model element on the diagram or in the Browser window so that it becomes a child of the model element. Alternatively, if the document is not specific to a model element, you can leave the Document Artifact as an independent element in an appropriate location.

Create a Linked Document in a Document Artifact

Step	Action
1	Open the diagram containing the element for which to create the Linked Document.
2	Open the 'Documents' page of the Diagram Toolbox. Drag and drop the Document Artifact element icon from the Toolbox into your diagram.
3	Double-click on the Document Artifact element. A default blank-page document opens in the Linked

	<p>Document Editor, based on the Normal.rtf style template.</p> <p>Alternatively, click on the Artifact and select the 'Start > Application > Design > Document' ribbon option. A default blank-page document opens in the Document Window, based on the Normal.rtf style template.</p>
4	<p>Apply a template and/or continue to develop the Linked Document as described in the <i>Create Linked Document on an Element</i> topic, from step 2 onwards.</p>

Notes

- As another alternative, you can create a File Artifact element containing a document file that you have dragged from a file browser onto an Enterprise Architect diagram; see the *Create File Artifacts* Help topic
- There is a limit of one Linked Document per Document Artifact element, but you can provide more than one Linked Document for a model element by linking it to more than one Document Artifact
- This operation is available in all editions of Enterprise Architect
- When you have saved the document, an A symbol displays in the bottom right corner of the element

Create Linked Document on an Element

If you need to provide more extensive and structured documentation on an element, you can develop this as a formatted document directly linked to the element. You can develop the document from a blank page or using a system template or user-defined template, at several different points in the work area.

Access

Select an element in the Browser window, Diagram List, Package Browser, Specification Manager, Model Search or diagram, then use any of the methods outlined here to open the Document window or Linked Document Editor. Both features activate the 'Document - Edit' ribbon, which you use to enter and edit the text of the Linked Document.

Ribbon	<p>Start > All Windows > Design > Create > Document (Document window)</p> <p>Design > Element > Properties > General > Document (Document window)</p> <p>Design > Element > Manage > Edit Linked Document (Linked Document Editor)</p>
Context	Right-click on the element name

Menu	Properties Linked Document (Document window)
Keyboard Shortcuts	Ctrl+Alt+D (Linked Document Editor) Alt+1 > Document (Document window) Alt+5 > Document (Document window)

Create a Linked Document

Step	Action
1	<p>The Linked Document Editor automatically opens in edit mode.</p> <p>The 'Linked Document' tab opens in Read mode; click on the  icon and select the 'Edit Mode' option. A default blank-page document opens, based on the <i>Normal.rtf</i> style template.</p> <p>The 'Document - Edit' ribbon also displays in the Ribbon Bar.</p>
2	<p>If you do not want to apply a system template or user-defined template, go to step 6.</p> <p>If you do want to base the document on a selected template, select the 'Document - Edit > File > File > New (Clear Document)' ribbon option. A prompt</p>

	<p>displays for you to confirm that you are clearing the current document; click on the OK button.</p> <p>The 'New Linked Document from Template' dialog displays.</p>
3	<p>In the 'Template' field, click on the drop-down arrow and select the template from which to create the document.</p> <p>This can be either a system-supplied template or a template that you have previously created yourself.</p>
4	<p>If you want to display the 'New Linked Document from Template' dialog by default whenever you start to create a Linked Document, select the 'Show this dialog on document creation' checkbox.</p> <p>If you no longer want to display the dialog by default, deselect the checkbox.</p>
5	<p>Click on the OK button.</p> <p>The new Linked Document opens. If you have based the document on a selected template, the document shows the content applied by the template.</p>
6	<p>Enter and format the text of the document, using the facilities of the 'Document - Edit' ribbon.</p>

Notes

- You can create only one Linked Document on an element; if you need to create more, develop each document within its own Document Artifact element and link these to the model element
- This operation is available in all editions of Enterprise Architect
- When you have saved the document, an  symbol displays in the bottom right corner of the element

Edit Linked Documents

To develop the contents of a Linked Document, you use either the Document Window or the Linked Document Editor. These provide a frame for working on the document, using a wide range of convenient features from the Document - Edit ribbon. The features help you in formatting and editing the document, and adding links from and references to the content of the document.

In the Linked Document Editor some editor features are duplicated in a right-click context menu for convenience.

The Document Window has additional facilities, as described in the *Linked Documents in the Document Window* Help topic.

Access

Select an element in the Browser window, Diagram List, Package Browser, Specification Manager, Model Search or diagram, then use any of the methods outlined here to open the Linked Document.

Ribbon	Explore > Portals > Windows > Properties > Document Start > All Windows > Design > Create > Document Start > All Windows > Properties > General > Document
--------	--

	Design > Element > Properties > General > Document
Context Menu	Right-click Properties Linked Document
Keyboard Shortcuts	Ctrl+Alt+D
Other	From the Notes window or from the 'Notes' field of the element 'Properties' dialog, click on the  icon on the Notes toolbar.

Option Descriptions

The Linked Document Editor option descriptions are grouped according to the actions you are performing.

Action
Creating and importing documents
Configuring the editor page display and formatting tools shown
Incorporating stylesheets, special texts and Tables of Contents

Managing the base styles in the Normal.rtf style template file

Moving through, searching and selecting text

Formatting characters and text strings

Formatting paragraphs and text blocks

Inserting tab points

Inserting sections, columns and page breaks, and repaginating

Inserting and editing page headers and footers, and footnotes and endnotes

Inserting tables

Inserting hyperlinks

Inserting images, OLE objects, frames and drawing objects

Printer set up and printing documents

Checking spelling and use of words

Tracking, accepting and rejecting changes to text

Protecting document text from accidental change

Create and refer to definitions of Glossary terms in the Project Glossary (using the 'Create | Glossary Definition' menu option)

Notes

- Throughout your document editing:
 - To undo one or more immediately previous edits, press Ctrl+Z, or select the 'Undo' ribbon or context menu option; you can still undo a change even after you have saved the change
 - To redo one or more immediately previous undone edits, press Ctrl+Y, or select the 'Redo' ribbon or context menu option

Linked Documents in the Document Window

The Document window provides several quick methods of checking elements for Linked Documents, and for reviewing the documents that exist. It also provides searches to locate and list any elements with Linked Documents in the model, and any elements that have Linked Documents that have been recently modified.

When you click on an element in the Browser window, a diagram or an element list - such as the results of a search - the Document window displays the name of the selected element and, if it has a Linked Document, the content of that document. If the element does not have a Linked Document, the content panel is blank. If you click on another element, the window updates immediately to show the element name and Linked Document (if any) of that element. You can therefore quickly scan a number of elements to check whether they have Linked Documents, and/or review the documents you locate. The 'Linked Document' tab provides options for reviewing the Linked Document, including switching to an Edit mode so that you can create or update the document.

Note that there are also options for creating a Linked Document via the Linked Document Editor, which is an alternative method. See the *Edit Linked Documents* Help topic.

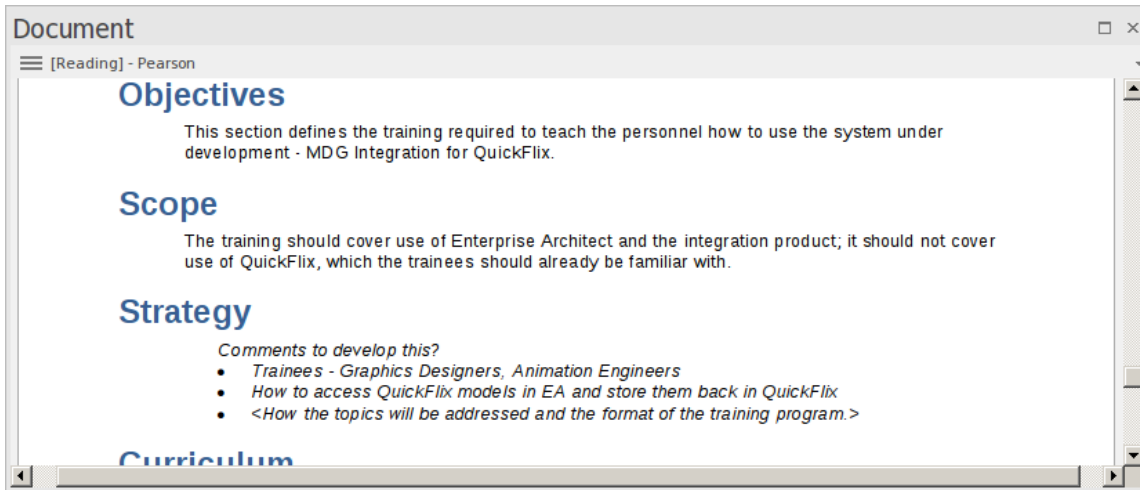

Access

<p>Ribbon</p>	<p>Start > All Windows > Design > Create > Document</p> <p>Start > All Windows > Properties > General > Document</p> <p>Design > Element > Properties > General > Document</p>
<p>Context Menu</p>	<p>Right-click on the element name Properties Linked Document</p>

View Document

When you first open the Document window, it shows the selected element's Linked Document in Reading (View) mode. The element name displays in the menu button at the

top of the window, with the prefix 'Reading'. Click on the menu button to access these options:

Option	Description
Edit Mode	<p>Switches the document into 'Edit' mode and displays the 'Document - Edit' ribbon, which provides the facilities for updating the document. If the element does not currently have a Linked Document, you can immediately start typing in the display panel or import a file to create a Linked Document for the element.</p> <p>If the selected element is locked, the menu button displays the text '[Locked] - <element name>', and you cannot edit the Linked Document. Similarly, if you have edited the document but not yet saved the changes, the menu button displays an asterisk in front of the element name: for example, *PersonClass.</p> <p>While in edit mode, the Document window becomes locked to the parent element, and selecting another element or context will not switch the window to a different document. This helps you to move around the model, checking and gathering information without having to close and open the document several times. Once you quit edit mode, the</p>

	<p>window will again immediately refresh to show the document for whichever element you select. To switch out of 'Edit' mode, click on the menu button and deselect the option.</p>
Lock Element	<p>Locks the element against changes - including changes to the Linked Document. Deselect the option to unlock the element and allow changes.</p>
Reload	<p>Refreshes the content of the displayed document from the last-saved version.</p>
Find in Project Browser	<p>Expands the Browser window and highlights the Linked Document's parent element.</p>
Find in Diagrams	<p>Opens the diagram containing the Linked Document's parent element, with the element selected. If the element exists in more than one diagram, the 'Element Usage' dialog displays, from which you can select the diagram to open.</p>
Fixed Zoom	<p>Displays a short list of magnifications (as a percentage of 'normal' size) you can select to zoom the document display to, as well as a 'Custom' option that opens a</p>

	<p>dialog on which you can set any magnification between 10% and 500%. The zoom factor remains set after you close the document, and is applied when you re-open the document until you specifically change the zoom.</p>
Toggle Page Border	<p>Switches between full-screen display and page outline display (the default) where the information is shown within the framework of a page border.</p>
Find Elements with Linked Documents	<p>Opens the Find in Project view preloaded with an executed search for elements that have Linked Documents; as you click on an item in the search results, the Document window shows the corresponding Linked Document.</p>
Find Elements with Linked Documents Modified Recently	<p>Opens the Find in Project view preloaded with an executed search for elements that have Linked Documents that have been updated within the last seven days (you can re-execute the search with a different number of days); as you click on an item in the search results, the Document window shows the corresponding Linked Document.</p>

Delete Linked Document	Deletes the Linked Document currently displayed in the window. A prompt displays for you to confirm the deletion.
Print	Displays the 'Print' dialog, which you use to configure the print job for printing the Linked Document.

Replace or Delete Linked Documents

If a Linked Document is out of date you can edit the text, or you can:

- Delete the content and replace it from another file, or
- Delete the document altogether

Access

Click on the element that contains the Linked Document.

Ribbon	<p>Start > Application > Design > Document or Explore > Portals > Windows > Properties > Document</p> <p>The Document Window opens, showing the Linked Document on the element.</p>
--------	--

Delete the Linked Document

Step	Action
1	Click on the  icon in the top left of the window, and select the 'Delete Linked Document' option at the end of the menu.

2	A prompt displays for you to confirm the deletion; click on the Yes button.
3	The Document window is cleared, and the  symbol on the element in any diagram is removed. You can now import or create content for another Linked Document on that element, select a different element, or close the Document window and/or move on to other work.

Create Linked Document Templates

To create a Linked Document, you can open an empty file and add the text and contents as you want. You can also base your Linked Document on a Linked Document template that you either:

- Select from a drop-down list of (initially) system-provided templates in the 'New Linked Document from Template' dialog or
- Create in the 'Linked Documents' folder of the 'Resources' tab of the Browser window

Linked Document templates that you create are added to the drop-down list on the 'New Linked Document from Template' dialog.

Access

Open the 'New Document Template' dialog using any of the methods outlined here.

When opened using one of these methods, the 'Template Type' field is set to 'Linked Document Template'.

Ribbon	Start > All Windows > Design > General > Browse > Resources > Linked Documents > right-click on a <template group> folder > Create Template Explore > Portals > Windows > Explore > Resources > Linked Documents >
--------	---

	right-click on a <template group> folder > Create Template
--	---

Create a template

On the 'New Document Template' dialog:

Step	Detail
1	In the 'New template' field, type a name for your template.
2	In the 'Copy template' field, if you want to base the new template on an existing template, click on the drop-down arrow and select the name of the source template. Otherwise leave the field set to 'None'.
3	Click on the OK button. The template opens in the Linked Document Template Editor in the Diagram View. Create and edit the template contents as you need.
4	Save the template (File > Save) and close the editor (✕ in the top right corner of the editor window). The template is immediately available for use.

- | | |
|---|---|
| 5 | <p>If you want to assign your template to another group, right-click on the template name in the 'Resources' tab of the Browser window and select the 'Move' option.</p> <p>The 'Enter the Linked Document Template Group name' dialog displays. In the 'Enter Value' field type a new or existing category name and click on the OK button.</p> <p>The template is immediately transferred to the named group.</p> |
|---|---|

Notes

- You can transport customized Linked Document templates between models, using the 'Settings > Model > Transfer > Export Reference Data' and 'Import Reference Data' ribbon options

Edit Linked Document Templates

To develop the contents of a Linked Document template, held in the 'Resources' tab of the Browser window, you use the Linked Document Template Editor. This opens the Document - Edit ribbon, which provides access to a wide range of convenient features for formatting and editing the template, and for adding links from and references to the content of the documents generated from the template. An in-text context menu also provides editing options for the template.

Access

Within the 'Resources' tab of the Browser window, click on 'Linked Documents > <template group> > Right-click on template name | Open'

Ribbon	Start > Application > Share > Resources Explore > Portals > Windows > Explore > Resources
--------	---

Option Descriptions

The Linked Document Template Editor option descriptions are grouped according to the actions you are performing.

Actions

Creating and importing template documents

Configuring the editor display

Incorporating stylesheets, special texts and Tables of Contents

Managing the base styles in the Normal.rtf style template file

Moving through, searching and selecting text

Formatting characters and text strings

Formatting paragraphs and text blocks

Inserting tab points

Inserting sections, columns and page breaks, and repaginating

Inserting and editing page headers and footers, and footnotes and endnotes

Inserting tables

Inserting hyperlinks

Checking spelling and use of terms

Tracking, accepting and rejecting changes to text

Protecting template text from accidental change

Inserting images, OLE objects, frames and drawing objects

Printer set up and printing documents

Notes

- Throughout your template editing:
 - To undo one or more immediately previous edits, press Ctrl+Z, or select the 'Undo' context menu option; you can still undo a change even after you have saved the change
 - To redo one or more immediately previous undone edits, press Ctrl+Y, or select the 'Redo' menu option

Hyperlink From Linked Document

Within the text of a Linked Document, you have several options for creating hyperlinks to other objects in the model, and to web pages, Help files, Model Searches and Model Library documents. You can also create links that generate RTF reports or diagram images, so that updates to the linked material can be quickly merged into the Linked Document as a Custom Report.

When you have saved the Linked Document, you can click on the hyperlink to open the linked files or to locate and highlight the object in the Browser window. You can perform all normal operations on the object, including opening any Linked Document that element might have. You can also, within the Linked Document, select a context menu option to update any linked-in reports and diagram images.

Using the Add Content to Document dialog

The 'Add Content to Document' dialog displays when you drag an object from the Browser window onto the Linked Document. This versatile dialog helps you add a number of features to your document, as explained in this table.

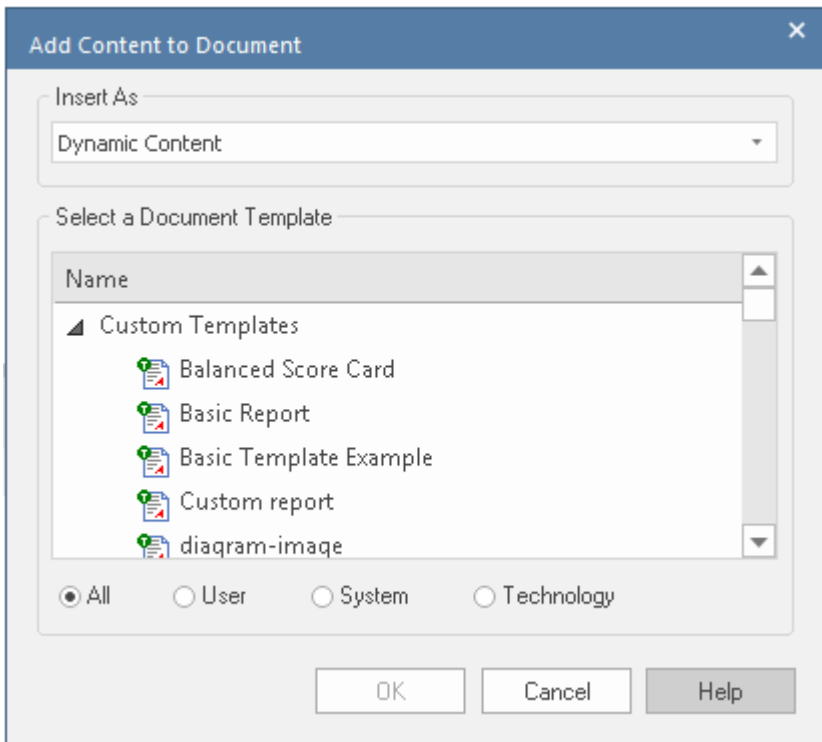

If you are creating a number of links of the same type, after you create the first link you can simply press the Ctrl key as you drag the next object onto the document without displaying the dialog. The system creates further links of the same type, until you display the dialog again and change the 'Insert as' option.

Task	Action
<p>Create Hyperlinks to Model Objects</p>	<p>In the Browser window, click on the object (of any type, including a diagram or Package) and drag the object into the Linked Document to the position at which to create the hyperlink.</p> <p>On the 'Add Content to Document' dialog (if necessary) click on the 'Insert as' drop-down arrow and select 'Insert as Hyperlink(s)'.</p>

	<p>Click on the OK button. The system creates the hyperlink, using the object name as the hyperlink text. You can edit this text if you prefer.</p>
<p>Insert an RTF Report on a Model Object</p>	<p>In the Browser window, click on the required element, diagram or Package and drag the object into the Linked Document to the position at which to insert the report text.</p> <p>On the 'Add Content to Document' dialog, click on the 'Insert as' drop-down arrow and select 'Render as RTF'.</p> <p>Click on the appropriate radio button ('All', 'User', 'System' or 'Technology') to display the selection of RTF templates you want to choose from, and click on the required template.</p> <p>Click on the OK button. The system generates the RTF report according to the template, and inserts it at the cursor location.</p> <p>At any later point, you or another user can refresh the RTF reports in the Linked Document by right-clicking in the document and selecting the 'Update Dynamic Report elements' menu option. Note that this option will reinstate any text you might have deleted from the</p>

	inserted reports.
Insert a Diagram Image	<p>In the Browser window, click on the required diagram and drag the diagram into the Linked Document to the position at which to insert the diagram image.</p> <p>On the 'Add Content to Document' dialog, click on the 'Insert as' drop-down arrow and select 'Insert as Diagram Image'.</p> <p>Click on the OK button. The system generates the diagram image and inserts it at the cursor location.</p> <p>At any later point, you or another user can refresh the image in the Linked Document by right-clicking in the document and selecting the 'Update Dynamic Report elements' menu option.</p>

Using the Linked Document Context Menu

You can also create hyperlinks to model objects within a Linked Document using the Linked Document Editor context menu. You first select a text string in the document to act as the link text and, in the case of a new object, to act as the name of the element.

Option	Action
--------	--------

<p>Link to an Existing Element</p>	<p>Highlight the link text in the Linked Document, right-click on it and select the 'Create Link to Existing Element' option. The 'Select Element' dialog displays, through which you browse or search for and select the element to link to.</p>
<p>Link to a New Element or Diagram</p>	<p>Highlight the link text in the Linked Document, right-click on it and select the 'Create New' option. A short submenu displays from which to select a specific type of element to create, or a diagram. When you click on an element type, a new element of that type is created.</p> <p>If you select the 'Create New Diagram' option, the 'New Diagram' dialog displays and you can select the type of diagram to create.</p> <p>If the element type you require is not presented in the short list, click on the 'Other' option to display the 'New Element' dialog, from which you can select the toolset containing the element type to create, and the element type itself. In each case, the new element or diagram is added to the Package that contains the parent element of this Linked Document. The link text becomes the name of the</p>

	<p>new object, and in the Linked Document is the hyperlink to that new object.</p>
<p>Link to an Object or Document in the Model</p>	<p>Highlight an appropriate text string to act as the link text, right-click on it and select the 'Create Hyperlink' context menu option.</p> <p>The 'Hyperlink Details' dialog displays, through which you specify the type of document or object to link to. Depending on what object or document type you select in the 'Type' field, a small dialog displays to help you locate and select the target. For the location, you can use either full paths or local (path substitution) paths.</p> <p>In some cases you might not want to have normal text as the hyperlink, but the text of the link itself. In this case, do not highlight any text or, in the 'Hyperlink Details' dialog, type any link text in. The system then inserts the address path or the provided text as the link text.</p>

Using the Ribbon Option

You can also insert a Hyperlink in your document to link to a web page, Help topic or external file.

Click on the point in the document to insert the hyperlink and select the 'Document-Edit > Edit > Insert Hyperlink' ribbon option.

The simple 'Insert Hyperlink' dialog displays, in which you specify the type of document to link to, and the location of the document file. See the *Insert Hyperlinks* Help topic.

Create Element From Document

Whilst you can set up hyperlinks from the Linked Document to existing elements and diagrams in the Browser window, you can also create new elements to illustrate and support information written in the Linked Document. You can create and link to any type of element or diagram, but the facility has specific options for these element types:

- Class
- Requirement
- Issue

The element or diagram is created in the same Package as the element for which the Linked Document was created. A hyperlink is automatically created in the document to the new object. When you click on the hyperlink, the element or diagram is highlighted in the Browser window.

Create element or diagram

Step	Action
1	Open the Linked Document in the model element or Document Artifact element.
2	Enter or select the appropriate text to act as the hyperlink text (such as the element or diagram

	<p>name).</p> <p>Highlight this text and select the Document - Edit > File > Model Link > New Model Element > <element type> ribbon option.</p>
3	<p>If you select the:</p> <ul style="list-style-type: none">• 'Class', 'Requirement' or 'Issue' option, the corresponding element is immediately created in the Browser window• 'Other' option, the 'New Element' dialog displays; specify the element type and - if appropriate - stereotype, and click on the Create button• 'Diagram' option, the 'New Diagram' dialog displays; specify the diagram type and click on the OK button
4	<p>The highlighted text is now a hyperlink to the new object in the Browser window. Click on the link to highlight the object.</p> <p>You can now edit or expand the element or diagram as required.</p>

Connectors

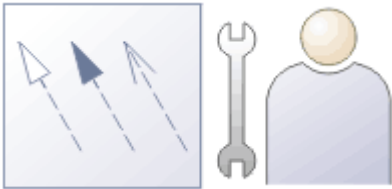

Relationships in any context can be hard to understand, and relationships between model elements are no exception. In modeling, the elements are only part of the model; relationships are like a glue that binds the elements together or, making a comparison with natural languages, if the elements are nouns the relationships are verbs that describe how the nouns relate to each other.

Relationships are represented in modeling diagrams by different types of line, or connector, each line indicating the kind of relationship and interaction there is between the elements. The connector types are defined by the modeling languages or profiles they belong to. For example, Associations and Generalizations are part of the grammar of UML; Sequence Flows and Message Flows are part of the grammar of BPMN; and Allocates and Item Flows are part of the grammar of SysML. Each connector type has a notation that helps modelers recognize the connector and understand its purpose; the types also inform tools such as the Code Templates Framework how to generate resulting models, schemas or programming code.

There are many different types and styles of connectors. They can have arrows (indicating direction) or other markers that express the semantics of the relationship; they

can have names, stereotypes and Tagged Values, and a wide range of other properties. Some connectors are like conduits that allow material and tokens to flow; some are about family, others tell an element to change its state, while still more are about signals and structure. It is important to remember that a diagram is just a projection (or view) of an underlying model and just because a connector isn't visible on the diagram it doesn't mean that it doesn't exist. Perhaps the best way to think about a diagram is as a narrative or story that is trying to reveal a plot to an audience. The connectors play an important role in this story telling, and hiding them or leaving them out is sometimes as important as putting them in.

Connectors can also 'reach' inside the perimeter of the element and be attached to an element's features (attributes, operations and receptions). This is particularly useful when doing data matching, for example, between two different data sources.

There are a number of places where you can review connectors in Enterprise Architect - other than in diagrams - including the Traceability window, the simple Feature and Gap matrixes, the Relationships Window, the Hierarchy Window, the Relationship Matrix, the 'Details' tab of the Inspector window and the 'Properties' dialog for an element. They are, however, most expressive in diagrams, where their characteristics and properties are easily observable.

Factors in Modeling Connectors

Operation	Discussion
Routing and Bending	<p>Connector lines require geometry to be able to navigate around the elements on the diagram as they emerge from one element and connect to another.</p> <p>Thoughtful placement of related elements can limit the need to route connectors, but it is often the case that connectors have to be bent and directed. Some line styles - such as the Auto Routing style - can manage this automatically, but using the Custom Style is the most flexible method, allowing any number of way-points to be added to a connector, at each of which the line can be bent to direct it in a complex path through the diagram. The Diagram Layout tool also provides ways of automatically laying out a diagram to organize it neatly with a minimum of crossed lines. When lines do have to cross you can select an option to add jump symbols to reduce the ambiguity of the line direction.</p>
Changing Style	<p>Connectors have default line styles that you can change to create more appealing and meaningful representations of the relationships; for example, a relationship</p>

	<p>of family can be represented by a Tree style. This shows the parent element at the top and the child elements in a row underneath (or in a column to the side) with the connectors between each child and the parent having a common 'trunk' at the parent, in a tree format. The same relationships could also be viewed as a collected set in an Orthogonal or Lateral style. All connectors of a similar type can be conveniently changed to the same type on a diagram. Other line styles, such as Auto Routing, will themselves change the bends in a connector as an attached element is moved in the diagram. The Custom style is the most flexible, allowing you to bend the connector at any point to create any number of way points and route the connector around the diagram layout.</p>
<p>Using Color and Line Thickness</p>	<p>The color and thickness of lines can be changed to create meaning and appeal in diagrams. These changes are local to the selected connector(s) on any diagram, but using the style picker and painter of - for example - the Layout ribbon you can apply the selected line style to multiple connectors. While the tool offers great flexibility to assign styles manually, it is</p>

	<p>worth considering the use of Diagram Legends, which can automatically change the style of the connectors (and also elements) based on connector metadata such as the connector's stereotype.</p> <p>Connector labels can also be changed at a granular level. Each label reflects a property of the connector, although you can also edit the text in a label. You can hide or show the labels, change their text color and bold them, add direction arrows, display the text horizontally or vertically, and return the moved label to its original position.</p>
<p>Connector Direction and Ends</p>	<p>In our natural languages verbs have direction; for example 'The cat likes Juliet.' is not the same as 'Juliet likes the cat.' So too with connectors, direction often reveals important semantics, and the ends of the connector can be labeled with a variety of markers that express the details of the meaning. It easy to make mistakes when creating diagrams, and to draw the connectors in the wrong direction. Fortunately there are some useful features for working with connector direction, including being able to reverse the direction of a connector without the need to recreate it. Connector</p>

	<p>ends can also be pinned so that the connector stays bound to its attachment point on the connected element.</p>
<p>Showing and Hiding Connectors</p>	<p>As mentioned earlier, a diagram is a narrative and the choice to include, show, hide or remove connectors is an important decision in telling the right story. When elements are placed on a diagram Enterprise Architect will, by default, add the existing connectors (remembering that elements can have reflexive connectors). A modeler can choose a variety of options to either completely hide specific connectors in this diagram and/or other diagrams, hide all the labels, or selectively hide parts of the labels such as role names and multiplicities. Hiding parts of the labels can be a useful option when presenting to non-technical audiences, who tend to be distracted by all the detail. Connectors that have been hidden can easily be made visible again from the 'Diagram' panel of the 'Layout' ribbon. You can also 'freeze' a diagram so that it shows all the connectors you require at that point, but will not update with any other connectors subsequently created between the elements.</p>

Types and Markers

Enterprise Architect is a standards-based tool, and many of the diagrams and their constituent elements and connectors are intentionally defined as part of a standard. Thus a Business Process diagram will contain Activities and Tasks sequenced with Control Flow connectors, and a Domain diagram will have Associations to express structural relationships such as whole-part. The modeler is thus aided and at the same time straight-jacketed by what the chosen modeling language defines as the allowable connectors. We of course face the same thing in our natural languages, where we must choose the right form of a verb or the meaning of the sentence will be lost. So in English 'Jonathon went fishing with Wendy' is a good sentence, but 'Jonathon went Wendy with fishing' is not. So too with the connectors, which have markers, labels and annotations that must be used to express meaning in the models. For example, a Composite Association in the Unified Modeling Language has a solid black marker at the whole end of the relationship with an important multiplicity label at the other. If you reverse the direction, the meaning

	of the 'sentence' will be changed.
--	------------------------------------

Connector Management Options

If you right-click on a connector in a diagram, one of two connector context menus can display. These provide quick access to some important functions.

Menus

Menu	Description
Context Menu	<p>The menu is split into up to seven distinct sections:</p> <ul style="list-style-type: none">• Specialize - displays in the first section only if you have Add-Ins installed and registered• Properties, including Advanced features• Type Specific• Style and Appearance• Position• Type Information - Displays the Enterprise Architect Help topic for this connector type• Delete - deletes the connector
Connector Role Context	<p>For connectors with Roles, right-clicking a connector within 60 pixels of an end</p>

Menu	<p>point displays a role-specific context menu that offers three additional menu options:</p> <ul style="list-style-type: none">• 'Source/Target Role...' - opens the connector 'Properties' dialog with the respective role page selected• 'Multiplicity' - opens a submenu through which you can set the multiplicity for the role• 'Link to Element Feature' - displays a dialog through which you can attach the end of the connector to a specific attribute or operation
------	--

Notes

- Context menus vary slightly between connector types, and not all menu options are present on all connector context menus; the type-specific menu options are not always included

Connector Type-Specific Options

The 'Type-Specific' section of the connector context menu is specific to the object, and only appears for a few different connectors. Some examples are described here.

Connector Options

Connector	Menu Option
Transition	<p>Locate in State Table</p> <p>Action: Switch a StateMachine diagram to a State Table, with the selected Transition cell highlighted on the table.</p>
Transition	<p>Message</p> <p>Action: Set the value of the Message.</p>
Transition	<p>Find Triggers Associated</p> <p>Action: Identify hidden triggers, and locate a trigger in the Browser window; if there:</p> <ul style="list-style-type: none"> • Is one trigger, it is immediately highlighted in the Browser window • Are two or more triggers the 'Element Usage' dialog displays, listing the triggers; double-click on the required

	<p>trigger to highlight it in the Browser window</p>
Transition	<p>Queue Triggers in Simulation Action: (Available when a simulation is being executed.) Adds the Trigger to the end of the list in the 'Simulation Events' tab of the Breakpoints & Events window, without signalling it.</p>
Transition	<p>Signal Triggers in Simulation Action: (Available when a simulation is being executed.) Adds the Trigger to the 'Simulation Events' tab of the Breakpoints & Events window and signals it at the current step of the simulation, leaving it with the status signaled.</p>
Association	<p>Find Association Class Action: Locate and highlight the Association Class element in the Browser window.</p>
Aggregation	<p>Set Aggregation to Composite Action: Change the Aggregation to Composite.</p>

Aggregation	<p>Set Aggregation to Shared</p> <p>Action: Set the Aggregation to shared; this appears after 'Set Aggregation to Composite' has been selected.</p>
InformationFlow	<p>Find Items Conveyed</p> <p>Action: (Listed only if there are Information Items on the connector.)</p> <p>Locate the Information Item in the Browser window; if there:</p> <ul style="list-style-type: none">• Is one item, it is immediately highlighted in the Browser window• Are two or more items the 'Element Usage' dialog displays, listing the items; double-click on the required item to highlight it in the Browser window

Notes

- Context menus vary slightly between connector types, and not all menu options are present on all connector context menus; the type-specific menu options are not always included

Manage Connector Properties

The 'Properties' section of the connector context menu provides a small set of options.

Menu options

Option	Action
<Connector type> Properties	Open the Properties window for the selected connector.
Advanced	Display the Advanced menu.
Attach Note or Constraint	Attach a note or constraint to the connector.

Notes

- Context menus vary slightly between connector types, and not all menu options are present on all connector context menus; the type-specific menu options are not always included

Advanced Connector Management Options

The 'Advanced' section of the connector context menu provides a number of options.

Menu Options

Option	Action
Change Type	Change the connector type.
Change Direction	Keep the ends of the connector the same but change the direction setting. There are four options: <ul style="list-style-type: none">• Unspecified• Source -> Destination• Destination -> Source• Bi-Directional
Reverse Direction	Reverse the ends of the connector; for example, if the connector is an arrow, the arrowhead swaps to the other end. This command maintains the direction of the connector (such as Source -> Destination).

Set Source and Target	Change the source and/or target of the connector.
Specialize Associations	Specify how the properties of this Association specialize the properties of other Associations.
Information Items Conveyed	Add information items to an Information Flow connector.
Information Flows Realized	Realize any information items conveyed on an Information Flow connector between two elements.
Generalization Set	Click on the 'New' option to create a Generalization Set, which enables you to specify the relationship of a group of Generalizations. Each Generalization is a binary relationship that relates a specific Classifier to a more general Classifier (for example, from a Class to its Superclasses). Each Generalization Set defines a particular set of Generalization relationships that describe the way in which a general Classifier (or superclass) can be divided using specific subtypes.
Dependency	Select a stereotype for the Dependency

Stereotypes	(or Trace, Role Binding, Occurrence or Represents connector).
Extension Points	On an Extend connector between two Use Cases, provides options to: <ul style="list-style-type: none">• Specify which Extension Point (if any) in the target Use Case the connector and its source Use Case relate to• Show or hide the Note element that identifies the defined Extension Point

Notes

- Context menus vary slightly between connector types, and not all menu options are present on all connector context menus; the type-specific menu options are not always included

Connector Style Options

The 'Style' section of the connector context menu provides a number of options.

Style Options

Option	Action
Line Style	Set the connector line style; the options are: <ul style="list-style-type: none"> • Direct • Auto Routing • Custom Line • Bezier (not on all diagram types) • Tree Style Horizontal or Tree Style Vertical • Lateral Horizontal or Lateral Vertical • Orthogonal (with Square or Rounded corners)
Apply Line Style on Diagram	Apply the line style of the selected connector to all other connectors on the diagram of the same: <ul style="list-style-type: none"> • Type • Subtype (including Type) or • Stereotype (including Type and

Subtype)

This helps you apply a style change to one connector to many other connectors on the diagram, in one go.

On this section of a diagram there are six connectors.

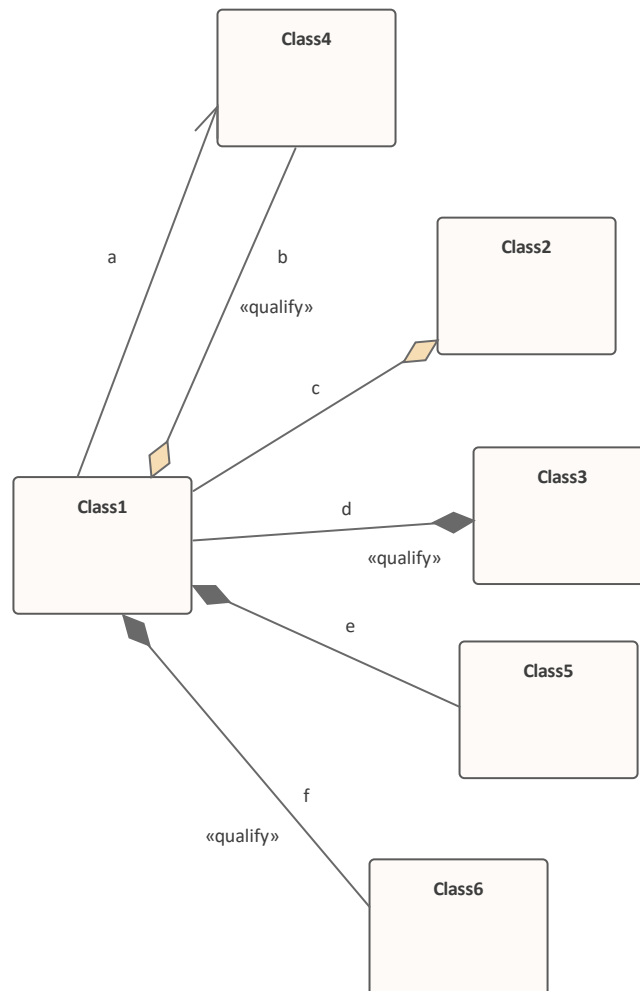

- All connectors except **a** are Aggregation connectors (**a** is an Association)
- Connectors **b** and **c** are the subtype 'weak' Aggregations; connectors **d**, **e** and **f** are 'strong' Aggregations

- All connectors are Direct line style
- Connectors **b**, **d** and **f** have the stereotype <<qualify>>

Suppose you change connector **d** to the line style Orthogonal Rounded.

If you right-click on connector **d** and select the 'Apply Line Style on Diagram | Connectors of the same Type' option, you should see these changes to the connectors (all connectors, being Aggregations, are now Orthogonal Rounded style except for **a**, which is not the same *type* as the others):

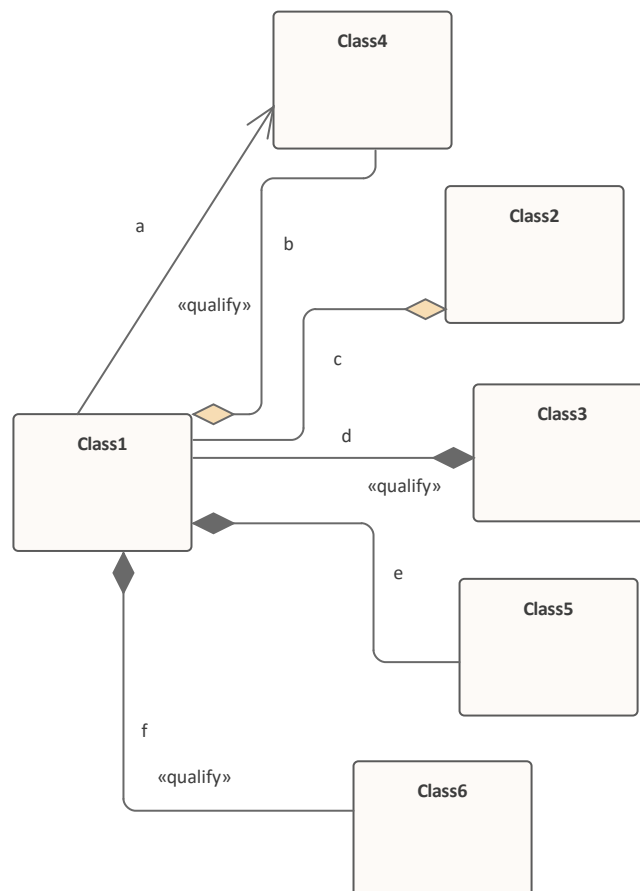

OR, if you right-click on connector **d** and

select the 'Apply Line Style on Diagram | Connectors of the same SubType' option, you should see these changes to the connectors (only connectors **e** and **f** change because only those two are the same *type* and *subtype* as **d**, being strong Aggregations):

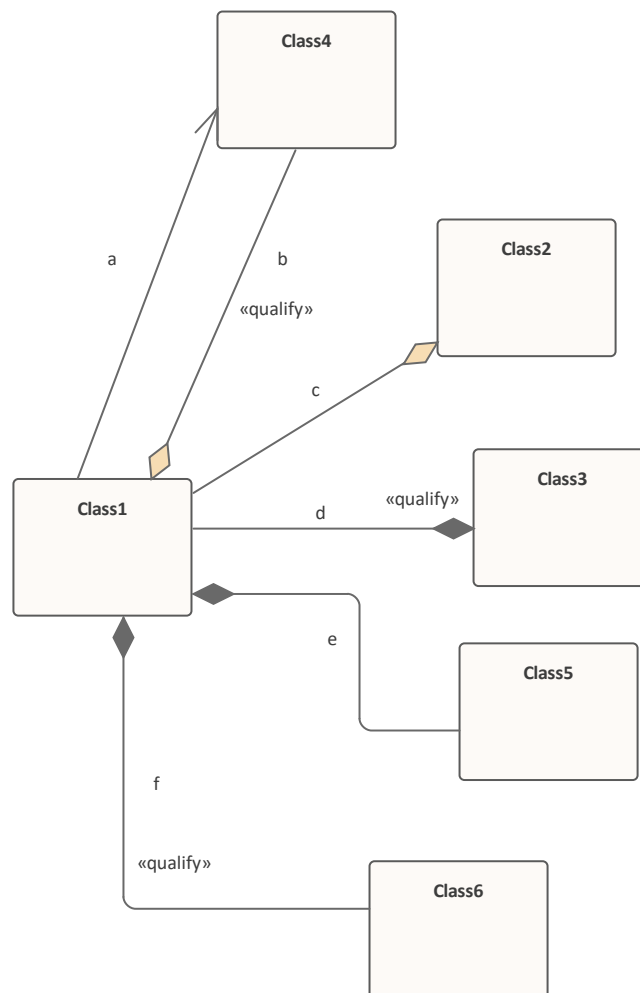

OR, if you right-click on Connector **d** and select the 'Apply Line Style on Diagram | Connectors of the same Stereotype' option, you should see these changes to the connectors (connector **f** changes because it has the same *type*, *subtype* and

stereotype as **d**; connector **b** is unaffected because it is not the same subtype, and **e** is unaffected because it is not the same stereotype):

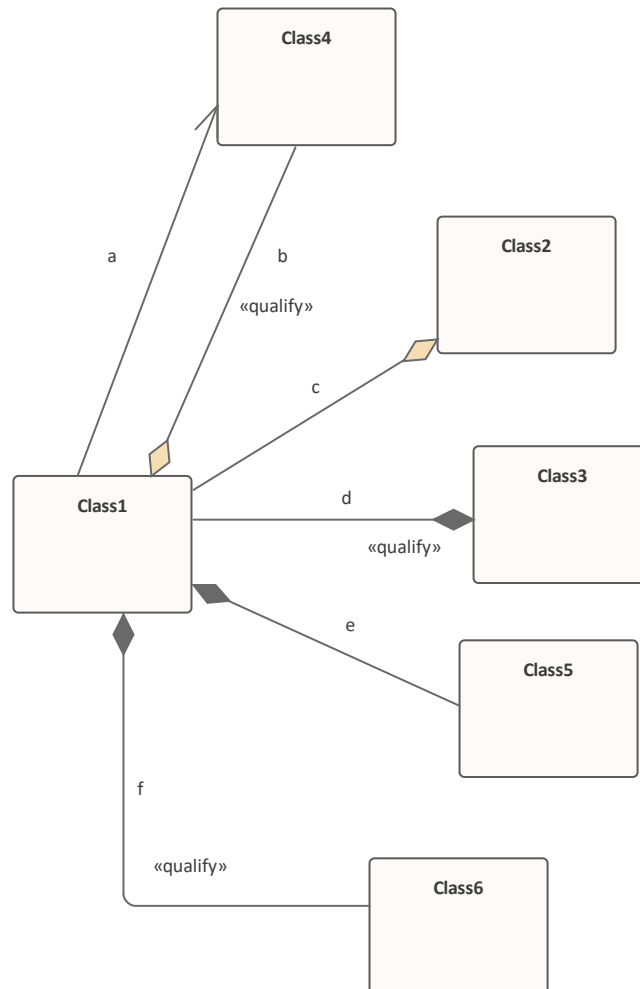

Note that the 'Connectors of the same Subtype' option is of value for the small group of connector types that support subtypes, such as Aggregations (Shared or 'weak' and Composite or 'strong') and Dependencies (Trace, Abstraction).

The option only applies if the subtype is set from the context menu as part of the process of creating the connector. If the

	<p>subtype was derived from the nature of the source element, target element and/or base connector, the option does not function.</p>
Pin End(s)	<p>Pin the connector start and/or end to the current position on the target element; a sub-menu displays to offer the options of pinning the start point only, the end point only, or both.</p> <p>Once one or both ends are pinned, a fourth option is available to UNPIN both ends.</p> <p>Some connector line styles (such as the Tree styles) are not compatible with pinning the connector ends; if a pinned connector is changed to one of these styles, the connector ends will be unpinned.</p>
Bend Line at Cursor	<p>Insert an anchor point on the line at the point of the cursor so you can change the shape of the line.</p> <p>Shortcut: Ctrl+Q</p>
Suppress Line Segment	<p>Hide a segment of a connector so that you can view a part of the diagram that it crosses.</p> <p>To reverse the change, right-click on the</p>

	connector and select the 'Show All Line Segments' option.
Straighten Line at Cursor	Remove an anchor point on the line at the point of the cursor. (This is the exact opposite of 'Bend Line at Cursor', and Ctrl+Q toggles the connector point between the options). Shortcut: Ctrl+Q

Notes

- Context menus vary slightly between connector types, and not all menu options are present on all connector context menus; the type-specific menu options are not always included
- If two connectors cross, the later connector has a 'hoop' at the intersection, indicating that the connectors are crossing

Connector Appearance Options

The 'Appearance' section of the connector context menu provides a number of options.

Appearance Options

Option	Action
Appearance	<p>Set the line color and line thickness of the connector.</p> <p>Select one or more relationships, then right-click and select 'Appearance'.</p> <p>On the 'Connector Appearance' dialog, click on the drop-down arrow in the:</p> <ul style="list-style-type: none">• 'Line Color' field, and select the color to apply to the connector lines• 'Line Thickness' field, and select the line thickness of the connector lines <p>Click on the OK button to apply the settings to all the selected connectors on the element.</p> <p>For the selected connectors, you can also right-click and select 'Line Style', and one of the listed styles. The style is immediately applied to the connectors on the diagram.</p>

Visibility	Set connector visibility; see the <i>Visibility Sub-Menu</i> table for sub-menu options.
Tidy Line Angles	Tidy the line angles of a custom connector.

Visibility Sub-Menu

Option	Action
Hide Connector	Hide the connector. To show the connector again, see the <i>Hide/Show Connectors</i> Help topic.
Hide Connector in Other Diagrams	Hide or show the connector in other diagrams.
Hide All Labels	Hide or show all labels attached to the connector.
Set Label Visibility	Hide or show labels attached to the connector, individually.

Notes

- Context menus vary slightly between connector types, and not all menu options are present on all connector context menus; the type-specific menu options are not always included

Connector Tasks

This topic identifies the commoner tasks associated with managing model connectors, including:

- [Connect Elements](#)
- [Connect to Element Feature](#)
- [Connect to a Connector](#)
- [Connector Styles](#)
- [Arrange Connectors](#)
- [Change Connector Type](#)
- [Create Connector in Browser Window](#)
- [Reverse Connector](#)
- [Delete Connectors](#)
- [Freeze Visible Connectors](#)
- [Hide/Show Connectors](#)
- [Creating Generalization Sets](#)
- [Change the Source or Target Element](#)
- [Relationship Visibility](#)
- [Add a Note to a Connector](#)
- [Tree Style Hierarchy](#)
- [Show Uses Arrow Head](#)
- [Set Association Specializations](#)
- [Change Sequence Message Scope](#)

Notes

- In the Corporate, Unified and Ultimate Editions, if security is enabled, you must have 'Update Element' permission to update or delete a connector

Connect Elements

This topic explains how to connect elements using the appropriate connector types on a diagram.

Actions

Action	Detail
Connect Elements on a Diagram	<p>The fastest and simplest ways to create connectors are using the Quick Linker and using the Toolbox.</p> <p>To create another connector of the same type as the last connector you used, click on the appropriate source element and press F3.</p>
Selecting Connectors	<p>To select a connector, simply click on it; drag handles display, indicating that the connector is selected.</p> <p>This gives the connector focus for keyboard commands such as 'Delete', and displays connector properties in docked windows such as the Properties window.</p> <p>If there is more than one connector on a diagram, you can cycle through them using the arrow keys.</p>

<p>Drag Connectors</p>	<p>You can drag a connector to position it; click on the connector and drag it to where it is to appear - note that there are some limitations on how far or to where you can drag a connector.</p> <p>You can also reattach the end of a connector to a different source or target element.</p>
<p>Connector Properties and Commands</p>	<p>You can double-click on a connector to change properties in the 'Properties' dialog, or press Ctrl+2 and click on the connector to access the properties in the Properties window.</p> <p>You can also right-click on a connector to display the context menu containing commands to change connector type and direction.</p>
<p>Highlighting Connectors</p>	<p>You can highlight the connectors on a specific element by selecting the element and then pressing and holding the L key - all the connectors issuing from or terminating at that element are highlighted in separate colors. This is a useful feature to apply in conjunction with the context filtering facility on an element on a diagram.</p>

Create Connectors Without a Diagram	Sometimes it is useful to create relationships between elements without a diagrammatic representation; you can do this using the Browser window and the Relationship Matrix.
-------------------------------------	--

Notes

- You can reposition a connector by selecting and dragging the connectors as required
- If a connector has source and target roles, you can attach either end of the connector to a specific attribute or operation in the source or target element
- If required, you can also create a connector between another connector and an element, or between two connectors

Connect to Element Feature

If a connector has source and target roles, you can connect either end of the connector to a specific operation or attribute in the source or target element. This is entirely a visual aid, to indicate which features are significant in the relationship. In code generation or transformation, the link is interpreted as a normal source-element to target-element relationship.

Enterprise Architect provides an alternative method of connecting element features, similar to the Quick Linker facility. See the *Feature Quick Linker* Help topic. In that facility, the connector does not have to exist first - you can create the connector as part of the process.

Connect the end of the connector to a specific operation or attribute

Step	Action
1	Right-click on the end of the connector joined to the element containing the required feature.
2	Select the 'Link to Element Feature' context menu option. The 'Link to Element Feature' dialog displays.

3 In the 'Feature Type' field, click on the drop-down arrow and select the required feature type - 'Attribute' or 'Operation'.
The attributes or operations from the element are listed in the 'Feature' field.

4 Click on the required attribute, operation or maintenance item, and click on the OK button.
The end of the connector changes to a bracket next to the selected feature.

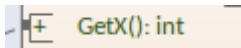

You might create a number of feature-to-feature relationships between two elements (such as a Class and a Table that represents the Class data) to produce a diagram similar to this:

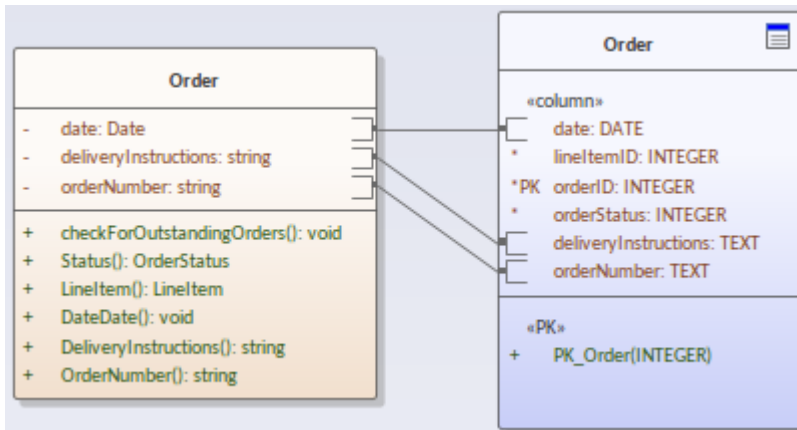

You can change the feature to which the connector is attached by following the procedure and selecting the new feature.

You can break the link to the selected feature in any of these ways:

- Work through the procedure, setting the 'Feature

Type' to 'None'

- Delete the attribute or operation from the element
- Change the connector type to a type that does not have source and target roles
- Change the connector to a different source or target element that does not contain the feature

Note that reversing the direction of the connector does not break the connector's attachment to the feature.

Notes

- The 'Link to Element Feature' option is not supported for reflexive/self connectors
- If you have created, or intend to create, multiple relationships between the features of two elements, you can manage those relationships using the Feature Matrix

Feature Quick Linker

When developing a model structure on a diagram, you can either create connectors by clicking on a Toolbox icon and dragging the cursor between two elements, or by using the Quick Linker arrow to generate both a connector of an appropriate type and a target element.

If a connector is to have source and target roles, you can connect one or both of the ends of the connector to an operation, attribute or Reception in the source or target element to indicate which specific features are significant in the relationship. You can create the connector first and then configure it (as described in the *Connect to Element Feature* Help topic) or you can use a facility similar to the Quick Linker to generate an appropriate connector between the source element or feature and the target element or feature.

Prerequisites

In order to display and use the Feature Quick Linker, you must first:

- Create or open the diagram in which to generate the feature connectors
- Create the appropriate elements and features
- Display the Properties window for the diagram, expand the 'Connectors' segment and select the 'Show Feature Linker' checkbox

Connect Features

In the appropriate element on the diagram, click on and highlight the required source feature. The Feature Quick Linker icon displays against that feature.



Click on the icon and drag the cursor across to either the element to link the feature to, or the feature within the element for a feature-to-feature link. When you release the left mouse button, a short menu displays listing the types of relationship that are appropriate for the link. Click on the required relationship type.

The diagram now shows the connector between the two elements, with the end or ends that specify a feature having a square bracket and anchor point, as illustrated here:

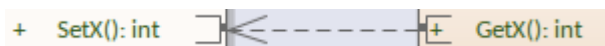

If appropriate, you can continue to create relationships between features of the same pair of elements or those elements and other elements.

The Feature Matrix

If you have created - or if you intend to create - a number of relationships between a pair of elements and their features, you can create and/or manage those relationships using the Feature Matrix. This is very similar to the main Relationship Matrix in Enterprise Architect, except that it is focused on two selected elements and shows the relationships for which the source and/or target is an element attribute, operation or reception.

Prerequisites

In order to use this facility, you select two elements on an open diagram in Graphical view

At least one of the elements in the pair that you select must have attributes, operations and/or Receptions (for relationships between an element and another element's features).

You cannot use this facility for more than two elements at a time; if you select more elements, only the first two selected are shown in the Matrix

Access

On the diagram, select (for example, Ctrl+click) the two elements and select the Feature Matrix using one of the methods in this table.

Ribbon	Design > Element > Feature/Matrix
Context menu	Right-click on one of the selected elements and select the 'Show Elements Matrix' context menu option

Adjust Display

On the Feature Matrix, the 'Source' and 'Target' fields default to the names of the selected elements. You cannot change these two fields. However, you can modify which aspects of the relationship information are shown in the Matrix, by changing the settings on other fields.

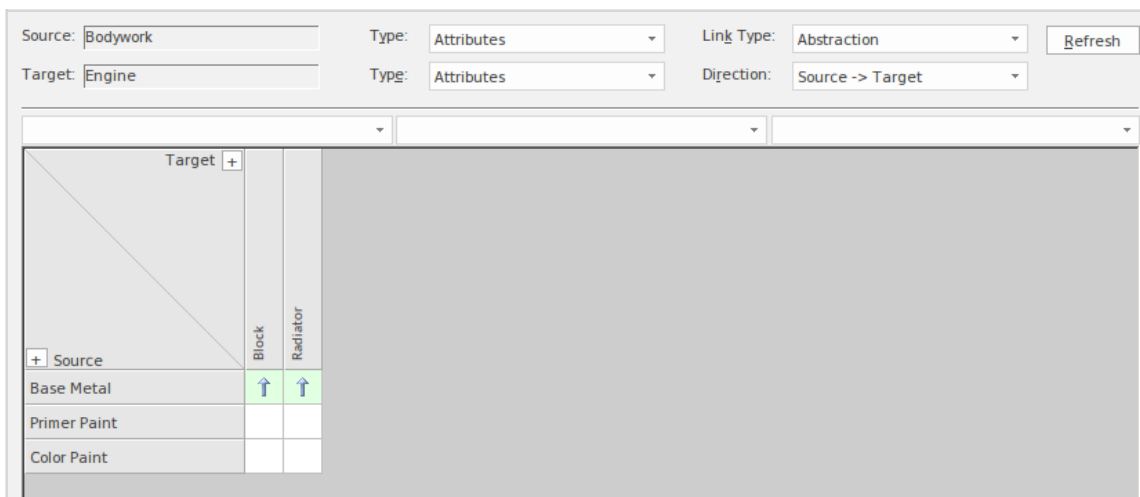

Field/Option	Description
Type	These two fields identify the type of feature to display relationships for, in the Source and Target elements. In the

	<p>illustration both fields are set to 'Attribute', so the matrix shows relationships between the attributes of the two elements.</p> <p>To include or switch to the required type of feature, click on the drop-down arrow and click on '<All>', 'Attributes', 'Operations' or 'Receptions'.</p>
Link Type	<p>The 'Link Type' field indicates what kind of relationship is shown in the Matrix. To select the type of relationship to show, click on the drop-down arrow and click on the type. You can display relationships of all types (with the default <All> option) or a specific type - in the illustration, this is 'Abstraction'.</p>
Direction	<p>This field indicates the direction of the relationships shown on the Matrix. In the illustration, the field is set to 'Source -> Target' and the matrix cells indicating a relationship show arrows pointing to the target feature. If you want to change the setting to show relationships created from the target to the source, or relationships that are in any direction, click on the drop-down arrow and select the 'Target -> Source' or 'Both' value. The relationship</p>

	indicator arrows pointed towards the source and in both directions, respectively.
Refresh	If you have changed the diagram whilst displaying the matrix, click on this button to ensure that the changes are reflected in the matrix, where appropriate.
Options	Click on this button to display a short menu of options to capture the matrix settings as a profile, capture the matrix data as a file to export, or refine the information displayed in the matrix. See the <i>Matrix Options</i> table.

Create a New Relationship

Step	Action
1	<p>In the 'Link Type' field, select the type of relationship you want to create, and in the 'Direction' field select the direction of the relationship(s) to create.</p> <p>You can also refine the display to show only features of a specific type between which to create</p>

	<p>relationships, by setting the source and target types in the 'Types' fields.</p>
2	<p>Right-click on the empty square at the intersection of the appropriate source row and target column. You can select and operate on several squares (creating several relationships) at once. Either:</p> <ul style="list-style-type: none">• Press Ctrl as you click on each intersecting square, then right-click on one of the selected squares, or• Click on the first square in the required row, column or block, then press Shift as you click on the final square in the required row, column or block; right-click on one of the selected squares <p>Note that if you click on a cell representing an existing connector, you can go through these steps to replace that connector with a different connector.</p>
3	<p>Select the 'Create new relationship' option. If the 'Link Type' field is set to '<All>', the option is 'Create <direction>' and a further submenu displays listing the type of relationship you can create; in this case, click on the required type of relationship. If, in addition, the 'Direction' field is set to 'Both', you have two options:</p> <ul style="list-style-type: none">• 'Create Source To Target' and• 'Create Target to Source' <p>Each option again displays a submenu of connector types.</p>

4	A connector of the selected type is created between the two elements, and the appropriate indicator displays in the matrix cell.
---	--

Manage Relationships

If you right-click on a cell representing an existing connector, two additional options display:

- 'View Relationship' - which displays the 'Properties' dialog for the connector, and
- 'Delete Relationship', which prompts you to confirm the deletion; if you click on the Yes button the relationship is immediately removed from the model (not available if the 'Direction' field is set to 'Both')

Matrix Options

Click on the Options button to display the menu providing the options in this table.

Option	Description
Matrix Scale Setting	<p>When you print the Feature Matrix, by default it prints on as many pages wide and long as the Matrix requires.</p> <p>You can scale the printout into a fixed number of pages wide; the row height is</p>

	<p>automatically adjusted to maintain the proportions of the Matrix. This reduces the overall size of the printout and improves appearance, especially when used in conjunction with the 'Landscape' option in the printer properties. For example, a 16-page printout without scaling can, with a scaling of 2 pages wide, be reduced to 6 pages.</p> <p>To set the page scaling:</p> <ol style="list-style-type: none"> 1. Click on the 'Matrix Scale Setting' option. The 'Scale Matrix' dialog displays. 2. Select the 'Scale Matrix Width into Pages' checkbox, and type or select the number of pages in width to scale to. 3. Click on the OK button to apply the setting.
<p>Matrix Print</p>	<p>Select this option to display the 'Print' dialog, on which you select the output printer and specify the printer properties, the range of pages to print, and the number of copies.</p> <p>The output is a WYSIWYG representation of the Feature Matrix contents.</p>
<p>Matrix </p>	<p>Select this option to save the matrix</p>

<p>Save as Metafile</p>	<p>contents as a .emf graphics file. A browser dialog displays on which you select the target file location and specify the filename in which to save the output. You can incorporate this file in a document or web report, as either a hyperlinked file or an included file.</p>
<p>Matrix Save as PNG</p>	<p>Select this option to save the matrix contents as a .png graphics file. A browser dialog displays on which you select the target file location and specify the filename in which to save the output. You can incorporate this file in a document or web report, as either a hyperlinked file or an included file.</p>
<p>Matrix Export to CSV</p>	<p>Select this option to export the contents of the Feature Matrix to a CSV file, which is a convenient mechanism for moving the matrix data to a spreadsheet environment such as Microsoft Excel. The Windows 'Browser' dialog displays; browse to the required file location and type in a .csv filename to export to, then click on the Save button to export the data.</p>
<p>Profiles </p>	<p>If you use a particular combination of</p>

<p>Save as New Profile</p>	<p>field values often, you can save that combination as a profile to make it easier to recall it for use.</p> <p>Select this option to save the current field settings as a new profile in a Feature Mapping Artifact. A dialog displays to prompt you for the Artifact element name; enter the name and click on the OK button.</p> <p>The profile is added to the diagram's parent Package as an <<EAFeatureMapping>> Artifact, and the profile name displays at the end of the 'Profiles' sub-menu.</p>
<p>Profiles Update Current Profile</p>	<p>If you are using a profile and need to change one or more fields to a value you will continue to apply, you can update the profile with the change(s). When you select the option, the system displays a prompt to confirm that the profile has been changed.</p>
<p>Profiles Delete Current</p>	<p>If you no longer want to keep a profile, select it and then select this option. Alternatively, right-click on the <<EAFeatureMapping>> Artifact in the Browser window and select the 'Delete <element name>' option.</p>

Options

Click on this option to display the 'Feature Matrix Options' dialog, and select from these options:

- Sort Axes - select the checkbox to display the feature names in each axis in alphabetical order
- Highlight source features without relationships - select this checkbox to display, in pale blue, all cells in each row belonging to a source feature that has no relationships
- Highlight target features without relationships - select this checkbox to display, in pale pink, all cells in each column belonging to a target feature that has no relationships

Click on the OK button to action the selected options.

Connect to a Connector

Under certain circumstances, it can be useful to create a connector that issues or terminates (or both) on another connector. For example, you might create a connector between two elements, and then create a link between that connector and a Requirement element to show that the relationship between the two elements was a predefined specification of the design.

In releases of Enterprise Architect from 13.0 onwards, you can add connectors to other connectors. The linking connector can connect as source and target:

- Two other connectors
- An element and a connector
- A connector and an element

The appearance of each configuration of a connector/connector link is illustrated here:

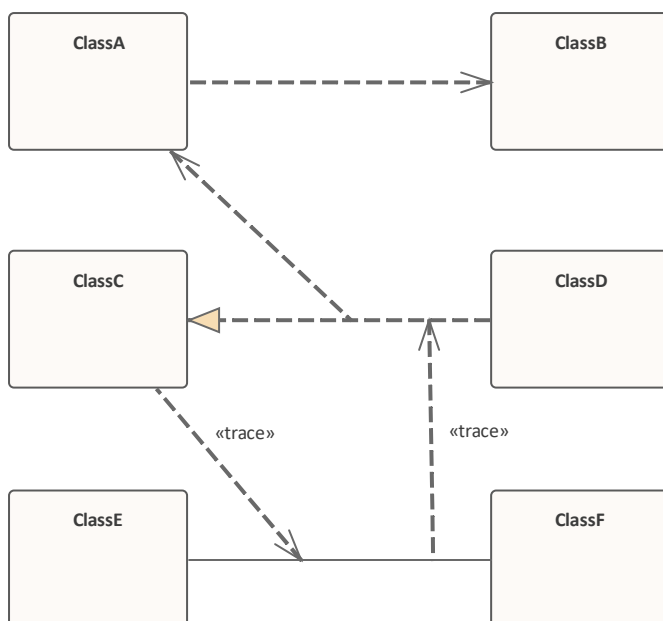

As you create the connector on another connector, the connector end displays with this circle symbol to indicate that it is on another connector, and to help you position the end accurately.

(Select connector) 

(Move connector end) 

There is effectively no limit to the number of connectors that can issue from or terminate on another connector.

Once you have anchored one connector on another, if you move either end or the whole connector and you have selected the 'Layout > Align >  > Smart Placement' and 'Show smart placement guidelines' options, colored guidelines appear on the diagram. These indicate where the selected end of the connector is relative to potential anchor points on the currently-anchored connector and others that you might drag past. Note that the objects must be contemporary - not at different hierarchical levels or in different partitions of the diagram.

Create a connector on another connector

You can create a connector that issues from or terminates on another connector in the same two ways as you create one on an element; that is:

- Using the Quick Linker arrow or
- Using a connector icon from the Toolbox

Method	Action
--------	--------

<p>Quick Linker</p>	<ol style="list-style-type: none">1. Click on the source connector (or element). A Quick Linker arrow displays at the center point of the line.2. Drag the arrow onto another connector or onto an element, to display a short menu of possible connector types; select the appropriate type. <p>You can also drag the Quick Linker arrow into empty space; a short menu of element types displays and you can select to generate an element of one of those types whilst the system automatically creates an appropriate type of connector to it.</p>
<p>Toolbox</p>	<ol style="list-style-type: none">1. Click on the icon for the required connector type.2. Click-and-drag from the source connector or element to the target connector or element. <p>Certain connector types are not UML-compliant for linking to another connector, and if you select such types you might get an error message. You can continue to create this type of connector by de-selecting the 'Strict Connector Syntax' option on the 'Links' page of the 'Preferences' dialog (the 'Start ></p>

	Application > Preferences > Preferences' ribbon option).
--	---

Add a Note to a Connector

This topic describes how you can connect notes and constraints to graphical relationships.

Notes enable you to provide explanations and further detail for one or more connectors on a diagram, with a visible Note element.

Add a note or constraint to a connector

Step	Action
1	Right-click on one of the connectors to attach a note to. The context menu displays.
2	Select the 'Attach Note or Constraint' menu option. The 'Link Relations' dialog displays.
3	Select the appropriate radio button in the Link Type panel.
4	Check all the connectors that participate in the set.
5	Click on the OK button to complete the note or constraint creation.

- | | |
|---|--|
| 6 | Use the normal 'Note' dialog to enter the appropriate text for the note or constraint. |
|---|--|

Notes

- The constraint note is drawn slightly differently to a regular note, and has { and } automatically added to visually indicate the constraint form
- As an alternative to the procedure, you can drag the Quick Linker arrow on an existing Note or Constraint, and drag it to the required connector; a Notelink is automatically created to attach the Note or Constraint to the connector

Arrange Connectors

Connectors between two elements can be moved around the element borders to create a good layout. There is a limit to how much a connector can be moved around, but generally it is very easy to find an acceptable layout. For the best layouts, use the custom line style; this enables you to add as many line points and bends as you require to create a clean and readable diagram.

Move and arrange connectors on a diagram

Step	Action
1	Click once on the connector to select it.
2	Holding the mouse button down, move the connector in the required direction.
3	To refine the movement, click and hold very near to one end of the connector; this enables a slightly different movement range.
4	To further refine the movement and range, select either a routed, direct or custom line style; each behaves slightly differently.

Change Connector Type

This topic explains how to change the type of a connector. Note that not all connector types are available, depending on the types of the source and target elements.

Access

Context Menu	Diagram Right-click on Connector Advanced Change Type
--------------	---

Change a connector type

Step	Action
1	In the 'Connector Type' field, click on the drop-down arrow and select the required connector type.
2	Click on the OK button to apply changes.

Change the Source or Target Element

After you have created a connector between two elements, you might later want to change either the source or target. Instead of deleting and re-creating the connector, Enterprise Architect enables you to change the source or target. There are two ways of doing this: using the 'Set Source and Target' dialog or using the mouse.

Using the 'Set Source and Target' dialog

Step	Action
1	Right-click on the connector to open the context menu.
2	Select the 'Advanced Set Source and Target' menu option. The 'Set Source and Target' dialog displays.
3	Click on the drop-down arrows on the 'From Element' and 'To Element' fields, and select the source and target elements.
4	Click on the OK button to apply changes.

Using the mouse

Step	Action
1	Click on the connector and position the cursor over the 'handle' at one end.
2	When the cursor changes, click the right mouse button and drag the handle to the new element.

Notes

- The connector does not actually move until you release the mouse button over the new source or target element; however:
- A dotted line shows where the connector would be during the move
- The solid outline of the nearest element or extension changes to a hatched outline as you move the cursor onto it; this helps you identify where the connector should connect to, if there are many closely-arranged elements, Parts, Ports and other extensions

Connector Styles

Connectors come in a number of different routing styles. Additionally, if one solid-line connector crosses another, the second one 'jumps' over the first (unless the 'Enable Connector line jumps' option is deselected on the 'Diagram' page of the 'Preferences' dialog). You can also bend a connector to quickly and easily route connectors in the required layout.

Styles

Style	Description
Direct	<p>A straight line from element A to element B.</p> <p>You can move the line (back and forward, up and down) to a limited degree.</p>
Auto Routing	<p>A vertical and horizontal route from A to B with 90-degree bends.</p> <p>You can move the line to improve the route, but the location and number of bends are not configurable.</p>
Bezier	<p>A smooth curved line from A to B.</p> <p>Bezier style is directly available for Data</p>

	Flow diagram connectors, Mind Mapping connectors, State Flows, State Transitions, Object Flows, and Control Flows.
Custom Line	The most flexible option; you can add one or more line points and bend and push the line into virtually any shape, using the 'Toggle Line Point at Cursor' option.
Tree Style - Vertical Tree Style - Horizontal	A line from element A to B with two right-angle bends, and the end points fixed to selected locations on the elements (Vertical or Horizontal).
Lateral - Vertical Lateral - Horizontal	A line from element A to B with a single right-angle bend, and the end points fixed to selected locations on the elements (Vertical or Horizontal).
Orthogonal - Square Orthogonal - Rounded	You can add one or more line points and bend and push the line into a variety of shapes, using the 'Toggle Line Point at Cursor' option. All line segments thus created are either vertical or horizontal.

Set the Connector Style

Step	Action
1	Right-click on the connector to change. The context menu displays.
2	Select the 'Line Style' option.
3	From the submenu, select the required style: <ul style="list-style-type: none">• Direct• Auto Routing• Custom• Tree• Lateral, or• Orthogonal• (or Bezier, where appropriate)

Set the Connector Style (alternative method)

Step	Action

1	Select the connector to change.
2	<p>Press these keys to change the style:</p> <ul style="list-style-type: none"> • Ctrl+Shift+D for Direct • Ctrl+Shift+A for Auto Routing • Ctrl+Shift+C for Custom • Ctrl+Shift+Z for Bezier (where appropriate)

Bend a connector

Step	Action
1	<p>Right-click on the connector. The context menu displays.</p>
2	<p>Set the line style to 'Custom Line' (Ctrl+Shift+C); this enables the 'Bend Line at Cursor' option in the context menu.</p>
3	<p>Click on the 'Bend Line at Cursor' option to add a line point. Right-clicking a line point displays the 'Straighten Line at Cursor' option, which you can use to remove the line point.</p>

4	Using the mouse, drag the line point to the required position.
---	--

Bend a connector (alternative method)

Step	Action
1	Hold down Ctrl or Shift and click on a point on the connector to create a line point. Ctrl+click also removes a line point.
2	Using the mouse, drag the line point to the required position.

Tidy line angles (custom connector)

Step	Action
1	Right-click on the connector. The context menu displays.
2	Click on the 'Tidy Line Angles' menu option; this

nudges the custom line in horizontal and vertical increments, saving you the time of trying to get a good layout manually.

You can set the 'Tidy Line Angles' option to operate by default; click on the 'Start > Appearance > Preferences > Preferences' ribbon option to display the 'Preferences' dialog, and select the 'Diagram Behavior' page.

Suppress individual line segments

Step	Action
1	Right-click on the connector. The context menu displays.
2	Set the line style to 'Custom Line' - press Ctrl+Shift+C. This enables the 'Suppress Line Segment' option in the context menu.
3	Click on the 'Suppress Line Segment' option to suppress a line between two bend points. The segment you right-clicked on is suppressed.

- | | |
|---|---|
| 4 | <p>To show the segment again, right-click on the line and click on the 'Show All Line Segments' option. One application for this is to represent the continuation of flow when your diagram crosses the page boundary marker in the Diagram View. When you suppress the line segment that crosses the boundary, the link name (connector properties) displays at both ends of the hidden segment; when you print the diagram on multiple pages, the link name identifies the connection apparently broken by the page boundary.</p> |
|---|---|

Create Connector in Browser Window

You can create a connector from one element to another directly in the Browser window.

Connect elements from the Browser Window

Step	Action
1	<p>In the Browser window, either:</p> <ul style="list-style-type: none">• Right-click on the element to create a connector for, and select the 'Add Create Link' option, or• Select the element, press the Insert key and select the 'Create Link' option <p>The 'Create Link' dialog displays.</p>
2	<p>In the 'Direction' field, click on the drop-down arrow and select the direction of the new connector ('Outgoing' means the selected element is the source).</p>
3	<p>In the 'Link Type' field, click on the drop-down arrow and select the type of connector.</p>
4	<p>In the 'Choose target(s)' list, click on the name of the</p>

	target. (If necessary, in the 'Select Target Type' field click on the drop-down arrow and select a feature to list only elements having that feature).
5	Click on the OK button to create the connector.

Notes

- You can also reproduce an existing connector between two elements when you paste those elements from the Browser window into a diagram as instances; an option enables you to copy just the elements, or the relationship as well

Relationship Visibility

You can change the visibility of individual connectors or relationships on an open diagram.

Access

Display the 'Set Visible Relations' dialog, using one of the methods outlined here.

Ribbon	Layout > Diagram > Appearance > Set Visible Relationships
Keyboard Shortcuts	Ctrl+Shift+I

Set relationship visibility

Step	Action
1	<p>On the 'Set Visible Relations' dialog, select the checkbox against each list item to show, and clear the checkbox against each item to hide.</p> <p>If you want to display the information in a more readable layout, you can resize the dialog.</p>

2

Click on the OK button to apply the changes.

Freeze Visible Connectors

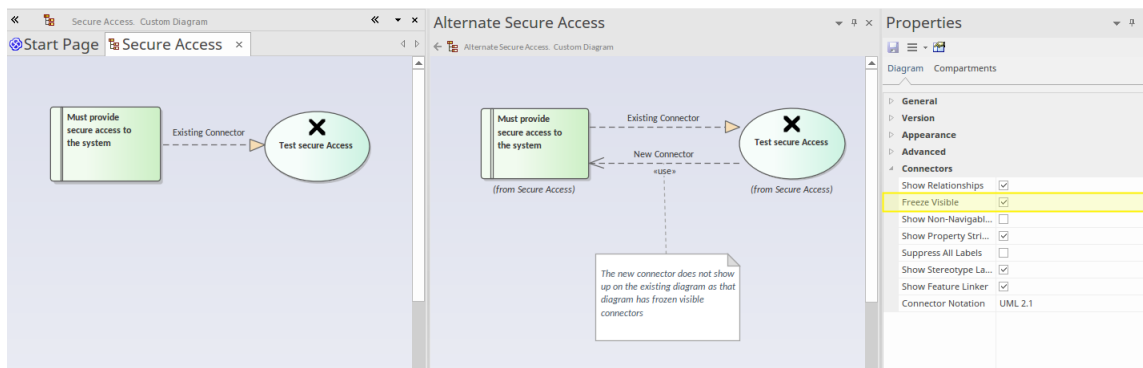

Working in a collaborative platform brings with it challenges of working with models and diagrams that are often in flux, and where a number of modelers contribute to related diagrams and models. For example a diagram could have been defined for a project iteration (sprint) and during the sprint an architect could be working on the same objects on another diagram for the next iteration, adding new relationships. Enterprise Architect's default behavior is to add these to any existing diagrams that contain the related objects. This might not be a welcomed outcome for the owner of the original diagram.

The Freeze Visible connectors feature is a useful way of ensuring that a diagram set up at a certain point is not automatically updated when new relationships are added to the repository that connect two or more objects on the diagram. By setting the diagram connectors' Freeze Visible property the diagram owner is telling the tool not to update this diagram when connectors are added somewhere else in the model.

A modeler can, of course, continue to add additional connectors to the diagram or 'unfreeze' the connectors and

reload the diagram to see the changes. This feature facilitates collaborative model creation and helps teams work together without getting in each other's way. If this situation occurs frequently it might be worth considering using the Time Aware Modeling feature, which allows new versions of existing elements to be created to model future states.

You can hide or show connectors on the current diagram or on other diagrams using the 'Links' tab of the Properties dialog; see the *Hide/Show Connectors* Help topic.

Note: Freeze Visible Connectors has no effect on Sequence diagrams because Sequence messages cannot be shown on multiple diagrams.

Access

Design your diagram, and ensure that it shows the relationships that you require. Then fix the diagram as at this point in time by selecting one of these options:

Ribbon	Start > Application > Design > Properties > Connectors : Freeze Visible (Properties window) Design > Diagram > Manage > Properties > Connectors : Freeze Visible (Properties dialog)
Context Menu options	In Browser window: Right-click on diagram name > Properties > Connectors

	<p>: Freeze Visible (Properties dialog)</p> <p>On diagram: Right-click on background > Properties > Connectors : Freeze Visible (Properties dialog)</p>
Keyboard Shortcuts	<p>Ctrl+2 > Connectors : Freeze Visible (Properties window)</p> <p>Alt+1 > Properties > Connectors : Freeze Visible (Properties window)</p>

Hide/Show Connectors

Connectors or relationships that appear in multiple diagrams can be selectively shown or hidden. This makes it easier to read diagrams where elements might have many connectors, but not all are relevant in the context of the current diagram.

Hide or show a connector in the current diagram

Step	Action
1	Double-click on the required diagram element in the Diagram view. The element 'Properties' dialog displays.
2	Select the 'Links' tab. This lists the connectors linked to the element, whether or not they are hidden on the diagram.
3	Right-click on the connector to hide or show. The context menu displays.
4	Select the 'Show Relation' option to show the hidden connector on the diagram, or the 'Hide Relation' option to hide the visible connector.

Alternatively, hide a connector by right-clicking on it on the diagram and selecting the 'Visibility | Hide Connector' option; however, you must use the 'Links' tab of the element 'Properties' dialog to show the relationship again.

Hide or show a connector in other diagrams

Step	Action
1	Right-click on the connector in the diagram. The context menu displays.
2	Select the 'Visibility Hide Connector in Other Diagrams' menu option. The 'Set Connector Visibility' dialog displays.
3	If the two connected elements have been included in other diagrams, these diagrams are listed here. In the list, all diagrams for which the checkbox is selected show the connector; deselect the checkbox for any diagrams in which to hide the connector. If you want to display the information in a more readable layout, you can resize the dialog. To hide the connector in all of the diagrams listed,

	click on the Suppress All button.
4	Click on the OK button to save the changes.

Notes

- Certain elements, such as Requirements, do not have a 'Links' tab in the 'Properties' dialog
In these cases, open the Relationships window ('Start > All Windows > Properties > Responsibilities > Relationships') for the element, right-click on the relationship in the list and select the context menu option to hide or show that relationship in the diagram
Be aware that, in the Corporate, Unified and Ultimate Editions with security on, locks on the diagram and elements can make the required option unavailable
- It is also possible to select an option that prevents relationships created on other diagrams from appearing on your current diagram - that is, you freeze your current diagram against that particular change; see the *Freeze Visible Connectors* Help topic.

Delete Connectors

This topic explains how to delete a connector from the model. Note that it is possible to either hide the connector in one or more diagrams and still retain it in the model, or remove it completely (deletion).

Delete a Connector

Step	Action
1	<p>Right-click on the connector and select the 'Delete Connector' option.</p> <p>The 'Remove Connector' dialog displays; this dialog provides the options to hide the connector so that it remains functional, or remove the connector completely.</p>
2	<p>Click on the appropriate radio button and click on the OK button.</p> <p>If you select the 'Hide' option, it has the same effect as hiding the connector on the 'Links' tab of the source element 'Properties' dialog, or using the 'Visibility Hide Connector' context menu option.</p> <p>It also hides the connector on the Relationships window.</p>

Notes

- The dialog does not display if:
 - You have previously selected the 'Don't ask again' checkbox or
 - On the 'Links' page of the 'Preferences' dialog ('Start > Appearance > Preferences > Preferences > Links') the 'Prompt on connector deletes' checkbox is not selected
- Selecting the 'Don't ask again' checkbox also deselects the 'Prompt on connector deletes' checkbox
- Selecting the 'Prompt on connector deletes' checkbox restores the dialog if you have used the 'Don't ask again' checkbox
- If you hide the dialog, the 'Delete Connector' context menu option defaults to the setting you last used on the dialog; make sure that you have selected the right option to default to

Creating Generalization Sets

A Generalization Set enables you to specify the relationship of a group of Generalizations. Each Generalization is a binary relationship that relates a specific Classifier to a more general Classifier (for example, from a Class to its Superclasses). Each Generalization Set defines a particular set of Generalization relationships that describe the way in which a general Classifier (or superclass) can be divided using specific subtypes.

Access

Context Menu	Right-click on connector Advanced Generalization Set New
--------------	--

Create a Generalization Set

Step	Action
1	Select the 'New' menu option. The 'Generalization Set' dialog displays.
2	In the 'Name' field, type the name of the

	Generalization set; for example, 'Gender'.
3	In the 'Power Type' field, either: <ul style="list-style-type: none">• Type a new power type, or• Click on the drop-down arrow or  and select an existing one from the 'Select <Item>' dialog
4	Consider the 'Is Covering' checkbox. If you select this, on a diagram the constraint {complete} will be added to the label of each generalization that is a member of the set. (If you do not select the checkbox, the constraint is regarded as {incomplete} although this is not displayed in the label).
5	Consider the 'Is Disjoint' checkbox. If you select this, on a diagram the constraint {disjoint} will be added to the label of each generalization that is a member of the set. (If you do not select the checkbox, the constraint is regarded as {overlapping} although this is not displayed in the label).
6	In the 'Is Member' column, select the checkbox against each child subtype that is part of this Generalization set.
7	Click on the OK button to save and apply the Generalization Set, and to close the dialog.

Connector In-place Editing Options

You can edit many of the Enterprise Architect connector labels directly on the diagram. Each label can be bound to a single connector field.

Put a label in Edit mode

To put a label into Edit mode, either:

- Select the 'Edit Label' option from the context menu, or
- Select a label and press F2

To save the current text to the field, either press the Enter key or deactivate the Edit window.

To cancel edit mode without saving any changes, press Esc.

Reverse Connector

You can reverse the direction of a connector without having to delete and re-create it. This is helpful if your design changes or you add the connector wrongly to begin with.

Reverse the direction of a connector

Step	Action
1	Right-click on the incorrect connector.
2	Select the 'Connection Detail Reverse Direction' context menu option.

Set Association Specializations

UML enables specialization of properties defined by Associations. Enterprise Architect enables this through the 'Specialize Associations' option in the 'Advanced' section of the context menu for an Association.

A dialog displays, showing all Associations between the two Classes connected by the current Association and their parents.

The left two columns define the source role of the current Association, while the right two define the target role. With this you are able to select the relationships of each end of the properties listed. When a relationship is set then this is drawn at the corresponding end of the connector on any diagram it appears on.

The dialog displays when you select the 'Advanced | Specialize Associations' context menu option on the lowest Association connector in this diagram.

Example

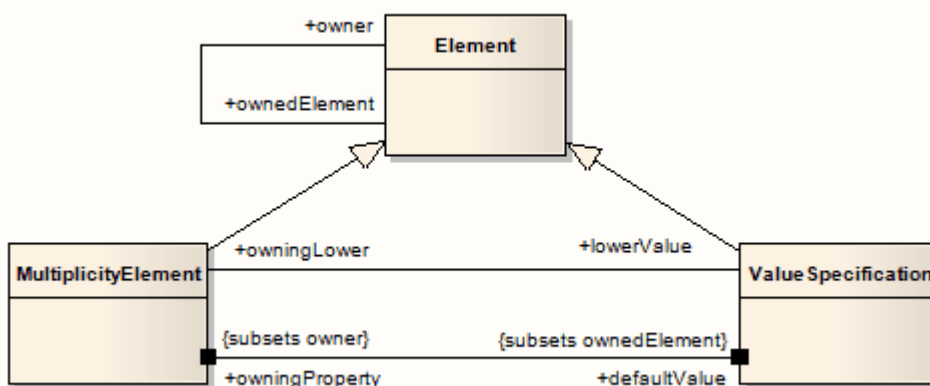

Change Sequence Message Scope

A message in a Sequence diagram represents a dynamic interaction from one element to another. Sometimes when you are designing your model you might have to change either the start or end point of a message as the responsibilities of elements change during design. For this reason, Enterprise Architect enables you to change the message scope by setting a new start or end element.

Change Message Scope

Step	Action
1	Select the message in the Sequence diagram.
2	Right-click on the message to open the context menu.
3	Select 'Advanced Set Source and Target'.
4	In the pop up dialog, in the 'From Element' and 'To Element' fields, click on the drop-down arrows and select the required elements.
5	Click on the OK button to save changes. The message is re-routed to meet your changed

	requirements.
--	---------------

Show Uses Arrow Head

By default the Use connector in Use Cases has no arrow head.

Generate arrow heads on Use connectors

Step	Action
1	<ul style="list-style-type: none">• Select the 'Start > Appearance > Preferences > Preferences > Links' option. The 'Links' page of the Preferences window displays.
2	In the 'General' panel, select the 'Show Uses arrowheads' checkbox.
3	Click on the Close button. When you save the Use Case diagram, the Use connectors change to display arrowheads.

Tree Style Hierarchy

In Enterprise Architect you can create a tree style inheritance diagram using a special form of the Generalization connector, as shown.

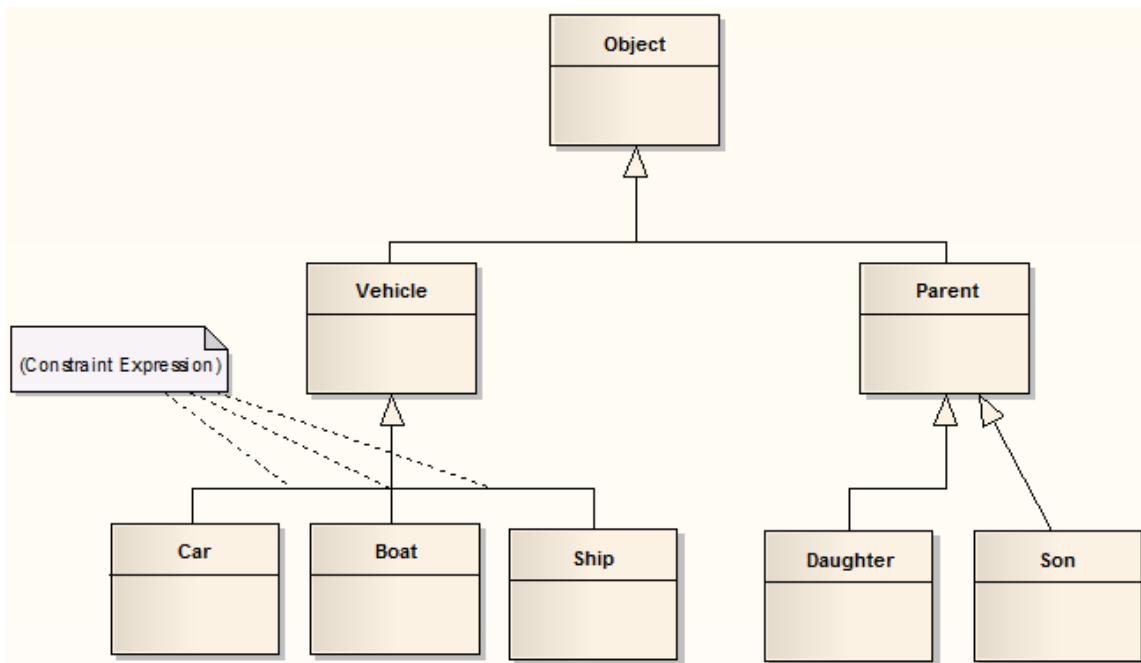

Create a tree style connector

Step	Action
1	Create a normal Generalization between two elements.
2	Right-click on the connector to open the context menu.

3	Select the 'Line Style Tree Style - Vertical' or the 'Line Style Tree Style - Horizontal' menu option.
4	<p>Enterprise Architect automatically makes the Generalization layout conform to a specific shape. By adding more Generalization connectors, and checking their Tree Style options, you can achieve the appearance of the example diagram.</p> <p>You can slide the root and child Classes left and right to achieve the required result; Enterprise Architect maintains the conformity of the branch connectors.</p>

Set this style of connector as default

Notes

- In the example diagram, the Son -> Parent connector has not yet been put in Tree Style - Vertical style
- This style of diagram provides a clearer layout for inheritance hierarchies and is easy to work with

Step	Action
1	<p>Select the 'Start > Appearance > Preferences > Preferences > Links' option.</p> <p>The 'Links' page of the Preferences window displays.</p>

- | | |
|---|---|
| 2 | Select the 'Generalization link style Default = Tree' checkbox to make this branching style the default style for inheritance connectors. |
|---|---|

Tagged Values

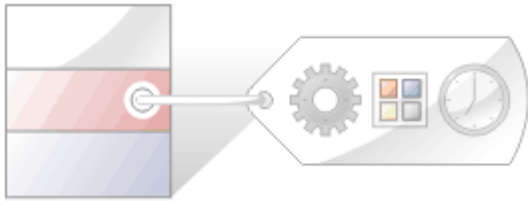

Tagged Values are additional properties that can be assigned to UML elements and connectors. The UML defines properties such as name and description for elements and connectors, and Enterprise Architect adds a number of additional properties such as status, phase and author, but Tagged Values provide a means of defining your own properties (tags) and their values.

For example, a requirements modeler might want to record the owner of a set of Requirements. The UML doesn't specify this property, but it can be easily added as a tag. A tag named Requirement Owner could be created and then each Requirement element could be assigned a value for the owner. This information would also be available in documentation.

Enterprise Architect has enriched the basic concept of Tagged Values with its comprehensive structured Tagged Value facility. To assist you when entering data, the values can be restricted using user interface controls such as drop down lists, spin controls, date selectors and many more.

Tagged Values are widely used in profiles and technologies to add information that helps guide the presentation of elements or metadata for code or schema generation.

The Tagged Values tab

The 'Properties' dialog and Properties window both have 'Tag' tabs that you can use to view and modify Tagged Values for a modeling item selected either from the current diagram or in the Browser window. On the tab you can:

- Assign a Tagged Value to an Item
- Modify Tagged Values
- Assign Notes to a Tagged Value
- Perform advanced tag management

Note that Tagged Values from stereotypes are not displayed on the 'Tags' tab, but in the:

- Properties window, in a section of the main page underneath the 'General' page and
- 'Properties' dialog, on a separate <extension name> tab

Model Elements and Features with Tagged Values

These model components can use the 'Tagged Values' tab as a convenient way to quickly view and modify Tagged Values:

- Elements - display their own tags, along with any inherited values
- Object Instances - display their own tags and those obtained from their classifier
- Ports and Parts - display similar information to objects but

show the Port/Part 'Type' instead of a classifier; tags are included for all parents and other structures of the Ports type

- Attributes - display their own tags and those received from attribute type classifiers, with the inclusion of any inherited tags
- Operations - display their own tags
- Connectors - display their own tags

When over-riding an inherited property, the system copies the tag from the parent down to the child element and sets the new value, leaving the original tag unchanged.

Tagged Values Toolbar Buttons

Using the buttons from the toolbar at the top of the 'Tags' tab in the Properties window or dialog, you can add, edit, sort, delete and re-arrange the Tagged Values of model features.

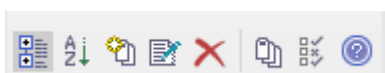

From left to right, the button functions are:

- Show in compartments - displays the Tagged Values in element compartments on diagrams
- Sort and Show Alphabetically - sorts the current Tagged Values alphabetically for the element
- New Tagged Value - adds a new tag, to which you assign a value
- Edit Tagged Value Notes - opens a note in which you type

an explanation of the purpose of the Tagged Value

- Delete Tagged Value - removes the currently selected Tagged Value
- Default Tagged Value Types - provides quick access to tag definitions created using the 'Settings > Reference Data > UML Types > Tagged Value Types' ribbon option
- Tagged Value Options - provides options to show or hide the fully qualified paths for the Tagged Values in the window, and to show duplicate Tagged Values
- Help - displays information on the use of Tagged Values

Quick Start - Add Tagged Value To Elements

You can quickly add a single Tagged Value to one or more elements within a diagram, using a context menu option.

Access

Context Menu	On a diagram, select one or more elements, and right-click on one; select the 'Add Tagged Values' context menu option
Other	On a diagram, select one or more elements, and click on the  icon at right end of the Element toolbar

Add a Tagged Value to elements

Step	Action
1	On the 'Tagged Values' dialog, in the 'Tag' field, type in the tag name. (Do not use the drop-down arrow to

	select an existing tag type.)
2	In the 'Value' field, type in the value for the tag.
3	Click on the OK button to add your new Tagged Value to the currently selected elements.

Notes

- To delete the Tagged Value, open the Properties window for the element, click on the 'Tag' tab and the tag name, and click on the 'Delete' icon
- To add notes to the Tagged Value, in the 'Tag' tab click on the Tagged Value name, and click on the  button in the tab toolbar; the 'Notes' dialog displays
- The notes are displayed in the lower portion of the Properties window (only if the 'Hide Properties Info Section' checkbox is not selected in the 'Window Behavior' tab of the 'Preferences' dialog - select the 'Start > Appearance > Preferences > Preferences > General > Window Behavior' ribbon option; if you change the setting of this option, you might have to restart Enterprise Architect to make the change take effect)

Assign a Tagged Value to an Item

You can assign Tagged Values to a range of model objects, including elements, object instances, connectors, attributes and operations, using the 'Tags' tab of the Properties window. You would probably have the window open already as a docked window, and any object you select becomes the focus of the window; you can then review and add or delete Tagged Values for that object.

Access

Ribbon	<p>Start > All Windows > Properties > General > Tagged Values</p> <p>Design > Element > Properties > General > Tagged Values</p>
--------	--

Assign a Tagged Value to an item

Step	Action
1	Select the model feature to which to assign a Tagged Value. This feature becomes the focus of the window.

2	<p>In the 'Tags' tab of the Properties window, either click on the  icon or press Ctrl+N.</p> <p>The 'Tagged Value' dialog displays.</p>
3	<p>In the 'Tag' field type the tag name, or click on the drop-down arrow and select the appropriate tag to assign to the item. The list of tags to select from is filtered by the Perspective that is currently set for the model.</p>
4	<p>If appropriate, type a specific value for the tag in the 'Value' field.</p>
5	<p>To confirm selection of the Tagged Value, click on the OK button.</p>

Assign Notes to a Tagged Value

Once a Tagged Value has been assigned to a model feature, you can add information and notes describing the Tagged Value to the information property of the Tagged Value.

Access

Ribbon	Start > All Windows > Properties > General > Tagged Values Design > Element > Properties > General > Tagged Values
--------	---

Assign a note to a Tagged Value

Step	Action
1	Click on the model feature for which to edit the Tagged Values. Its Tagged Values display in the 'Tags' tab of the Properties window.
2	Click on the Tagged Value to add information to.

3	Click on the  button or press Ctrl+E. The 'Tagged Value Note' dialog displays.
4	In the 'Note' field, type the information relating to the Tagged Value. Click on the OK button.
5	The information is displayed in the lower portion of the Properties window whenever the Tagged Value is selected.

Notes

- The notes are displayed in the lower portion of the Properties window only if the 'Hide Properties Info Section' checkbox is not selected in the 'Window Behavior' tab of the 'Preferences' dialog (select the 'Start > Appearance > Preferences > Preferences' ribbon option and the 'General > Window Behavior' tab); if you change the setting of this option, you might have to restart Enterprise Architect to make the change take effect

Modify Tagged Values

Once a Tagged Value has been assigned to a model feature (such as an element or connector), it is possible to edit the values in the 'Tags' tab of the Properties window.

Access



Ribbon	<p>Start > All Windows > Properties > General > Tagged Values</p> <p>Design > Element > Properties > General > Tagged Values</p>
--------	--

Edit Tagged Values

Step	Action
1	<p>Click on the model feature for which to edit the Tagged Values.</p> <p>The 'Tags' tab shows all of the tags for the selected feature, each with their current value.</p>
2	<p>Edit the fields as appropriate; the information entered can only reflect the value types that have</p>

been defined by the tag's Tagged Value Type.

There are six types of value field for a Tagged Value:

- 'Open' fields, in which you can type any appropriate value
- Structured Tags, where you do not directly edit the composite value but expand the tag to show the component tags and edit the component values in 'open' fields; the composite value updates as you click off the component field
- 'Drop-down list' fields, where you click on the drop-down arrow to select from a discrete list of possible values such as 'M' or 'F', or 'Win', 'Lose' or 'Draw'
- 'Spin' fields, where you click on up or down arrows in the field to increase or decrease the value within certain limits
- Checklist fields, where you click on the  button in the field to display the 'Check List' dialog, which lists a set of items that can be selected by ticking the checkbox against each item; if any checkboxes are not selected the value of the tag is 'Incomplete', and when all checkboxes are selected the tag value is 'Complete'
- 'Further detail' fields, where you click on the  button in the field to display a dialog in which you enter information (such as notes) or indicate a source of further information (such as a classifier)

Notes

- To override a Tagged Value defined in a parent element, edit the value in the 'from <parentname>' compartment of the 'Tags' tab; once this has been done the tag is moved into the selected element's Tagged Values - this does not affect the Tagged Values defined in the parent element

Show Duplicate Tags

Tagged Values are by default set to hide duplicate values. This setting is used to facilitate inherited and overridden tag names.

Access

Ribbon	Start > All Windows > Properties > General > Tagged Values Design > Element > Properties > General > Tagged Values
--------	---

Set the Tags tab to show duplicate values

Step	Action
1	On the 'Tags' tab toolbar, click on the  (Options) icon.
2	Select the 'Show Duplicate Tags' option.

Alternatively

Step	Action
1	Select the 'Start > Application > Preferences > Preferences' option. The Preferences window displays.
2	From the hierarchical tree, select the 'Objects' item.
3	Select the 'Show Duplicate Tags' checkbox.

Notes

- In either procedure, to hide duplicate values again deselect the option or checkbox

Advanced Tag Management

Tagged Values can also be managed within a type hierarchy and with respect to element instances, using the 'Tags' tab of the Properties window. It is possible to:

- View Tagged Values inherited from parent Classes or realized interfaces or applied stereotypes
- Override Tagged Values derived from parents or applied stereotypes with a unique value for the current element
- Delete Tagged Values from the current element (if a parent version of the Tagged Value exists, it re-appears in the list after the override is deleted)

For a reference Tagged Value (of type RefGUID), it is also possible to locate and select the object that the Tagged Value refers to, in the Browser window. Simply right-click on the Tagged Value name in the 'Tags' tab and select the 'Find in Project Browser' option.

Tag Hierarchy

This diagram illustrates a complex tag hierarchy and the way Tagged Values can be either inherited or overridden in specialized Classes to create the final tagged property set for an element. A similar concept applies to instances, where the full tag set is created from the directly owned tags, plus all of those merged in from the classifier's type hierarchy, additional stereotypes and realized interfaces.

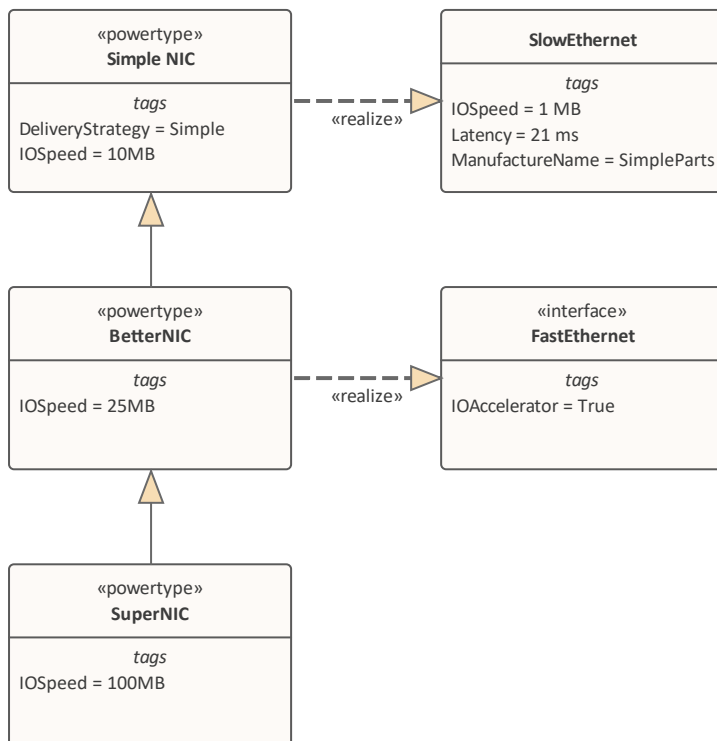

Class (SuperNIC)	
IOSpeed	100MB
from BetterNIC	
from Simple NIC	
DeliveryStrategy	Simple
IOSpeed	10MB
from FastEthernet	
IOAccelerator	True
Interface	
from SlowEthernet	
IOSpeed	1 MB
Latency	21 ms
ManufactureName	SimpleParts

Attributes

Attributes define the properties or internal data elements of an element. Not all element types support attributes, and others have restrictions; for example, attributes of Interfaces must have Public scope. In the Browser window, elements with attributes (typically Classes) have their attributes listed under the element name, each preceded by a blue box (◊). When depicted in diagrams, the attributes are listed in the first properties compartment of the element, as shown in this Customer Class example.

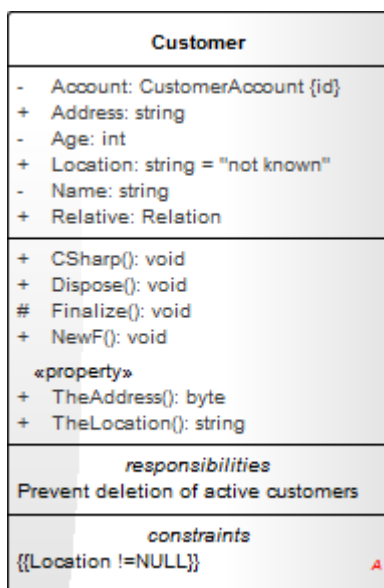

Attributes themselves have several important characteristics, such as type, visibility (scope), derivation and notes.

Access

Ribbon	Design > Element > Features > Attributes (Features window)
--------	---

	<p>(Click on an attribute) Design > Element > Features > Features Dialog ('Attribute' dialog)</p>
<p>Context Menu</p>	<p>These options display the 'Attribute' dialog</p> <ul style="list-style-type: none"> • Right-click on the attribute in the 'Project' tab of the Browser window Properties Properties • Right-click on the attribute in the 'Details' tab of the Inspector window Edit <attribute name> • Right-click on the attribute in a diagram View Properties <p>These options display the Features window:</p> <ul style="list-style-type: none"> • Right-click element in Browser window or diagram Features Attributes or • Right-click attribute in Browser window Properties All Features
<p>Keyboard Shortcuts</p>	<p>These options display the Features window when you click on an element in the Browser window or a diagram:</p> <ul style="list-style-type: none"> • F9 or • Ctrl+5 <p>This option displays the Features window</p>

	<p>when you click on an attribute in the Browser window or a diagram:</p> <ul style="list-style-type: none"> • Ctrl+5 <p>This option displays the 'Attribute' dialog when you click on an attribute in the Browser window or a diagram:</p> <ul style="list-style-type: none"> • F9
Other	<ul style="list-style-type: none"> • In the 'Details' tab of the Inspector window, double-click on an attribute to display the 'Attribute' dialog • In the 'Project' tab of the Browser window, double-click on an attribute to display the parent element on a diagram

Maintain Attributes

Action	Detail
Create and Modify Attributes	On the 'Attributes' page of the Features window, you can create and modify attributes.
Move and Copy	You can copy or move existing attributes between elements, if the target element

Attributes	also supports attributes.
Define Properties	You can create property implementations specific to your coding languages for each attribute.
Identify Inherited Attributes	The attributes of an element can be inherited from one or more successive parent elements in the model. On a diagram, you can show which attributes are inherited from which 'owning' element in the hierarchy.

Notes

- Attributes, with Operations, Receptions, Interaction Points and Connection Points, are collectively referred to as Features of an element
- If you are creating many attributes, go to the 'Attribute/Operations' page of the 'Preferences' dialog ('Start > Appearance > Preferences > Preferences > Source Code Engineering > Attribute/Operations') and de-select the 'After save, re-select edited item' checkbox; now, when you create an attribute and click on the Save button, the 'Attribute' page fields clear ready for you to enter the details of the next attribute - this helps you when you want to create attributes quickly and might not necessarily want to fully define each one as you create it

- If the parent element provides source or target roles for a connector, the connector can be attached to a specific attribute (as a feature)
- An alternative method of creating relationships between elements and attributes is to drag an attribute onto an Activity diagram, which generates an Object element named after the attribute; you then create relationships to and from this Object element

Create and Manage Attributes

The Features window presents a tab displaying the attributes that you create in an element. When you display the 'Attributes' tab, you can create and manage attributes using the page itself and a context menu of options.

Access

Ribbon	<p>Start > Design > Features > Attributes (Features window)</p> <p>(Click on an attribute) Design > Element > Features > Features Dialog ('Attributes' dialog)</p>
Context Menu	<p>These options display the 'Attribute' dialog</p> <ul style="list-style-type: none"> • Right-click on the attribute in the Browser window Properties Properties • Right-click on the attribute in a diagram View Properties <p>These options display the Features window:</p> <ul style="list-style-type: none"> • Right-click element in Browser window or diagram Features Attributes or

	<ul style="list-style-type: none"> • Right-click attribute in Browser window Properties All Features
Keyboard Shortcuts	<p>These options display the Features window when you click on an element in the Browser window or a diagram:</p> <ul style="list-style-type: none"> • F9 or • Ctrl+5 <p>This option displays the Features window when you click on an attribute in the Browser window or a diagram:</p> <ul style="list-style-type: none"> • Ctrl+5 <p>This option displays the 'Attribute' dialog when you click on an attribute in the Browser window or a diagram:</p> <ul style="list-style-type: none"> • F9
Other	<p>In the Browser window, double-click on an attribute to display the parent element on a diagram.</p>

Create a New Attribute

Either:



- Click on the *New Attribute...* text and type a name for the new attribute

- Right-click on the panel and select 'Add New' (or press Ctrl+N) or
- Right-click on an existing attribute and select 'Copy as New' (or press Ctrl+C), provide a new name for the attribute and click on the OK button

A new attribute entry displays in the list.

Edit Attribute Properties

Option	Action
Name	If you want to change the attribute name, click on the field and overwrite it with the new name.
Type	<p>Defaults to 'int'. To change this, overwrite the field or click on the drop-down arrow and click on:</p> <ul style="list-style-type: none"> • The required type or • '<none>' for no type, or • 'Select Type' and browse for the appropriate attribute classifier (you can add a new one if there are no classifiers that suit) <p>The type can be defined by the code language (data type) or by a classifier element; when you click on the</p>

	<p>drop-down arrow, the set of values in the list provides the data types, and the 'Select Type' browser provides the possible classifiers.</p> <p>To add new code language data types that can be displayed in this list, see the <i>Data Types</i> topic.</p>
Scope	<p>Define the attribute as Public, Protected, Private or Package; if necessary, click on the drop-down arrow and select a different scope.</p>
Stereotype	<p>(Optional) Define one or more stereotypes for the attribute; either:</p> <ul style="list-style-type: none"> • Type a stereotype name, or • Click on the  button and select the stereotype from the 'Stereotypes for <object name>' dialog
Alias	<p>(Optional) Type an alternative name or reference for the attribute.</p>
Initial Value	<p>(Optional) Either:</p> <ul style="list-style-type: none"> • Type in a simple initial value, or • Click on the  button and construct a more complex value on the Default Initial Value window

Context Menu options

Right-click on the panel, or on a specific attribute name.

Option	Action
Add New	Add a new attribute to the list, with default values in the dialog fields. Shortcut: Ctrl+N
Copy as New	Copy a selected attribute as a new attribute. Provide a new name for the attribute and click on the OK button. Shortcut: Ctrl+C
Properties Window	Display the Properties window, showing the details for the selected attribute and enabling you to add more-advanced properties and Constraints.
Qualifiers	Add Qualifiers to the selected attribute. The 'Qualifiers' dialog displays.
Restore Sort Order	If you have used the column header arrows to reorganize the sequence in which the attributes are displayed, click on this option to redisplay them in the

	default sequence (alphabetical by name).
Move up	Move the selected attribute one row up the list. Shortcut: Ctrl+Up Arrow
Move down	Move the selected attribute one row down the list. Shortcut: Ctrl+Down Arrow
Field Chooser	Display the 'Field Chooser' dialog, which contains any column headings not currently applied to the page. Drag a column heading from the 'Field Chooser' into the preferred position in the row of column headings. You can also drag the column headings into a different sequence. To return a column heading to the 'Field Chooser', drag it out of the heading row.
Enable Group Box	Show or hide the Group Box, in which you reorganize the list sequence of the attributes according to one or more characteristics.
Toggle Filter Bar	Show or hide the Filter Bar, in which you type text strings that the data in the corresponding column must match in

	order to be listed.
Delete	Immediately delete the selected attribute from the element. Shortcut: Ctrl+Del

Notes

- By default, the attributes are listed in alphabetical order; before being able to change this sequence with the 'Move Up' and 'Move Down' options, you must deselect the 'Sort Features Alphabetically' checkbox on the 'Objects' page of the 'Preferences' dialog ('Start > Appearance > Preferences > Preferences > Objects') - the system prompts you to allow it to make this change for you
- You can add Notes on the attribute through the Notes window, which has focus on the attribute while it is selected in the Features window; similarly, you can assign Tagged Values to the attribute through the 'Tags' tab of the Properties window

Attribute Tagged Values

Tagged Values are a convenient means of extending the properties a model element supports, including attributes. Such extensions can then be used by code generators and other utilities to transform UML models into other forms.

Access

Ribbon	Design > Element > Properties > General > Tagged Values, click on an attribute Start > All Windows > Properties > Tagged Values, click on an attribute
Keyboard Shortcuts	Ctrl+2 > Tags

Add a Tagged Value to an attribute

Step	Action
1	Click on the  button in the window toolbar. The 'Tagged Value' dialog displays.

2	In the 'Tag' field, type the tag name or click on the drop-down arrow and select a defined tag.
3	In the 'Value' field type a specific value for the tag. (For some types of Tagged Value, the 'Value' field is grayed out. In this case, continue to step 4 and enter the value against the tag name in the 'Tags' tab of the Properties window or 'Properties' dialog.)
4	Click on the OK button to confirm the operation. The tag name and value are displayed under the attribute name in the 'Tags' tab of the Properties window.

Notes

- Tagged Values are supported for attributes, operations, objects and connectors
- You can define custom tags by creating a Custom Tagged Value Type

Display Inherited Attributes

When displaying a Class with attributes in a diagram, you can also show the inherited attributes from all parents in the element's type hierarchy (that is, the element's ancestors).

Access

Context Menu	Right-click element on diagram Compartment Visibility
Keyboard Shortcuts	Ctrl+Shift+Y

Enable Display of Inherited Attributes

In the 'Show Element Compartments' panel, select the 'Inherited Attributes' checkbox.

You can also override an inherited attribute's initial value, selecting the 'Features | Override Attribute Initializers' option to display the 'Override Attribute Initializers' dialog.

When you view the inherited attributes, the system merges the list of attributes from all ancestors and applies the attribute initializers, so that the final child Class displays the correct attribute set and initial values.

Option	Action
Variable	Click on the drop-down arrow and select the variable name.
Operator	Click on the drop-down arrow and select the appropriate operator.
Value	Type a new initial value.
Note	Type in any comments or notes concerning the variable.
OK	Click on this button to save the variable and close the dialog.

Example

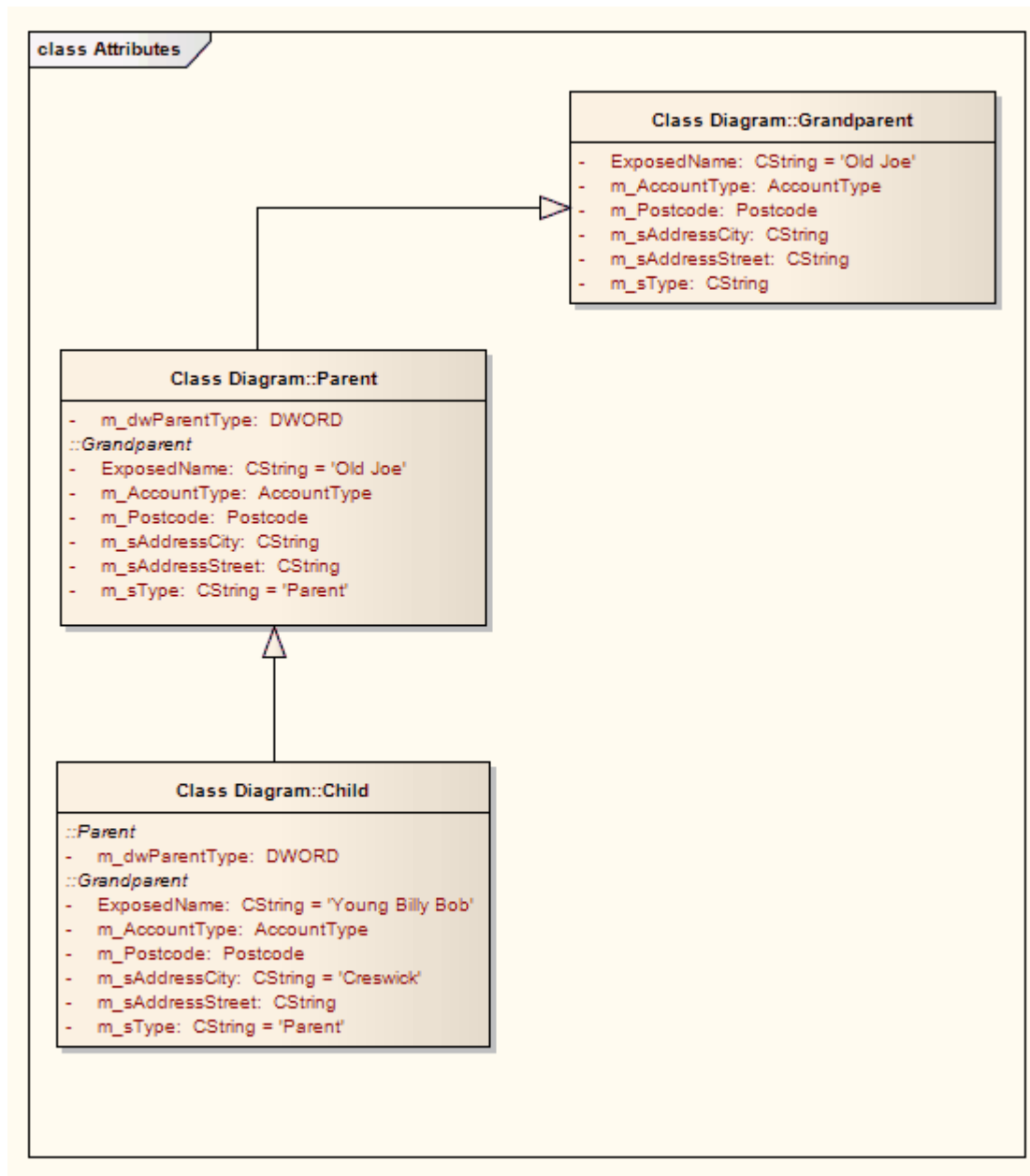

Create Object From Attribute

If you drag an attribute from the Browser window onto an Activity diagram, the attribute generates an Object element of the same name.

This is very useful for creating connectors between elements and specific attributes. For example, a Class element of stereotype <<table>> defines its fields as attributes; Action elements that define the use or update of those fields can then be linked to the appropriate table fields via the attribute Object elements.

Example

In this example diagram, the invoice Object was generated by dragging the invoice attribute from the Billing Details Class in the Browser window onto the diagram.

The user then created Object Flow relationships between the Receive Invoice Action element and the invoice element, and between the invoice element and the Make Payment Action element.

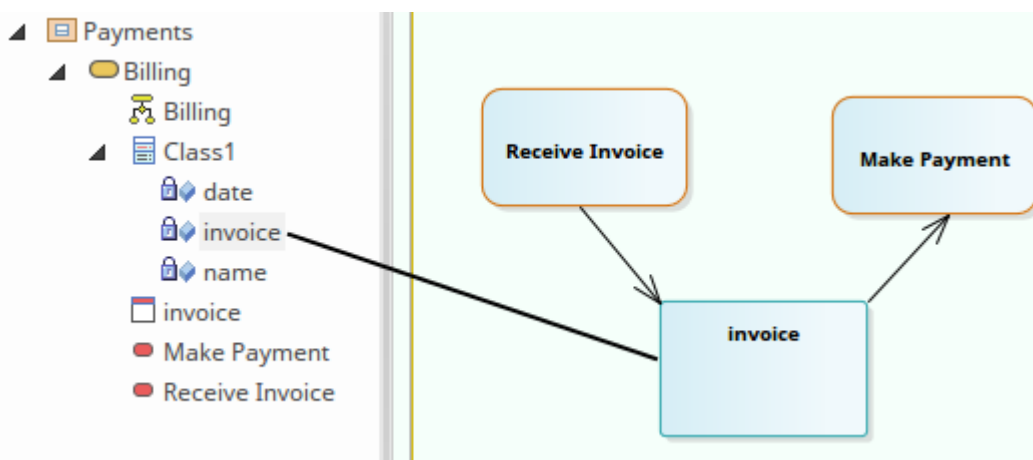

Notes

- You can also create this relationship more directly by linking an attribute in an element to another element, or linking two attributes in different elements

Classifiers and Instances

Some types of element (such as Classes) model classifications, which provide a specification of an abstract concept. For example, the concept of a Building can be represented by a set of Classes that define types of building such as Bungalow, Miner's Cottage, Office Block, Shop and so on. Other types of element (such as Objects) model instances of such classifications, such as 23 High Street Shop or 45 Village Green Cottage. The instance elements represent actual objects in a run-time scenario, based on the specification of the classifier element. For example:

- An Object element represents a man called Joe Smith, as a specific instance of the concept of 'a person' defined by the Class element Person; the object is rendered as a rectangle showing the name of the classifier - if you name the object it becomes `<ObjectName>:<ClassifierName>` or, in this example, Joe Smith:Person

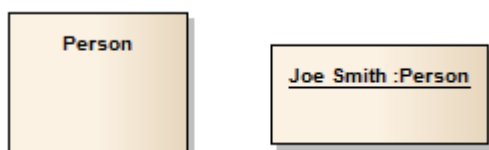

If you develop a Person Class with attributes such as Age, Name, Address and Sex, and functions such as GetAge and GetName, then when you derive an object from that Class the object takes on all the Person Class behavior and state (as well as inherited state and behavior from the parent elements of the Person Class, if any).

Associating an instance with a classifier greatly increases

the descriptive power of the model in capturing the functionality and responsibility of objects and their associated state at run-time. This is an effective means of moving your model from the analysis phase into detailed design.

Notes

- An object is an instance of a classifier at runtime, so the object's features are actually those of the classifier; in the context menu for a classified object, if you select the 'Features | Attributes' or 'Operations' menu options, the Features window displays for the classifier, not the object
- Similarly, if you have set the classifier for an object in a Sequence diagram, when you add a message and display the Properties window for the Message, the 'Message' drop-down list is drawn from the operations of the target object's classifier, not from the object itself
In this way you can associate Sequence diagram objects with Classes and use the defined behavior of the Class to model actual behavior at run time; the same concept applies to Messages for a State Flow connector
- In the Properties window, you can also select to include messages defined in the inheritance hierarchy of the classifier for the target object

Classify an Object

Objects can be created and classified in a number of ways. You can define a classifier first and then create instances of that classifier. Alternatively, you might develop several separate objects that turn out to have a similar specification, which you then formally define as a classifier. You would then classify the existing objects as instances of that new classifier.

Methods of Classifying an object

Method	Detail
Drop Classifier Onto Diagram	<p>Drag an existing classifier element from the Browser window onto a diagram. Depending on how you configure the 'Drop <element> from Project Browser' dialog, you can create an associated object as an instance, or the instance is automatically generated.</p> <p>If your classifier contains Property elements, you also have the option of adding some or all of these properties to the instance as 'slots'.</p>
Classify Existing	<p>(Where both object and classifier already exist, separately.)</p>

Object	<p>On a diagram, right-click on the object and select the 'Advanced Instance Classifier' option. (Or click on the object and press Ctrl+L.) You can also click on the object in the Browser window and press Ctrl+L.</p> <p>The 'Select Classifier' dialog displays. Browse or search through the model for the classifier element to associate with the object, and double-click on it.</p> <p>The object is associated with the classifier and displays the naming convention as described.</p>
Classify new or existing object from classifier Associations	<p>A classifier is usually a component of a model structure, and can have Associations with other classifiers.</p> <p>If an object is classified, any other objects related to that object can be classified by the related elements of the classifier. For example:</p> <ul style="list-style-type: none">• Class A is associated with Class B and Class C• Object 1 is classified by Class A• If you create an Association between Object 1 and Object 2, the 'Choose an Association Connector' dialog offers the option of setting either Class B or

	<h2>Class C as the classifier of Object 2</h2>
--	--

Add Property Slots to Instance

A classifier element can have a range of characteristics that are automatically applied to an instance based on that classifier. You can also, optionally, add any Property elements (Ports, Parts and Expose Interfaces) on the classifier to the instance, as 'slots' for the definition of each Property. This provides some flexibility in creating variations of the design defined in the classifier. For example, models of car might have doors of the same specification, but in a two-door or four-door configuration.

Add classifier Property elements to an instance

Step	Action
1	Create and save the classifier element with the configuration of Property elements you need.
2	Create or assign an instance of the classifier on your work diagram.
3	Right-click on the instance and select the 'Features' option. The Features window displays at the 'Parts / Properties' tab, listing the Property elements defined

	for the classifier.
4	<p>Select the checkbox against each Property to reproduce in the instance element, and click on the Close button.</p> <p>Each Property element is shown in the top left of the instance; drag the elements into the arrangement you want. The Property element name within the instance is prefixed with a / character.</p>

Classify Object Via Classifier Associations

When building an instance model from a predefined Class model, Enterprise Architect can assist in setting classifiers and role names for objects involved in a relationship. For example, if ClassA has association relationships with ClassB and ClassC, you can create an instance of ClassA (ObjectA), then draw an association to a new unclassified object and have the choice of selecting ClassB or ClassC as the classifiers of the new object.

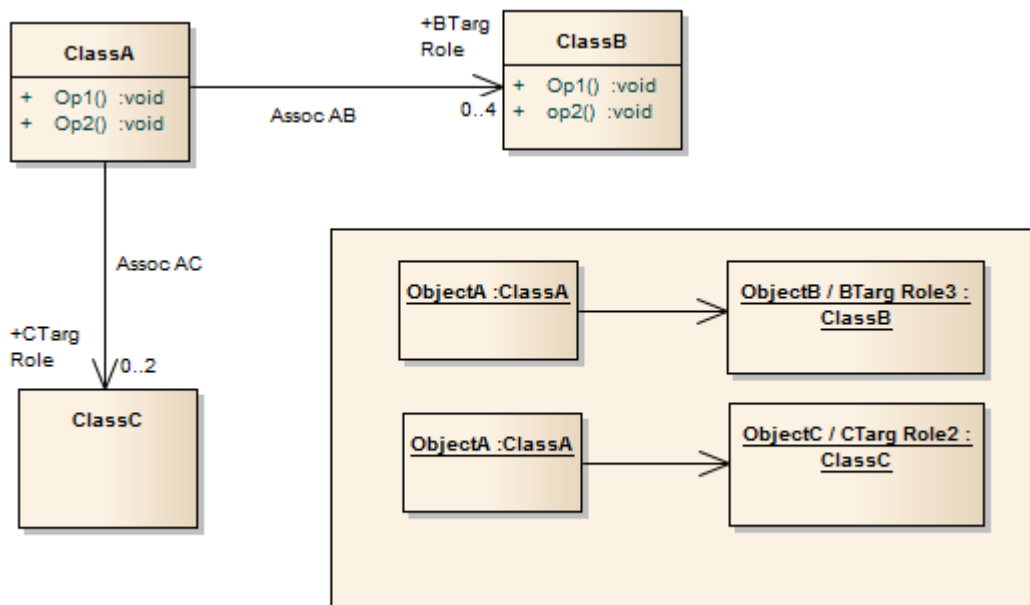

Access

Where you have an existing association between a classified object and an unclassified object, use either method outlined here, to display the 'Choose an Association' dialog.

--	--

Context Menu	Right-click on existing Association Advanced Instance Classifier
Keyboard Shortcuts	Select the existing Association : Ctrl+L

Choose an Association Connector dialog

Field/Button	Action
Classifier Name	<p>Displays the name (if defined) of each Association connector issuing from the source object's classifier.</p> <p>If the connector has no name, the value <anonymous> displays.</p>
Association	<p>Represents the source and target classifier elements in each Association connector issuing from the source object's classifier.</p> <p>If you select one of these, the target classifier becomes the classifier for the target object element.</p> <p>Select <none> if you want to create the Association, but not based on the classifier relationships.</p>

<p><Source Object Name> Role</p>	<p>Identifies any Roles defined in the Association for the source classifier element, according to the source role multiplicity setting; if you select one of these roles, this will become the specific Role for the source object, as shown on the name of the element on the diagram. If the multiplicity is not set, or the upper bound is * (asterisk), just the role name displays in the list.</p>
<p><Target Object Name> Role</p>	<p>Identifies any Roles defined in the Association for the target classifier, according to the target role multiplicity setting; if you select one of these roles, it will become the specific Role for the target object as shown on the name of the element in the diagram (and on the 'Binding' page of the Association connector 'Properties' dialog). If the multiplicity is not set, or the upper bound is * (asterisk), just the role name displays in the list.</p>
<p>OK</p>	<p>Click on the Association and source and target roles, then click on this button to:</p> <ul style="list-style-type: none"> • Create the Association between the two objects based on the relationship between the two classifiers, and

	<ul style="list-style-type: none">• Make the target classifier the classifier for the target object <p>If you selected the <none> entry, a simple Association is created and the target object is unclassified.</p>
Cancel	Cancel the dialog without changing any classifier settings.

Notes

- When creating a new association or object, the 'Properties' dialog might appear before the 'Choose an Association Connector' dialog; complete any 'Properties' fields as required, and click on the OK button

Behavior

Enterprise Architect enables you to define an element's behavior through the element's operations and parameters. You can also define the behavior of more specific behavioral elements such as Activities, Interactions, Actions and Interaction Occurrences, through the 'Behavior' tab of the Properties window.

Operations

Operations are features of a Class or other element that represent the behavior or services an element supports. For example, in a Customer Class, 'UpdateCustomerName' and 'GetCustomerAddress' can be operations. Operations have several important characteristics, such as type, visibility (scope), static, abstract and notes.

Access

Ribbon	Design > Element > Editors > Features > Operations
Context Menu	Right-click element in diagram or Browser window Features Operations or Right-click operation in Browser window Properties Properties ('Operation' dialog)
Keyboard Shortcuts	F10
Other	On a diagram, double-click on an operation ('Operation' dialog) In the 'Project' tab of the Browser

	window, double-click on an operation to locate and highlight the parent element in a diagram
--	--

Create and Modify Operations

You can create the operations of an element on the 'Operations' tab of the Features window, and modify the basic properties. You use the Properties window or 'Properties' dialog for operations to provide more detailed properties of the operations you need for an element.

Appearance on diagram

In diagrams, elements with operations (typically Classes) list the operations in a properties compartment, in colored text, as shown.

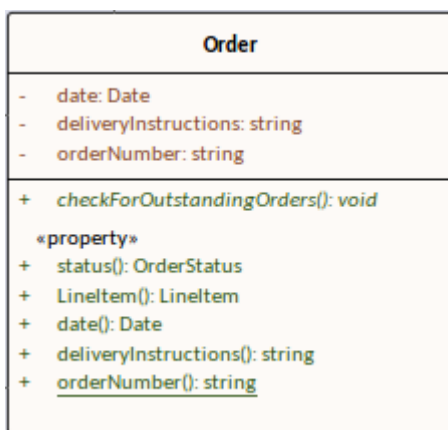

The text color can be defined on the 'Standard Colors' page of the 'Preferences' dialog. Some characteristics modify the display; for example, static operations display underlined,

whilst abstract operations are italicized.

Appearance in Browser Window

In the Browser window, operations are listed underneath their parent element name, each preceded by a pink box.

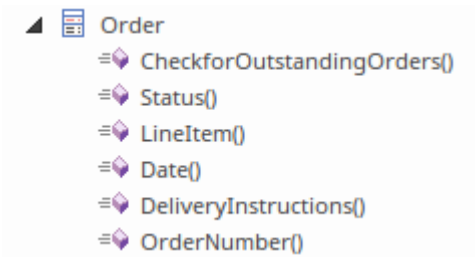

Notes

- If the parent element provides source or target roles for a connector, the connector can be attached to a specific operation
- You can also drag, copy or move existing operations between elements; this facility is only available if the target element supports operations

Define Properties of Operations

You create operations for an element on the 'Operations' page of the Features window, and provide a basic set of properties. You can simply create a number of operation names if you want to create operations quickly and not necessarily fully define them as you create them. You provide the more detailed properties of the operations using the operation 'Properties' dialog.

Operations of State elements are managed differently - there are three operations (Enter, Do and Exit) that are defined on the 'Behavior' tab of the Features window. This tab displays only when the selected element is a State. Similarly, if the element is a Database Table, the 'Operations' tab is replaced by a 'Constraints/Indexes' tab.

Access

Click on an operation in the Browser window or a diagram.

Ribbon	Design > Element > Editors > Features > Operations Design > Element > Editors > Element > Properties Dialog
Context Menu	Right-click on the parent element Features Operations or (Browser window) Right-click on the

	operation Properties Properties (Diagram) Right-click on the operation View Properties
Keyboard Shortcuts	F10

Create and define Operations ('Operations' tab, Features window)

Field/Button	Action
Name	Overtyping the <i>New Operation...</i> text to create a new operation, or clicking on the name to edit an existing operation.
Parameters	Lists the parameters that have been defined for this operation on the 'Parameters' tab of the 'Properties' dialog for the operation.
Return Type	Defaults to 'void'. To change this, overtype the field or click on the drop-down arrow and click on: <ul style="list-style-type: none"> The required data type returned by the operation, as defined by the code

	<p>language (data type), or</p> <ul style="list-style-type: none"> • '<none>' for no type (or you can type in a value manually if you prefer), or • 'Select Type' and browse for the appropriate operation classifier (you can add a new one if there are no classifiers that suit) <p>To add new code language data types that can be displayed in this list, see the <i>Data Types</i> topic.</p>
<p>Scope</p>	<p>Click on the drop-down arrow and select one of:</p> <ul style="list-style-type: none"> • Public • Protected • Private • Package
<p>Stereotype</p>	<p>(Optional) Define one or more stereotypes for the operation; either:</p> <ul style="list-style-type: none"> • Type a stereotype name, or • Click on the  button and select the stereotype from the 'Stereotypes for <object name>' dialog <p>If you select multiple stereotypes, they are listed on separate lines of the 'Stereotype' field.</p>

Alias	(Optional) Type an alternative name or reference for the operation.
-------	---

Context Menu options

Right-click on the 'Operations' tab of the Features window.

Option	Action
Add New	Add a new operation to the list, with default values in the dialog fields. Shortcut: Ctrl+N
Operation	On the 'Behavior' tab for a State element, opens the 'Operation' dialog to add the details of the selected behavior operation.
Copy as New	Copy a selected operation as a new operation. Provide a new name for the operation and click on the OK button. Shortcut: Ctrl+C
Properties	Display the 'Properties' dialog for a selected operation. The 'Operation' tab of the 'Properties' dialog has the same fields as the Properties window for operations.

Properties Window	<p>Display the Properties window for a selected operation.</p> <p>Shortcut: Ctrl+2</p>
Restore Sort Order	<p>If you have used the column header arrows to reorganize the sequence in which the operations are displayed, click on this option to redisplay them in the default sequence (alphabetical by name).</p>
Move up	<p>Move the selected operation one row up the list.</p> <p>Shortcut: Ctrl+Up Arrow</p>
Move down	<p>Move the selected operation one row down the list.</p> <p>Shortcut: Ctrl+Down Arrow</p>
Field Chooser	<p>Display the 'Field Chooser' dialog, which contains any column headings not currently applied to the page.</p> <p>Drag a column heading from the 'Field Chooser' into the preferred position in the row of column headings. You can also drag the column headings into a different sequence.</p> <p>To return a column heading to the 'Field Chooser', drag it out of the heading row.</p>

Enable Group Box	Show or hide the Group Box, in which you reorganize the list sequence of the operations according to one or more characteristics.
Toggle Filter Bar	Show or hide the Filter Bar, in which you type text strings that the data in the corresponding column must match in order to be listed.
Delete	Immediately delete the selected operation from the element. Shortcut: Ctrl+Del
Help	Display the Help topic pertinent to the current tab.

Operation Behavior

You can define the behavior of an operation in one of two ways:

- As behavior code to be inserted into an operation Body when that operation is generated to file
- As a reference to a behavior element, such as an Activity or Interaction, or to another operation

Creation of the behavior code is discussed in the *Behavior Code* Help topic.

You can also provide a text description consisting of pseudo-code, structured text or just abbreviated notes, which is used as a comment on the behavior code. You have the option of displaying either this text or the reference on each depiction of the parent element on a diagram. In this State element example, the entry operation applies the behavior of the ActivityComp Activity, whilst the exit behavior is described in simple text.

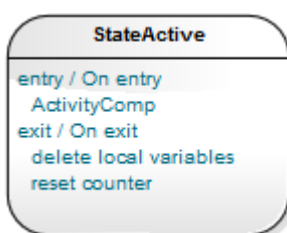

The operation Behavior is also applied during Interpreted Simulation and Executable StateMachine code generation and simulation, to provide 'entry/do/exit' behavior for States. In this case you create a short script in the 'Behavior' field, using JavaScript, to enact the operation behavior. For an example, access the EAExample Model and open 'Model

Simulation > StateMachine Models > Nested Traces > Example Class > Nested Traces', then open the 'Nested Traces' StateMachine diagram. Note the entry and exit scripts for each State. If you double-click on the 'entry' or 'exit' operations, the operation 'Properties' dialog opens and you will see the scripts in the 'Behavior' tab.

Access

In a diagram or the Browser window, click on an operation and then select one of the access methods identified here:

Ribbon	Design > Element > Editors Properties Dialog > Behavior
Context Menu	Properties Properties > Behavior
Keyboard Shortcuts	F10 > Behavior

Set Behavior

Either:

- In the 'Behavior' field, type the text or pseudo code description of the behavior, or
- Click on the Element button to display the 'Select Behavior' dialog, then browse for and select the

appropriate element or operation; when you click on the OK button, the fully qualified object name displays in the 'Behavior' field

If you want the behavior text or reference to be shown on any diagram that the operation appears in, select the 'Show Behavior in Diagram' checkbox.

If you want to use behavior code, click on the 'Code' tab and enter the code in the field on that tab.

When you have defined the operation behavior, click on the Save button.

Delete behavior

If you have typed in a behavior description in free text, simply select and delete the text.

If you have selected another behavioral object, click on the Element button and select the '<none>' option at the foot of the 'Select Element' hierarchy.

Example of Associated Behavior

An operation of, for example, a Class is being associated with a behavior elsewhere in the model. The operation is then set as the specification of that associated behavior. In code generation, the behavior of the associated behavioral element is generated as the operation's code; in this illustration, *opl* is associated with the Activity 'Activity'.

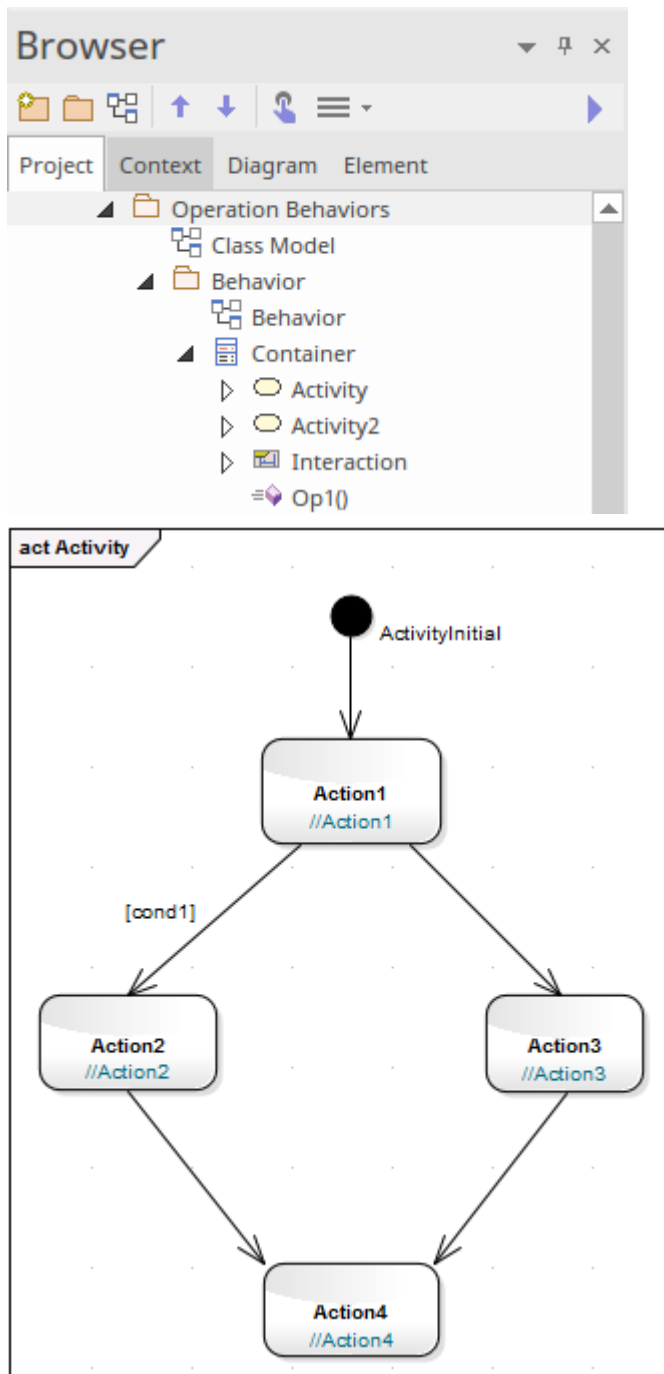

The generated code for *op1* is as shown:

```
package Behavior;  
public class Container {  
    public Container() {  
    }  
}
```

```
public void finalize() throws Throwable {
}
public void op1() {
/*Activity element(Activity)'s behavior rendered as
   operation(op1)'s code*/
    //Action1;
    if (cond1)
    {
        //Action2;
    }
    else
    {
        //Action3;
    }
    //Action4;
}
/*Activity element (Activity) not rendered*/
public void Activity2()
{
    // behavior is an Activity
}
public void Interaction()
{
    // behavior is an Interaction
}
```

} //end Container

Behavior Code

Behavior code is inserted into an operation Body when that operation is generated to file. This code is most useful when combined with Design Patterns; elements within a Pattern often require the same stub code. The behavior code is also useful for ensuring that the generated code can be directly compiled. The language-specific Patterns available from the web site resources include behavior code for some of the defined operations; this helps speed up the process of applying Patterns from model to implementation.

By default, the behavior code is not imported into the model during reverse engineering, but you can select to import the code by ticking the 'Include method bodies in model when reverse engineering' checkbox on the 'Source Code Engineering > Attribute/Operations' page of the 'Preferences' dialog.

You enter the behavior code through the Code Editor, which lists the operations within an element or within an Activity or StateMachine diagram and enables you to enter the behavior code for each operation individually. See the *Editing Source Code* Help topic.

On the Operation 'Properties' dialog, there is a 'Code' tab on which you can also enter the behavior code for the operation. The code editing facilities are more streamlined but you can use context menu options to paste copied code in from elsewhere. You can also click on the Code Editor button to, again, create the code in the Code Editor. Bear in mind that switching to the Code Editor closes the operation

'Properties' dialog and does not transfer incompletely saved code, so you should save any code you create in the 'Properties' dialog before making the switch.

The 'Properties' dialog also has a 'Behavior' tab on which you can type pseudo-code or plain text to state what the operation does. This text is added to the element code as a comment on the behavior code, and can be displayed on the parent element in a diagram. See the *Operation Behavior* Help topic.

Access

Before displaying the Behavior code, click on the required operation in the Browser window or a diagram.

Ribbon	Develop > Source Code > Behavior Design > Element > Behavior
Context menu	Right-click on operation Properties Properties > Code (if preferred, then : Code Editor)

Options

When selecting from the ribbon, you have three options for developing code:

- Edit Behavior

- Edit Internal Code
- Edit (or View) Source Code

All three options display the Code Editor window, but show the appropriate features, code and editing options for the type of code identified by the option. Within the Code Editor you can right-click on the Operation and select to switch from whichever aspect you are working on to one of the other two.

Redefine Operation and Check for Exceptions

If the parent element of a selected operation is the source element for a Generalize connector, you can configure the operation to redefine an operation in the target element. Also, you can create code in your application to check for an exception and, if one occurs, to switch to the code defined by a Classifier element. You can identify the target operation and/or the classifier element on the 'Redefines' tab of the Operation 'Properties' dialog.

It is also possible to add or change these properties in the 'Raised Exceptions' and 'Redefined Operation' fields of the Properties window for an operation.

Access

Context Menu	On an open diagram, click on an operation and then right-click View Properties > Redefines In the Browser window, right-click on an operation Properties Properties > Redefines
--------------	--

Tasks

Task	Action
Redefine a target element Operation	<ol style="list-style-type: none"> 1. Click on the Add button beneath the 'Redefined Operation' panel. The 'Select Operation' dialog displays, showing the operations in the target element. 2. Click on the appropriate operation; if you want to redefine more than one operation in the target element, press Ctrl as you click on each one. 3. Click on the OK button. A statement displays in the 'Redefined Operation' panel, of the format: <pre style="margin-left: 40px;"><Package>::<Target Element>.<Operation></pre> 4. On the parent element in a diagram, the Operation compartment shows the complete statement, of the format: <pre style="margin-left: 40px;"><Operation>: {redefines <Package>::<Target Element>.<Operation></pre> <p>If you want to change the redefined operation(s) at any point, return to the 'Redefines' tab and again click on the Add button, and repeat the process. The original selection is replaced by the new selection.</p>

	<p>You can also add or change a redefined operation (with a little more knowledge of your element structures) in the 'Redefined Operation' field of the Properties window for the operation.</p> <ol style="list-style-type: none"> 1. Click on the operation in a diagram or the Browser window, and press Ctrl+2. 2. In the Properties window, click on the  icon at the end of the 'Redefined Operation' field. The 'Redefined Operation' browser displays. 3. Locate and double-click on the required redefined operation. 4. In the Properties window, click off the 'Redefined Operation' field; the name of the selected operation displays in the field.
<p>Identify Exception Classifier</p>	<ol style="list-style-type: none"> 1. Click on the Add button beneath the 'Raised Exception' panel. The 'Select Classifier' dialog displays; locate and double-click on the appropriate Classifier. 2. The name of the parent Package and the Classifier displays in the 'Raised Exception' panel. <p>If you want to change the Classifier at any point, return to the 'Redefines' tab</p>

and 'Raised Exception' panel and again click on the Add button, repeating the process. The original selection is replaced by the new selection.

You can also add or change the Exception Classifier through the Properties window for the operation.

1. Click on the operation in a diagram or the Browser window, and press Ctrl+2.
2. In the Properties window, click on the  icon at the end of the 'Raised Exceptions' field.
The 'Raised Exceptions' browser displays.
3. Locate and double-click on the required classifier.
4. In the Properties window, click off the 'Raised Exceptions' field; the name of the selected classifier displays in the field.

Operation Constraints

Constraints define the contractual behavior of an operation, what must be true before they are called (pre-conditions) and what is true after they are called (post-conditions). In this respect they are related to the State model of a Class and can also relate to the guard conditions that apply to a transition. You can define both pre- and post- conditions for an operation.

Access

Before displaying the 'Properties' dialog, click on the required operation in a diagram or the Browser window.

Keyboard Shortcuts	(From the diagram) Enter > Pre or Post (From the Browser window) Enter Properties > Pre or Post
--------------------	--

Define Constraints

The fields and options on the 'Pre' and 'Post' tabs of the Properties window are identical. Click on the appropriate tab to define the conditions prior to and following on from the operation behavior.

Option	Action
--------	--------

Pre-Condition: Post-Condition:	Type in the name or effect of the condition.
Type	Click on the drop-down arrow and click on the appropriate condition type.
<notes>	Type in any further explanation or description that is necessary for the condition.
New	Click on this button to clear the fields to define another condition.
Save	Click on this button to save the new or updated condition and to add the changes to the 'Pre-Condition' or 'Post-Condition' list. This button also clears the data fields so that you can create another condition.
Pre-Condition Post-Condition	Lists the pre-conditions or post-conditions that have been defined for this operation. Click on an item in this list to re-populate the dialog fields with the details, to edit or delete the condition.

Delete	Click on an item in the 'Pre-Condition' or 'Post-Condition' list and click on this button to delete that condition from the operation.
--------	--

Operation Tagged Values

Both operations and the parameters assigned to operations can have Tagged Values associated with them. Tagged Values offer a convenient extension mechanism for UML objects, so you can define any tags you need and then assign values to them using this form.

Tagged Values are written to the XMI output, and can be input to other third party tools for code generation or other activities.

You can add and edit Tagged Values on an operation or parameter using either the:

- 'Tags' tab of the Properties window for the operation or
- 'Tagged Values' tab of the 'Properties' dialog for the operation

If the operation has any parameters, the parameter names and Tagged Values are listed on the 'Tagged Values' or 'Tags' tab underneath the Operation name and Tagged Values.

Access

Click on the operation in either a diagram or the Browser window.

Ribbon	Design > Element > Properties > General > Tagged Values (Properties window) Start > All Windows > Properties >
--------	--

	General > Tagged Values (Properties window)
Keyboard Shortcuts	Ctrl+2 > Tags (Properties window) (On a diagram) Enter > Tagged Values ('Properties' dialog) (In the Browser window) Enter Properties > Tagged Values ('Properties' dialog)

Add a Tagged Value for an operation or parameter

Step	Action
1	Click on the operation or parameter to which to assign the Tagged Value.
2	Click on the  button in the Toolbar at the top of the panel. The 'Tagged Value' dialog displays.
3	In the 'Tag' field, type the tag name (or select a defined tag from the drop-down list). In the 'Value' field type the initial tag value. (For

	some types of Tagged Value, the 'Value' field is grayed out. In this case, continue to step 4 and then enter the value against the tag value on either the 'Tags' tab of the Properties window or the 'Tagged Values' tab of the 'Properties' dialog.)
4	Click on the OK button to confirm the operation.

Notes

- Tagged Values are supported for attributes, operations, objects and connectors
- You can define custom tags using a predefined Tagged Value Type

Override Parent Operations

You can automatically override operations from parent Classes and from realized Interfaces, using the '**Overrides & Implementations**' dialog. You can configure the system to display this dialog each time you add a Generalization or Realization connector between Classes and Interfaces, and review their possible operations in classes and interfaces to override or implement.

Access

To display the dialog automatically, from the Start ribbon, select '**Appearance > Preferences > Preferences : Links**' and select the '**Show Override Operation dialog on new connector**' checkbox.

Ribbon	Design > Element > Manage > Overrides and Implementations
Keyboard Shortcuts	Ctrl+Shift+O

Using the dialog

Note: The information presented here applies equally to both base classes and interfaces, from which derived classes or realized interfaces are derived. To improve readability,

we will refer only to classes.

Select the checkbox against each operation in the base class that you wish to automatically override (or click on the Select All button);

If the selected operation has already been overridden by an operation in a derived class or realized interface through the use of the '**Enforce Synchronization**' option, then the column 'Enforce Synchronization' will display the value '**True**'. In this case, the checkbox '**Enforce Synchronization**' will be selected and will also be disabled (the option cannot be changed). Otherwise, you can select the option '**Enforce Synchronization**' to force synchronization of the operation signature to the overridden operation;

When you click on the OK button, Enterprise Architect generates the equivalent operation definitions in the derived class.

Notes

- If you select '**Enforce Synchronization**' when adding an overriding operation, then if the signature of the operation in the base class is subsequently modified, the corresponding operations in the derived class will also be modified, such that the operation signatures are '**synchronized**'.
- The signature of the operation in the derived class cannot be changed, but it can be deleted.

- If the operation in the base class is deleted, EA will prompt the user, asking whether to delete the corresponding operation in the derived class, or to delete the operation in the base class only.

Display Inherited Operations

You can configure a selected element in a diagram to display the complete operation set obtained from all ancestors in the element's type hierarchy, as well as those directly owned.

Access

Context Menu	Right-click element on diagram Compartment Visibility
Keyboard Shortcuts	Ctrl+Shift+Y

Enable Behavior

On the 'Compartment Visibility' dialog, in the 'Show Element Compartments' panel, select the 'Inherited Operations' checkbox.

Example

This diagram illustrates the behavior, where it has been enabled for each element in a simple hierarchy. The Child element inherits from all other levels of the hierarchy.

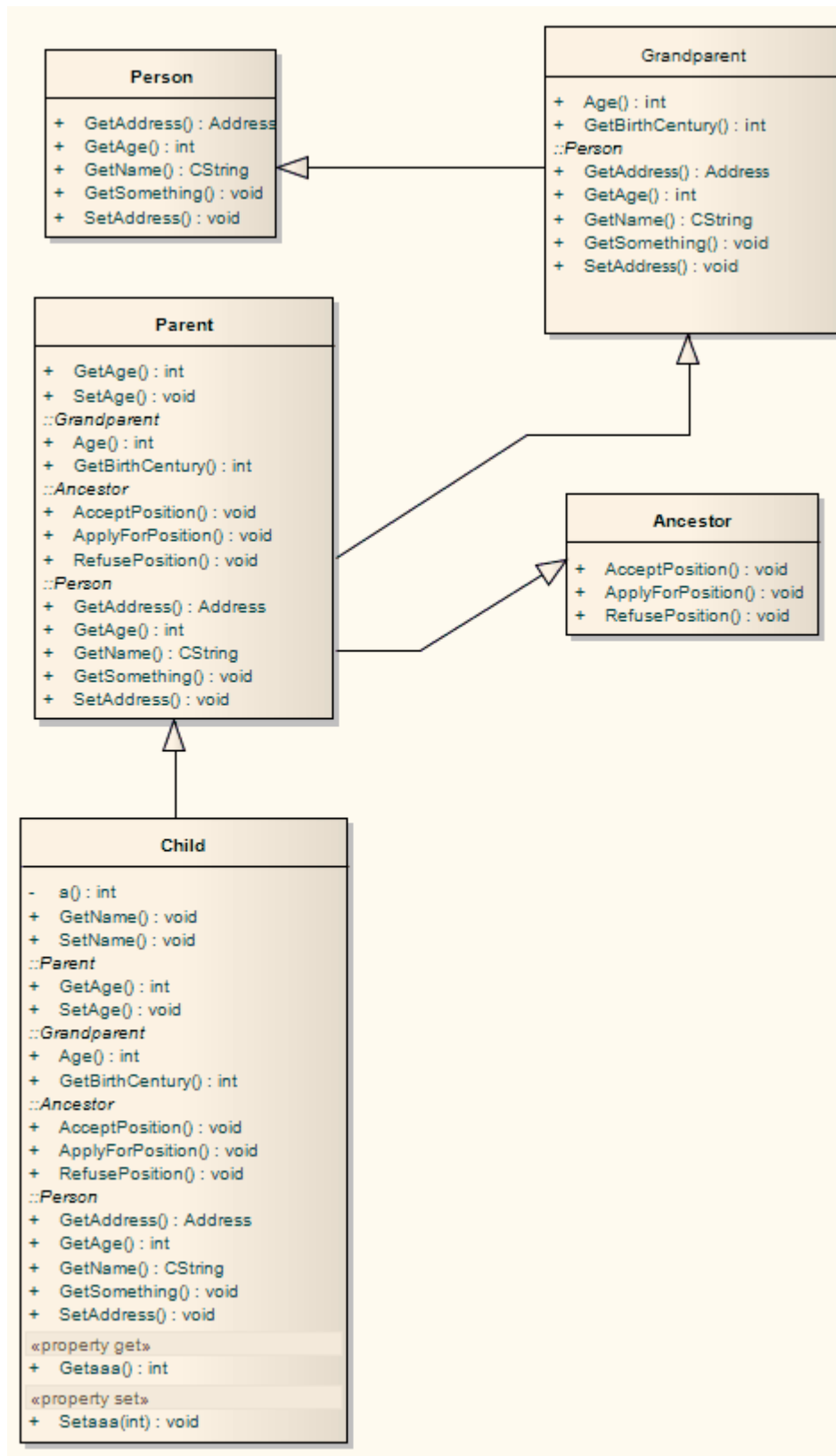

Behavior Parameters

The 'Parameters' tab of the 'Properties' dialog for an operation provides the facilities for defining, editing and extending the parameters of behavioral operations, Activities and Interactions.

Access

Ribbon	Design > Element > Editors > Properties > Click on the operation (diagram or Browser window) :  > Parameters
Context Menu	Right-click on operation (in diagram) View Properties > Parameters Right-click on operation (in Browser window) Properties Properties > Parameters

Define Parameters

Within the properties of an operation, Activity or Interaction, you can define parameters to control how that object and its subordinate objects behave.

The order or sequence of the parameters in the object properties is reproduced in code. You can set and manage the order using facilities available within the 'Parameters' tab of the 'Properties' dialog for an operation.

Access

Click on an operation in the Browser window or in a diagram.

Ribbon	Design > Element > Editors > Properties Dialog > [select or create an operation] > Parameters
Keyboard Shortcuts	F10 > Parameters

Define the Parameters

The first two fields are in the left-hand panel of the tab, and the remaining fields are in the right-hand panel.

Option	Action
--------	--------

Parameter	In the 'Parameter' list, overtype the <i>New Parameter</i> text with the new parameter name.
Type	<p>Click on the drop-down arrow and click on:</p> <ul style="list-style-type: none"> • The required data type of the operation, as defined by the code language (data type) or • <none> for no type (or you can type in a value manually if you prefer), or • 'Select Type' and browse for the appropriate operation classifier (you can add a new one if there are no classifiers that suit) <p>To add new code language data types that can be displayed in this list, see the <i>Data Types</i> Help topic.</p>
Default Value	(Optional) Type a default value for the parameter.
Stereotype	(Optional) Type in the appropriate stereotype name, or click on the  button and select one using the 'Stereotypes for <object name>'. You can select multiple stereotypes, in which case each stereotype is shown on a separate line of

	the 'Stereotype' field.
Alias	(Optional) Type an alternative name or reference for the parameter.
Direction	<p>Click on the drop-down arrow and select the way the parameter is passed to a function:</p> <ul style="list-style-type: none">• In = By Value• InOut = By Reference• Out = Passed By Reference, but only the return value is significant• Return = The parameter is a returned value
Fixed Value	Click on the drop-down arrow and select True, even if the parameter is passed by reference.
Multiplicity	<p>Click on the  button to display the 'Multiplicity' dialog, and define the multiplicity of the parameter.</p> <ul style="list-style-type: none">• Lower bound - Type the lower limit to the number of elements that must be in the collection• Upper bound - Type the upper limit to the number of elements allowed in the collection

	<ul style="list-style-type: none">• Allow Duplicates - Select the checkbox to indicate that duplicate values are allowed; this field maps to the UML property isUnique, with a value False• Multiplicity is Ordered - Select the checkbox to indicate that the collection is ordered• OK - Click on this button to save the information and close the dialog
Notes	Click on the  button and type any additional notes on the parameter. These notes are unformatted.

Notes

- To organize parameters into the required sequence, and reorganize the display of information, right-click on the background of the 'Parameter' tab or on a specific parameter and select from the same context menu options as for the 'Operations' tab
- Set the amount of parameter detail to display in a specific diagram using the 'Show Parameter Detail' drop-down list on the 'Features' tab of the 'Properties' dialog for the diagram; the setting applies only to the current diagram, and the default is to show the type only
- You can set Tagged Values on a parameter, as well as on

the parent operation

Parameter Tagged Values

Behavioral parameters of operations, Activities and Interactions can have Tagged Values associated with them. Tagged Values offer a convenient extension mechanism for UML elements; you can define any tags you need and then assign values to them.

Tagged Values are written to the XMI output, and can be input to other third party tools for code generation or other activities.

Access

Display the 'Tags' tab of the Properties window, using any of the methods outlined here. Then, in the Browser window or a diagram, select the object containing the parameter.

Ribbon	Start > All Windows > Properties > General > Tagged Values Design > Element > Properties > General > Tagged Values Explore > Portals > Windows > Properties > Tagged Values
Keyboard Shortcuts	Ctrl+2 > Tags

Add a Tagged Value for a parameter

Step	Action
1	<p>The 'Tags' tab shows the Tagged Values for the selected object and its parameters, under separate headings.</p> <p>Click on the required parameter in the 'Parameters' section, and click on the New Tags button.</p> <p>The 'Tagged Value' dialog displays.</p>
2	<p>In the 'Tag' field, type the tag name (or select a defined tag from the drop-down list).</p> <p>In the 'Value' field type the initial value of the tag. (Extended tags might not allow you to set a value through the 'Tagged Value' dialog; for such tags, enter the value on the 'Tags' panel of the Properties window.)</p>
3	<p>Click on the OK button to confirm the Tagged Value.</p>

Notes

- Tagged Values are supported for attributes, operations,

objects and connectors

- Custom tags can be created using a predefined Tagged Value Type

Operation Parameters by Reference

In your project, you can set operational parameters to be passed 'By Reference', as a global setting.

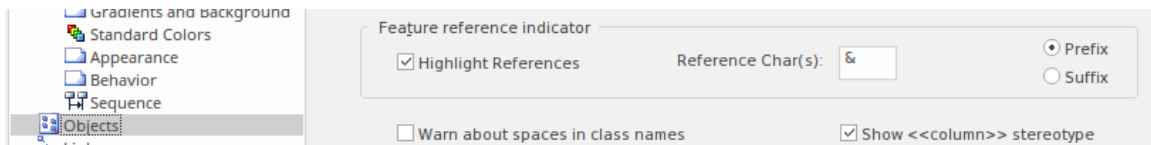

Access

Ribbon	Start > Appearance > Preferences > Preferences > Objects > Feature reference indicator
--------	--

Define Parameters

You can select to highlight parameters declared as 'Kind: inout' or 'Kind: out' with an additional user-defined prefix or suffix.

If you select the 'Highlight References' checkbox, you can also indicate whether a prefix or suffix should be used, and the actual reference character to use. In the example image, the '&' character has been set as a prefix.

When you declare a parameter of type 'inout', it is assumed you are passing the parameter by reference rather than by value. If you have elected to highlight references, then this

is displayed in the Diagram View.

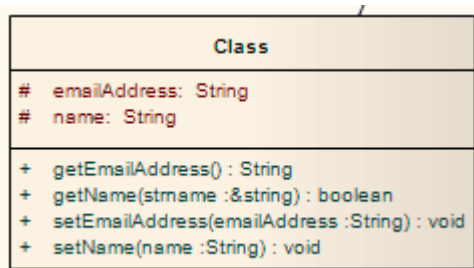

The example shows that, in the getName operation, the parameter 'strName' is a string reference, and is highlighted using the chosen character and position.

Notes

- This facility applies to operations only

Interactions and Activities

The behavioral aspects of Interactions and Activities are modeled using the 'Behavior' tab of the Properties window for the element, on which you assign parameters and return types to the elements.

Access

Select an Interaction or Activity element on a diagram or in the Browser window, then display the 'Behavior' tab of the Properties window, using any of the methods outlined here.

On the 'Behavior' tab, click on the  button of the 'Parameters' field to edit the element's parameters on the 'Parameters tab'. When you create a new parameter using the 'Parameters' tab, it internally creates an Activity Parameter Node for an Activity or an Interaction Parameter for an Interaction.

In the 'Return' field, click on the drop-down arrow and select the return type of the element. Alternatively, click on the  button and use the 'Select Type' dialog to locate the appropriate classifier.

The 'Specification' field is populated automatically when an operation is associated with the Activity or Interaction as a behavior.

Ribbon	Design > Element > Editors > Properties > Behavior

Keyboard Shortcuts	Ctrl+2 > Behavior
---------------------------	-----------------------------

Behavior Calls

A behavior call is the invocation of a behavior, which you can represent with a CallOperation Action (Operation), CallBehavior Action (Activity) or Interaction Occurrence (Interaction) element. You model the properties of the behavior call using the 'Behavior' tab of the Properties window for the Action or Interaction Occurrence element. You use behavior calls to:

- Edit Arguments
- Re-associate the call with a different behavior
- Synchronize the arguments with the parameters in the associated behavior

Access

Ribbon	Design > Element > Editors > Properties > Behavior Start > Application > Design > Properties > Behavior
Keyboard Shortcuts	Ctrl+2 > Behavior Alt+1 Properties > Behavior

Editing a Behavior Call

Click on the  button at the end of the 'Argument' field to display the 'Arguments' tab and create and delete arguments, relating each one to a corresponding parameter in the associated behavior.

Click on the  button on the 'Behavior' field to re-associate the invocation with a different behavior or to remove any association with the current behavior.

For Interaction Occurrence elements, an 'Interaction Occurrence' panel is displayed as well. It enables you to enter the return value and attribute of the behavior call.

Associate with Different Behaviors

On the 'Behavior' tab of the Properties window for the Behavior Call element, when you click on the 'Behavior' field  button the 'Select Element' or 'Select Operation' dialog displays, listing all available behaviors in the model. Select '<none>' to remove any existing association between an invocation and a behavior, or select another classifier to re-associate the invocation with a different behavior.

When a valid behavior is identified in the 'Behavior' field, the Synchronize with Parameters button is enabled for synchronizing the arguments with the parameters.

Access

Ribbon	Design > Element > Editors > Properties > Behavior Start > Application > Design > Properties > Behavior
Keyboard Shortcuts	Ctrl+2 > Behavior Alt+1 Properties > Behavior

Behavior Call Arguments

You define the arguments of a Behavior Call using the 'Arguments' tab of the Properties window for the element.

Access

Ribbon	Design > Element > Editors > Properties > Arguments Start > Application > Design > Properties > Arguments
Keyboard Shortcuts	Ctrl+2 > Arguments Alt+1 Properties > Arguments

Define the arguments of a Behavior Call

Step	Action
1	In the 'Name' field, type the name of an argument to map to the behavior.
2	In the 'Param' field, click on the drop-down arrow and select a behaviors parameter from the list of

	parameters associated with the behavior.
3	<p>In the 'Default' field, set any required default value. Optionally, you can also:</p> <ul style="list-style-type: none">• Assign a stereotype from the 'Stereotype' field drop-down list, or by browsing for one using the  button• Provide an alternative name or reference for the argument, in the 'Alias' field, and/or• Type in some notes to describe or explain the argument
4	<p>If a diagram is displayed, and if required, select the 'Show in current diagram' checkbox to add an Action Pin on the diagram to represent the argument.</p>
5	<p>Click on the Save button.</p>
6	<p>If appropriate, click on the New button and repeat steps 1 to 5 for another argument:parameter mapping.</p>

Notes

- If you attempt to map a newly created argument to a parameter that is already associated with a different argument, Enterprise Architect identifies the mapping and

prompts you to confirm that you intend to change the association

Synchronize Arguments

In your project, you can synchronize the parameters and arguments in a behavioral invocation.

On the 'Behavior' tab of the Properties window for the element, click on the Synchronize with Parameters button to synchronize the number of arguments in the invocation element with the number of parameters in the associated behavior.

This automatically creates or deletes arguments based on the number of parameters in the behavior.

If any arguments are to be deleted, Enterprise Architect prompts you to confirm the operation. Click on the Yes button to confirm.

Access

Ribbon	Start > Application > Design > Properties > Behavior Design > Element > Editors > Properties > Behavior
Keyboard Shortcuts	Ctrl+2 > Behavior Alt+1 Properties > Behavior

Notes

- The Synchronize with Parameters button is enabled only if the invocation is associated with a valid behavior, identified in the 'Behavior' field

Hyperlinks

Hyperlinks are very simple structures, but they add an incredible versatility to both navigation of your model and the provision of information through the various methods of communication within your project. You can create hyperlinks:

- As elements or references in diagrams
- In the text of notes and descriptions in the properties of modeling objects and project management objects
- In the element specifications in the Specification Manager
- In the text of Linked Documents or generated reports, through the document and template editors
- In Model Mails and Model Library postings

In each case, the targets of these hyperlinks might be:

- Packages, elements, diagrams, attributes or operations in the model
- Specific topics in the Enterprise Architect Help
- External files
- Web sites
- Model Library postings
- Diagram images and other graphics
- Commands to initiate operations and processes in Enterprise Architect
- Model Searches to run
- Matrix profiles to display



- Learning Center topics

Between any two contexts, the way in which you create the hyperlink and the range of objects you can link to might differ, but the common benefit is that you are providing a wealth of information on a specific point without overburdening:

- The object with a lot of text in one volume
- Yourself in having to re-create and maintain the information in every instance of its use
- Your readers with too much information at once

Table of Methods

Create a Hyperlink	Description
As an element on a diagram	<p>To create a Hyperlink element on a diagram and assign a target object to it, either:</p> <ul style="list-style-type: none"> • Drag the 'Hyperlink' icon onto the diagram from the 'Common' page of the Diagram Toolbox, or • Click on the icon in the 'UML Elements' Toolbar and then click on the diagram <p>You provide the text of the link directly on the diagram, then double-click on the element to display the element 'Hyperlink</p>

	<p>Details' dialog on which you identify the type of target object, the target itself and any other necessary properties of the link. Note that initially the link text is held in the 'Alias' field and can be edited there, but if you select certain types of target object (such as another diagram) the link text is read from the 'Notes' field and the 'Alias' field is disabled.</p> <p>After you have defined the target object, double-clicking on the element executes the link; to edit the element's properties, right-click on it and select the 'Properties' option. For most type of link, the element displays as shown here:</p> <p> Java Code File</p> <p>Certain types of link, however, have their own icon; for example, a Hyperlink element linking to a diagram or a link to a Help topic (.</p>
<p>On a diagram to another diagram</p>	<p>To create a link to another diagram on the current diagram:</p> <ol style="list-style-type: none"> 1. Drag the target diagram on to the current (host) diagram. The 'Select Type' dialog displays. 2. Select the 'Hyperlink' option and click on the OK button. <p>The final hyperlinked diagram should</p>

	<p>now have a link referencing the target diagram, resembling this:</p>  Location : Location <p>The link will open (in this case) the 'Location' diagram in the 'Location' Package. The target diagram name is written to the element 'Notes' field, and you can edit this field in the element properties to an alternative link text.</p> <p>A hyperlink to a diagram, whether created by this method or by dragging the 'Hyperlink' icon onto the diagram, has a different icon to the standard Hyperlink element icon, although in all other respects it is the same type of element.</p> <p>(If the hyperlink displays as a Sub Activity, select the 'Start > Application > Preferences > Preferences > Diagram > Behavior' ribbon option and deselect the 'Use Automatic SubActivities' checkbox.)</p>
<p>On a diagram to a file</p>	<p>To create a hyperlink on a diagram to an external file, simply click on the file in a file list (such as Windows Explorer) or on your Desktop and drag it onto the diagram.</p> <p>A short context menu displays with two options - 'Hyperlink' and 'Artifact'. Click on the 'Hyperlink' option to create the</p>

	<p>hyperlink on the diagram.</p> <p>The link is effective immediately, and you can right-click on it to add or change properties as necessary.</p> <p>Files of most types - including .sql and .ddl - are opened within the appropriate Enterprise Architect code editor.</p>
<p>On a diagram to a Script</p>	<p>You can create a hyperlink on a diagram to execute a script. Simply drag the required script from the Execution Analyzer window onto the diagram. A context menu displays, from which you select whether the script to be executed is a Build, Test, Run, Debug or Deploy script. The hyperlink is effective immediately; when you click on it, the script executes.</p>
<p>As an Action element on a diagram</p>	<p>Drag an Action element from the 'Activity' page of the Toolbox onto the diagram; a context menu displays (if not, hold Ctrl as you drag the Action onto the diagram).</p> <p>Select the 'Other' option; the 'New Action' dialog displays, with the 'Other' radio button selected.</p> <p>Click on the drop down arrow on the text field in the 'Select Kind' panel, and click</p>

	<p>on the 'Hyperlink' option.</p> <p>Click on the OK button; the Hyperlink Action element displays on the diagram.</p> <p>Right-click on the element and select the 'Advanced Set Hyperlink' menu option; the 'Hyperlink Details' dialog displays.</p> <p>Set the hyperlink's properties.</p>
From Notes to a specific element	<p>Within the text of the 'Notes' field of an object's 'Properties' dialog, or in the Notes window, you have three options for creating a hyperlink to another element:</p> <ul style="list-style-type: none">• Right-click on a highlighted text string and select the 'Create Link to Existing Element' option, to link to an element anywhere in the model• Right-click on a highlighted text string and select the 'Create New Element from Selection' option, to create a new element in the same Package and link to it; the name of the element is the highlighted text• Click on the 'Hyperlink' icon in the 'Notes' toolbar to display the in-text 'Hyperlink Details' dialog, select 'Element' in the 'Type' field, and select the existing element to link to; the element name forms the link text in the 'Notes' text, at the cursor position

<p>In Notes/Description text</p>	<p>In a 'Notes', 'Description' or similar text field, you can also click on the 'Hyperlink' icon in the 'Notes' toolbar to create links to a range of types of object other than 'Element'. You can use full paths or local (path substitution) paths, and you can either select or type the link text, or leave the text blank to use the link address as the text.</p>
<p>Within the Specification Manager</p>	<p>As you build the specification of an element and create Notes text to describe it, you can add hyperlinks to a wide range of target objects to support and enhance the specification. Highlight the link text, right-click on it and select the 'Create Hyperlink' option. The 'Hyperlink Details' dialog displays, on which you specify the target object type and the object itself.</p>
<p>In a report document</p>	<p>When you generate a report on a section of your model, the Document Generator either:</p> <ul style="list-style-type: none">• Activates any hyperlink in that part of the model and includes the linked object (generally a diagram image) in the report, or• Displays the hyperlink as a reference to

	<p>the linked object (most other links)</p> <p>You can, however, add other hyperlinks directly to either the generated report or the report template, to display material external to the model; namely a web page, Enterprise Architect Help topic, or a document file. To do this, you right-click on the appropriate point in the report and select the 'Insert Hyperlink' option; then specify the access path of the object to link to.</p>
<p>Within a Linked Document</p>	<p>When you have created a Linked Document for an element, you can add hyperlinks in the text of that document to other elements in the model, and to web pages, Help files, Model Searches and Model Library Forums. When you next open the Linked Document you can double-click on the hyperlink to open the linked files or to locate and highlight the object in the Browser window.</p> <p>To create a link to an element, you can simply drag the element from the Browser window into the document. Alternatively, right-click in the text and, for an element, select the 'Create Link to Existing Element' option or, for links to other objects, select the 'Create </p>

	Hyperlink' option.
In a Model Library post	The Model Library facility provides a number of options for creating links out of dragged objects or specifically providing link text and a link address within a document or post. The 'Resources' folder underneath a Model Library Post consists entirely of links you create to objects of relevance to the post.
In a Model Mail	<p>When you are using Model Mail to discuss a modeling object or supporting information, you can add a hyperlink to your text to open the object that you are discussing.</p> <p>A quick way to create a hyperlink is to select the modeling object in the Browser window, place the cursor at the appropriate position in your message text, click on the Insert Quick Link button and select the name of the modeling object. The hyperlink to the object is immediately created at the cursor position.</p> <p>If you need to search for the modeling object, or you want to link to a different type of target such as a file, Model Search or Model Library message, click</p>

on:

- The 'Hyperlink' icon in the toolbar or
- The Insert Quick Link button and select the 'Other' option

The 'Hyperlink Details' dialog displays.
Use this to create the required link.

Hyperlink Target Objects

Some of the hyperlink facilities in Enterprise Architect are filtered to create a link between two specific types of object. Other facilities, however, give you a choice of types of target object with minor variations in the information you provide to identify the target. The widest variety of target types is available from the:

- Element 'Hyperlink Details' dialog displayed when you create a Hyperlink element on a diagram, and
- In-text 'Hyperlink Details' dialog displayed when you create a hyperlink in the element Notes, either from the Notes Toolbar or in the Specification Manager

The in-text 'Hyperlink Details' dialog does not prompt for the link text, so you either highlight a word or phrase in the text to act as the link text before you create the hyperlink, or you allow the name or path of the linked object to become the link text.

Most hyperlinks can only be actioned within the diagram or element in which they are created, but links to diagram images and Image Manager images are also actioned within a generated report and actually show the linked image.

Identify Target Objects

This table provides instructions for specifying the target object of a hyperlink, for each of the available types of object, using either of the two 'Hyperlink Details' dialogs.

Link to	Action
An attribute	<p>In the 'Type' field, click on the drop-down arrow and click on 'Attribute'. The 'Set Attribute' browser displays, in which you locate and click on the required attribute. Click on the OK button to return to the 'Hyperlink Details' dialog, and again to create the hyperlink.</p> <p>If you activate the link, the attribute is highlighted in the Browser window.</p>
A source path	<p>In the 'Type' field click on the drop-down arrow and click on 'Browse for File'. A file browser opens, from which you select the source directory containing a number of files that the user might want to open. Click on the OK button to return to the 'Hyperlink Details' dialog, and again to create the hyperlink.</p> <p>If a user activates the link, a 'Locate File' dialog displays at the specified source directory, and the user can select any of the files in that directory to open within Enterprise Architect or a registered external application.</p>
An element image	<p>In the 'Type' field, click on the drop-down arrow and click on 'Element Image'. The</p>

	<p>'Select an Element' browser displays, in which you locate and click on the required image-stereotyped Artifact element.</p> <p>Click on the OK button to return to the 'Hyperlink Details' dialog, and again to create the hyperlink.</p> <p>If you activate the link, the element 'Properties' dialog opens. In a generated report, the element image displays instead of the link.</p>
A diagram	<p>In the 'Type' field, click on the drop-down arrow and click on 'Diagram'. The 'Select Classifier' browser displays, in which you locate and click on the required diagram. You can search for the diagram by name in a specific namespace in the model, or across the whole model.</p> <p>Click on the OK button to return to the 'Hyperlink Details' dialog, and again to create the hyperlink.</p> <p>If you activate the link, the diagram opens. In a generated report, an in-text link acts as a simple reference to the diagram.</p>
A diagram image	<p>In the 'Type' field, click on the drop-down arrow and click on 'Diagram Image'. The</p>

	<p>'Select Classifier' browser displays, in which you locate and click on the required diagram. You can search for the diagram by name in a specific namespace in the model, or across the whole model. Click on the OK button to return to the 'Hyperlink Details' dialog, and again to create the hyperlink.</p> <p>If you activate the link, the diagram opens. In a generated report, an image of the diagram displays instead of the link.</p>
An Enterprise Architect command	<p>In the 'Type' field, click on the drop-down arrow and click on 'EA Command'. In the unlabelled 'Address' field, click on the drop-down arrow and select the required command from the list. If the command is not part of the default set, click on the drop-down arrow in the second field and select the technology that provides the command. For some commands you might have to provide further parameters, in which case the  button displays; click on this button and complete the resulting dialog.</p> <p>Click on the OK button to create the hyperlink.</p> <p>If you activate the link, the system actions the command and displays the</p>

	resulting screen, dialog or message.
An element	<p>In the 'Type' field, click on the drop-down arrow and click on 'Element'. The 'Select Element' browser displays, in which you locate and click on the required element. Click on the OK button to return to the 'Hyperlink Details' dialog, and again to create the hyperlink.</p> <p>If you activate the link on a diagram, the element is highlighted in the Browser window.</p> <p>If you activate an in-text hyperlink, the system will act on the element according to its type, with the same result as if you double-click on the element in the Browser window. For example, if you click on the hyperlink to a Document Artifact element, the document, specification or matrix that the Artifact represents opens; if you click on a hyperlink to a Chart element, its 'Properties' dialog opens at the chart 'Source' page.</p> <p>When hovering over the hyperlink, the standard hyperlink element buttons will also be displayed, allowing you to display the 'Properties' dialog, find the element in diagrams, find the element in the Browser</p>

	<p>window, or open the Linked Document attached to the element.</p>
A file	<p>'File' is the default setting for the 'Type' field.</p> <p>In the 'Address' field, type or paste the file path and file name to access, or click on the  button to browse for the file. (If you click on the 'Type' drop-down arrow and select 'File', the browser displays automatically.)</p> <p>Click on the OK button to create the hyperlink.</p> <p>If you click on a link created through the in-text 'Hyperlink Details' dialog, the file opens in an editor. In the element 'Hyperlink Details' dialog you can specify whether the file will be opened for editing or just for viewing.</p>
A Help topic	<p>In the 'Type' field, click on the drop-down arrow and click on 'Help'. In the 'Address' field, type or copy the .htm file name of the Enterprise Architect Help topic to link to; for example, <i>add_a_legend.htm</i>. You can get this address by displaying the Help topic and copying the contents of the address field at the top of the screen.</p> <p>Click on the OK button to create the</p>

	<p>hyperlink.</p> <p>If you activate the link, the Help topic opens from the Sparx Systems website.</p>
<p>An Image Manager Image</p>	<p>In the 'Type' field, click on the drop-down arrow and click on 'Image Manager'. The 'Image Manager' dialog displays, in which you locate and click on the required image name.</p> <p>Click on the OK button to return to the 'Hyperlink Details' dialog, and again to create the hyperlink.</p> <p>If you activate the link, the View Image window displays, showing the selected image. In a generated report, the image is also displayed instead of the link.</p>
<p>A Learning Center topic</p>	<p>In the 'Type' field, click on the drop-down arrow and click on 'Learning Center'. The path of the default Learning Center topic (<i>Use the Learning Center</i>) displays in the 'Address' field. Click on the 'arrow-head' symbols in the path to display the contents of each child section and browse to the topic you want to link to.</p> <p>Click on the OK button to create the hyperlink.</p> <p>If you activate the link, the Learning Center view opens, displaying the topic.</p>

<p>A Relationship Matrix profile</p>	<p>In the 'Type' field, click on the drop-down arrow and click on 'Matrix'. The 'Select a Matrix Profile' dialog displays; click on the drop-down arrow and on the required profile name.</p> <p>Click on the OK button to return to the 'Hyperlink Details' dialog, and again to create the hyperlink.</p> <p>If you activate the link, the Relationship Matrix displays with all fields set according to the selected profile.</p>
<p>An Operation</p>	<p>In the 'Type' field, click on the drop-down arrow and click on 'Operation'. The 'Set Operation' browser displays, in which you locate and click on the required operation.</p> <p>Click on the OK button to return to the 'Hyperlink Details' dialog, and again to create the hyperlink.</p> <p>If you activate the link, the operation is highlighted in the Browser window.</p>
<p>A Package</p>	<p>In the 'Type' field, click on the drop-down arrow and click on 'Package'. The 'Find Package' browser displays, in which you locate and click on the required Package.</p> <p>Click on the OK button to return to the</p>

	<p>'Hyperlink Details' dialog, and again to create the hyperlink.</p> <p>If you activate the link, the Package is highlighted in the Browser window.</p>
A Model Search	<p>In the 'Type' field, click on the drop-down arrow and click on 'Search'. The 'Select a Search' dialog displays, in which you specify the search term, the search category that contains the search, and the name of the search itself.</p> <p>Click on the OK button to return to the 'Hyperlink Details' dialog, and again to create the hyperlink.</p> <p>If you activate the link, the Find in Project view displays with the results of the executed search.</p>
A Simulation	<p>In the 'Type' field, click on the drop-down arrow and click on 'SimRun'.</p> <p>Click on the OK button to create the hyperlink.</p> <p>If you activate the link, a suite of Simulation windows display, and a simulation is executed on the current diagram.</p>
A Model Library	<p>In the 'Type' field, click on the drop-down arrow and click on 'Team Document'. The</p>

Posting	<p>'Select a Topic to Link' browser displays, in which you locate and click on the required review document.</p> <p>Click on the OK button to return to the 'Hyperlink Details' dialog, and again to create the hyperlink.</p> <p>If you activate the link, the Team Document view displays, showing the Linked Document. The Library window also displays, showing where the document came from and providing the opportunity to select and display related documents.</p>
A web site	<p>In the 'Type' field, click on the drop-down arrow and click on 'Web Site'. In the 'Address' field, type or paste the web address of the site.</p> <p>Click on the OK button to create the hyperlink.</p> <p>If you activate the link, the selected web page displays in a separate window.</p>

Notes

- To activate a Hyperlink element, double-click on it; to activate an in-text link, press Ctrl as you click on it

- When creating a hyperlink, for most target objects the system automatically opens a browser to populate the 'Address' field; when you edit the hyperlink, use the  icon at the end of the field to display the browser and change the target object

In-place Editing Options

This topic explores the tasks that can be performed using in-place editing of elements on a diagram in Enterprise Architect. The tasks include:

- [In-place Editing Tasks](#)
- [Edit Element Item Name](#)
- [Edit Feature Stereotype](#)
- [Edit Feature Scope](#)
- [Edit Attribute Keyword](#)
- [Edit Operation Parameter Keyword](#)
- [Insert Operation Parameter](#)
- [Edit Parameter Kind](#)
- [Edit Custom Compartment](#)
- [Insert New Feature](#) (Attribute or Operation)
- [Insert Maintenance Feature](#)
- [Insert Project Features](#)
- [Insert Testing Features](#)
- [In-place Editing Tasks](#)

In-place Editing Tasks

This topic explains how to edit and work with some properties of an element directly in the diagram.

Use In-place Editing Options

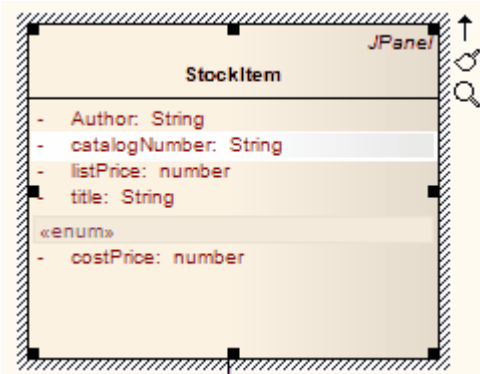
Step	Action
	<p>Open the diagram containing the element.</p>
	<p>Click on the element, and on the item to manipulate within the element.</p> <p>The item line is highlighted in a lighter shade (the default is white), to indicate that it has been selected.</p> 
	<p>Edit and manipulate the items in the element, either by pressing the appropriate keyboard keys or by right-clicking on the highlighted item and choosing a task from the 'Element Items'</p>

	<p>context menu.</p> <p>The available commands are listed in this table. Not all options are available for every type of item.</p>
--	--

Options

Menu option...	Action
Extensions	Display a submenu of extension products; click on one to display a further menu of operations to perform within the selected product.
Edit Selected	Change the name, scope or stereotype of the element or element item. Shortcut: F2
Insert New After Selected	Insert a new item in the element. Shortcut: Insert key
View Properties	Display the dialog containing details of the element. Shortcut: Enter key

Find in Project Browser	Locate the item in the Browser window.
Open in Specification Manager	If the element is a Package element, and the selected item is a subPackage, you can select this option to open and edit the subPackage in the Specification Manager.
Add Attribute	Add an attribute to the element. Shortcut: Ctrl+Shift+F9
Add Operation	Add an operation to the element. Shortcut: Ctrl+Shift+F10
Add Other	Insert a feature on the specific element item, such as Maintenance features and Testing features. Shortcut: Ctrl+F11
Delete Selected from Model	Delete the selected item from the model. Shortcut: Delete key
View Source code	Display the source code for the element, in the default external editor. Shortcut: F12

Visual Analyzer	Set a breakpoint on a highlighted operation (including a breakpoint, start recording marker, end recording marker or stack auto-capture marker.)
Set Type	Set a classifier type for the selected item. Shortcut: Ctrl+L
Navigate Diagram Selection	Navigate the diagram between elements without having to use the mouse. Shortcut: Ctrl+Shift+arrow
Highlight Element	Toggle element highlight option on and off. Shortcut: Shift+Enter

Keys

Other keyboard options that are available while editing element attributes or operations in a diagram include:

Shortcut	Description
Enter key	Accept current changes.
Ctrl+Enter	Accept current changes and open a new slot to add a new item.

Esc	Abort the edit, without save.
Tab key or Shift+Tab	Move the cursor between segments of a feature definition.
Shift+F10	Display the context menu for in-place editing.
Ctrl+Shift+Space	Invoke the 'Select <Item>' dialog.
Ctrl+Space	Display an autocompletion list for a feature classifier.

Notes

- Where an in-place editing menu command has a keyboard alternative, if the selected item happens to be off-screen when you press the keys, the diagram automatically scrolls to show the whole element, so that you can see what you are changing

Edit Element Item Name

You can edit the name of an element, operation or attribute directly on the diagram using in-place editing.

Edit element or feature name

Step	Action
1	Open the diagram containing the element.
2	<p>Click on the element and on the name to change within the element.</p> <p>The item line is highlighted in a lighter shade (the default is white), to indicate that it has been selected.</p> 
3	<p>Right-click on the item.</p> <p>The context menu displays.</p>
4	Select the 'Edit Selected' menu option, or press F2 to enable you to edit the item

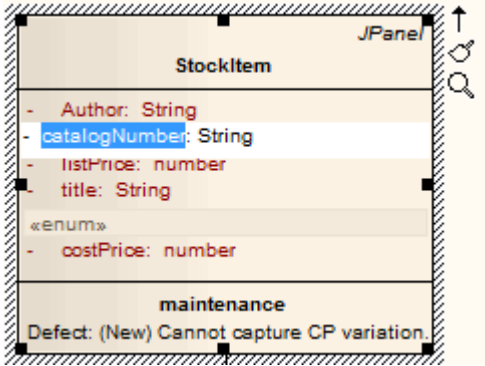
	<p>directly from the diagram. The name of the attribute or operation is highlighted.</p>
<p>5</p>	<p>Delete or type over the name.</p> 
<p>6</p>	<p>Press the Enter key to accept the change, or Esc to cancel the change.</p>

Edit Feature Stereotype

You can use in-place editing to edit a feature stereotype directly on a diagram.

Change the stereotype of an operation or attribute

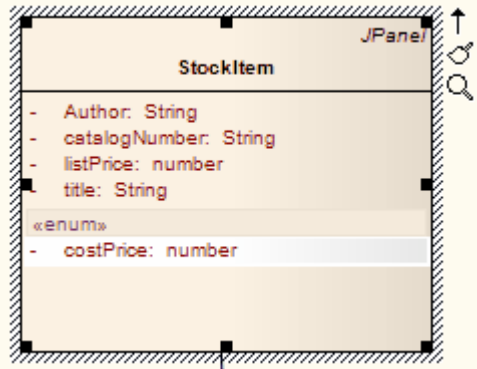
Step	Action
	<p>Open the diagram containing the element.</p>
	<p>Click on the element, and on the item to edit within the element.</p> <p>The item line is highlighted in a lighter shade (the default is white), to indicate that it has been selected.</p>  <p>The diagram shows a class named 'StockItem' with the following attributes: Author: String, catalogNumber: String, listPrice: number, title: String, and an enumeration «enum» with attribute costPrice: number. The 'costPrice' attribute line is highlighted in white. The class is contained within a 'JPanel' container, indicated by the label 'JPanel' and a magnifying glass icon on the right side of the diagram.</p>
	<p>Right-click on the item.</p> <p>The context menu displays.</p>

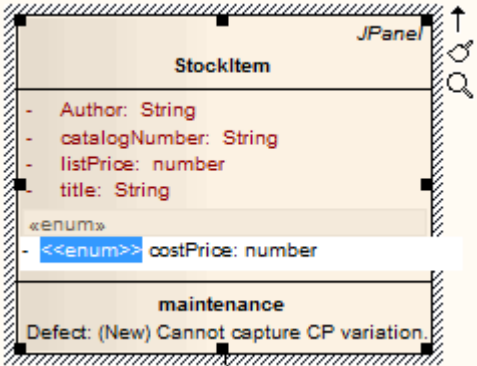
	<p>Select the 'Edit Selected' menu option (or press F2) to enable you to edit the attribute or operation directly from the diagram.</p> <p>The name of the item is highlighted.</p>
	<p>Move the cursor to the position before the name or within the existing attribute or operation stereotype (denoted by «stereotype name»).</p>  <p>The diagram shows a class named 'StockItem' with a 'JPanel' editor. The class has several attributes: 'Author: String', 'catalogNumber: String', 'listPrice: number', and 'title: String'. Below these is an enumeration attribute: '«enum» - <<enum>> costPrice: number'. The '«enum>>' part of this attribute is highlighted in blue. Below the enumeration is a 'maintenance' section with the text 'Defect: (New) Cannot capture CP variation.' A mouse cursor is positioned over the '«enum>>' text.</p>
	<p>Delete or type over the previous name to change the stereotype name of the attribute or operation.</p>
	<p>Press the Enter key to accept the change or Esc to cancel the change.</p>

Notes

- You can assign multiple stereotypes by including a

comma-separated list inside the stereotype markers

Edit Feature Scope

You can rapidly edit the scope of an attribute or operation directly on a diagram, using in-place editing.

Change the scope of a feature

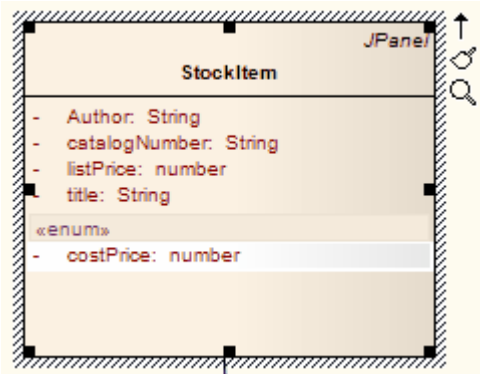
Step	Action
	<p>Open the diagram containing the element.</p>
	<p>Click on the element and on the item to edit within the element.</p> <p>The item line is highlighted in a lighter shade (the default is white), to indicate that it has been selected.</p>  <p>The diagram shows a class named 'StockItem' within a 'JPanel' container. The class has the following attributes: 'Author: String', 'catalogNumber: String', 'listPrice: number', and 'title: String'. Below these is an enumeration section labeled '<enum>' with the attribute 'costPrice: number'. The 'costPrice' attribute line is highlighted in a lighter shade, indicating it is selected. A context menu is visible on the right side of the diagram, with an upward arrow and a magnifying glass icon.</p>
	<p>Right-click on the item.</p> <p>The context menu displays.</p>
	<p>Select the 'Edit Selected' menu option (or press F2) to enable you to edit the</p>

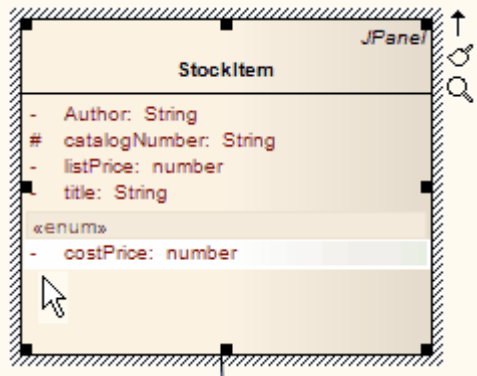
	<p>attribute or operation directly from the diagram.</p> <p>The name of the item is highlighted.</p>
	<p>Move the cursor to the scope of the item and delete the previous entry.</p> 
	<p>Reassign the entry by typing in one of these symbols:</p> <ul style="list-style-type: none">• + indicates that the scope is Public• - indicates that the scope is Private• ~ indicates that the scope is Package• # indicates that the scope is Protected
	<p>Press the Enter key to save the change, or Esc to cancel the change.</p> <p>The diagram is updated to reflect the changes (also see the catalogNumber attribute in the screen illustrations).</p>

Edit Attribute Keyword

You can add features such as attribute keywords and classifiers directly to an element, using the Element Keywords and Classifiers menu. This enables you to rapidly assign details element item by element item, directly from a diagram.

Add Features directly to an element

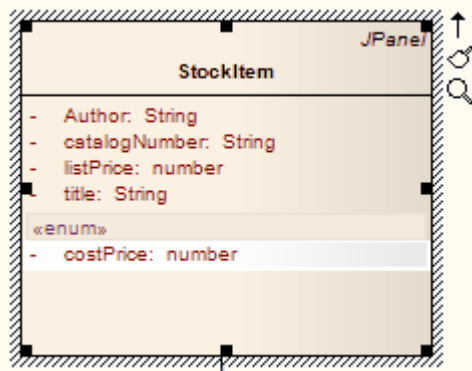
Step	Action
	<p>In Enterprise Architect, open the diagram containing the element.</p>
	<p>Click on the element, and on the attribute to edit within the element.</p> <p>The item line is highlighted in a lighter shade (the default is white), to indicate that it has been selected.</p>  <p>The screenshot shows a UML class diagram for 'StockItem' inside a 'JPanel' container. The class has several attributes: 'Author: String', 'catalogNumber: String', 'listPrice: number', and 'title: String'. Below these is an enumeration '«enum»' with the attribute 'costPrice: number'. The 'costPrice: number' line is highlighted in white, indicating it is selected.</p>
	<p>Right-click on the item.</p>

	The context menu displays.
	Select the 'Edit Selected' menu option (or press F2) to enable you to edit the attribute directly from the diagram. The name of the attribute is highlighted.
	Right-click on the attribute name to display the context menu.
	<p>From the context menu, you can:</p> <ul style="list-style-type: none">• Change the attribute classifier to static or fixed - select the 'static' or 'fixed' menu options as appropriate; the diagram is updated to reflect the changes• Display the Class properties - click on the 'Goto Definition' menu option; Enterprise Architect locates the Class in the Browser window and opens its 'Properties' dialog <p>If the data type is a raw data type, Enterprise Architect displays the message: <i>The data type is a raw data type.</i></p>

Edit Operation Parameter Keyword

You can directly edit operation classifiers by element, using the in-place editing menu. This enables you to rapidly assign parameter keywords.

Directly edit operation classifiers by element

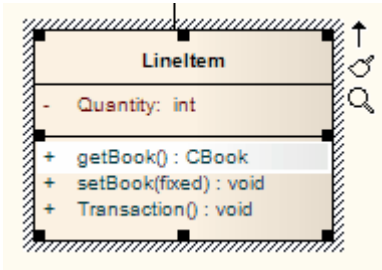
Step	Action
	<p>Open the diagram containing the element.</p>
	<p>Click on the element, and on the operation to edit within the element.</p> <p>The item line is highlighted in a lighter shade (the default is white), to indicate that it has been selected.</p>  <p>The diagram shows a class named 'Lineltem' with a private attribute '- Quantity: int' and three public operations: '+ getBook(): CBook', '+ setBook(fixed): void', and '+ Transaction(): void'. The 'setBook(fixed): void' operation is highlighted with a white background, indicating it is selected. To the right of the class box, there are three icons: an upward-pointing arrow, a magnifying glass, and a circular arrow, representing navigation and search options.</p>
	<p>Right-click on the item.</p> <p>The context menu displays.</p>
	<p>Select the 'Edit Selected' menu option (or press F2) to enable you to edit the</p>

	<p>operation directly from the diagram. The name of the operation is highlighted.</p>
	<p>Right-click on the data type of a parameter to display the context menu.</p>
	<p>From the context menu you can:</p> <ul style="list-style-type: none">• Change the operation classifier by clicking on the appropriate menu option - 'static', 'isquery', 'abstract' or 'fixed'; the diagram is updated to reflect the changes• Display the Class properties - click on the 'Goto Definition' menu option <p>If the data type is 'Class', Enterprise Architect locates the Class in the Browser window and opens its 'Properties' dialog</p> <p>If the data type is a raw data type, Enterprise Architect displays the message <i>This data type is a raw data type</i></p> <p>If the data type is not defined in the model, the message is: <i>The data type is not defined in the model</i></p>

Edit Parameter Kind

You can edit operation parameter kinds such as (in), (inout) and (out) directly from a diagram, element by element, using the Element Keywords and Classifiers menu. This enables you to rapidly assign the parameter directly from a diagram.

Edit operation parameter kinds directly from a diagram

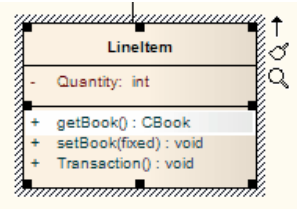
Images	Action
	<ol style="list-style-type: none"> 1. In Enterprise Architect, open the diagram containing the element.
	<ol style="list-style-type: none"> 2. Click on the element, and on the operation to edit within the element. The item line is highlighted in a lighter shade (the default is white), to indicate that it has been selected.
	<ol style="list-style-type: none"> 3. Right-click on the item. The context menu displays.
	<ol style="list-style-type: none"> 4. Select the 'Edit Selected' menu option (or press F2) to enable you to edit the

	<p>item directly from the diagram. The name of the item is highlighted.</p>
	<p>5. Right-click on the item name to display the context menu.</p>
	<p>6. Select the appropriate menu option for the parameter kind value: (in), (inout) and (out). The diagram is updated to reflect the change.</p>

Edit Custom Compartment

Items listed within a Custom Compartment can also be in-place edited. They have a similar in-place editing menu as other compartment items such as Operations and Attributes within a Class.

For example: a SysML Block element can have a Parts custom compartment. In-place editing can be performed upon the Parts listed within this compartment.

In-place edit an item in a Custom Compartment

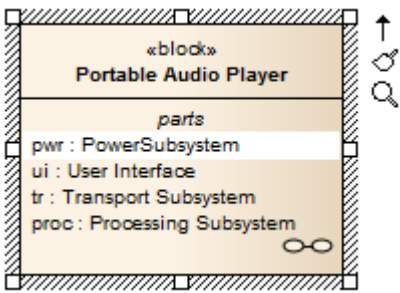
Step	Action
1	Open the diagram containing the element.
2	<p>Click on the element and on the item to change within the custom compartment.</p> <p>The item line is highlighted in a lighter shade (the default is white), to indicate that it has been selected.</p>  <p>The diagram shows a SysML Block Definition Diagram for a block named 'Portable Audio Player'. The block has a 'parts' compartment containing four items: 'pwr : PowerSubsystem', 'ui : User Interface', 'tr : Transport Subsystem', and 'proc : Processing Subsystem'. The 'ui : User Interface' item is highlighted with a lighter background, indicating it is selected. A mouse cursor is positioned over the 'ui' item, and a search icon is visible to the right of the block. The block itself has a search icon and a zoom icon in the top right corner.</p>

3	Right-click on the item. The context menu displays.
4	Select the 'Edit Selected' menu option, or press F2 to enable you to edit the item directly from the diagram. The name of the item is highlighted.
5	Delete or type over the name.
6	Press the Enter key to accept the change, or Esc to cancel the change.

Notes

- Custom Compartments such as Parts and Ports within a SysML Block also provide a Set Type command on the right-click menu to set the classifier type of the selected item.

Insert New Feature

You can insert a new element feature directly on a diagram, using in-place editing.

Add attributes and operations to a Class diagram element

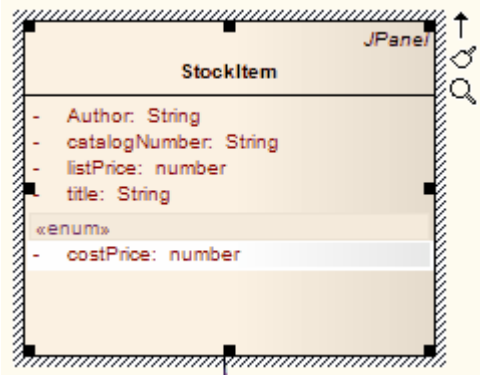
Step	Action
	<p>In Enterprise Architect, open the diagram containing the element.</p>
	<p>Click on the element and, within the element, on the item after which to insert the operation or attribute.</p> <p>The item line is highlighted in a lighter shade (the default is white), to indicate that it has been selected.</p> 
	<p>Either press the Insert key or right-click on the selected element item to display</p>

	<p>the context menu, and select the 'Insert New After Selected' menu option</p> <p>Enterprise Architect inserts a new data line in the diagram, underneath the selected item.</p>
	<p>Type in the relevant information for the attribute or operation.</p> <p>Use the Tab key and Tab+Shift keys to move the cursor through the segments of the attribute or operation, and select the classifier from either the:</p> <ul style="list-style-type: none">• Autocompletion list (press the Ctrl+Space keys) or• Select <Item> dialog (press the Ctrl+Shift+Space keys)
	<p>Press the Enter key to accept the change or Esc to cancel the change.</p> <p>The diagram is updated to reflect the changes.</p>

Insert Operation Parameter

You can add operation parameters to an operation through the in-place editing options, using hotkey commands or menu shortcuts.

Add parameters to operations in a Class diagram element

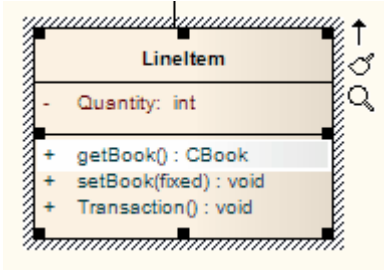
Step	Action
	Open the diagram containing the element.
	<p>Click on the element, and on the operation to update within the element. The item line is highlighted in a lighter shade (the default is white), to indicate that it has been selected.</p>  <p>The screenshot shows a UML class diagram element for 'LineItem'. The class has a private attribute '- Quantity: int' and three public operations: '+ getBook(): CBook', '+ setBook(fixed): void', and '+ Transaction(): void'. The operation '+ setBook(fixed): void' is highlighted with a lighter background, indicating it is selected. A mouse cursor is visible over the operation name.</p>
	Press F2, or right-click on the selected item and select the 'Edit Selected' option.
	Move the cursor inside the parameter

	<p>brackets and type the parameter name, followed by a colon (for example, bks: for a vector containing books).</p>
	<p>Give the parameter a type.</p> <p>Place the cursor after the colon at the end of the name and add the classifier; either:</p> <ul style="list-style-type: none">• Press Ctrl+Space to invoke the classifier autocompletion list• Press Ctrl+Shift+Space to select a classifier from the 'Select <Item>' dialog or• Click the right mouse button to display the inline editing options context menu and select the 'Insert Classifier' option <p>The 'Select <Item>' dialog displays.</p>
	<p>Press the Enter key to accept the change or Esc to cancel the change.</p> <p>The diagram is updated to reflect the changes.</p>

Insert Maintenance Feature

You can quickly insert a new maintenance item directly on a diagram, using in-place editing.

Assign maintenance details directly to an element from a diagram

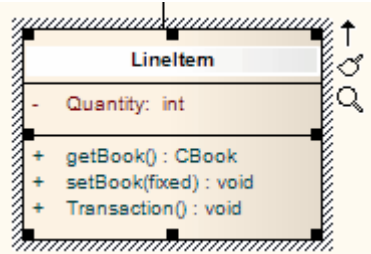
Step	Action
	Open the diagram containing the element.
	<p>Click on the element name.</p> <p>The name is highlighted in a lighter shade (the default is white), to indicate that it has been selected.</p> 
	<p>Either press Ctrl+F11 or right-click on the highlighted name and select the 'Add Other' option.</p> <p>The 'Insert Feature' dialog displays.</p>
	Click on the appropriate radio button

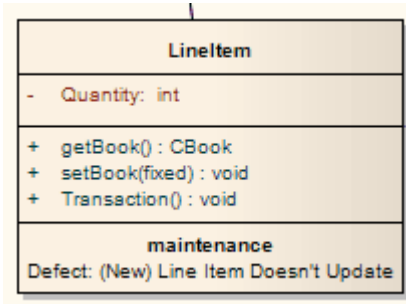
	<p>option to associate the required maintenance feature with the element item.</p>
	<p>Click on the OK button. The '<Maintenance Feature> details for <element>' dialog displays.</p>
	<p>Complete the fields to define the maintenance activity, and then click on the Apply button. To create a subsequent maintenance activity of this type, click on the New button.</p>
	<p>When you have defined all of the maintenance activities of this type, click on the OK button. The maintenance details are added to the element.</p>  <pre> classDiagram class LinelItem { - Quantity: int + getBook() : CBook + setBook(fixed) : void + Transaction() : void } LinelItem --> "maintenance" LinelItem --> "Defect: (New) Line Item Doesn't Update" </pre>

Notes

- To ensure that the maintenance items are visible in the diagram element, as shown in step 7, select the 'Maintenance' checkbox on the 'Elements' tab of the 'Properties' dialog for the diagram

Insert Project Features

You can quickly insert a new project item directly into a diagram, using in-place editing.

Assign project details directly to an element from a diagram

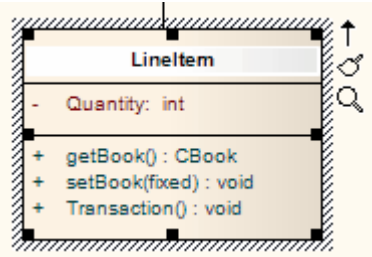
Step	Action
	<p>Open the diagram containing the element.</p>
	<p>Click on the element name.</p> <p>The name is highlighted in a lighter shade (the default is white), to indicate that it has been selected.</p>  <p>The screenshot shows a UML class diagram element named 'LineItem'. The name 'LineItem' is highlighted in a light grey box. Below the name, there is a private attribute '- Quantity: int'. Below the attribute, there are three public methods: '+ getBook(): CBook', '+ setBook(fixed): void', and '+ Transaction(): void'. The diagram is enclosed in a dashed border with a hatched background. On the right side, there are three small icons: an upward arrow, a magnifying glass, and a search icon.</p>
	<p>Either press Ctrl+F11 or right-click on the highlighted name and select the 'Add Other' option.</p> <p>The 'Insert Feature' dialog displays.</p>
	<p>Click on the appropriate radio button to</p>

	associate the required project feature with the element item.
	<p>Click on the OK button.</p> <p>The '<Project Feature> details for <element>' dialog displays for a Decision or Event item.</p> <p>The '<Project Feature>' dialog displays for a Risk, Metric or Effort item.</p>
	<p>For Decision and Event items:</p> <ul style="list-style-type: none">• Complete the fields to define the project activity, and then click on the Apply button• If creating a subsequent project activity of this type, click on the New button
	<p>When you have defined all of the project activities of this type, click on the OK button.</p> <p>The project details are added to the element.</p>

Notes

- To ensure that the project items are visible in the diagram element, as shown in step 7, select the 'Project' checkbox

on the 'Elements' tab of the 'Properties' dialog for the diagram

Insert Testing Features

You can add test records such as Unit, Integration, System, Acceptance, Inspection and Scenario tests directly to an element displayed on a diagram.

Add testing features to an element directly from a diagram

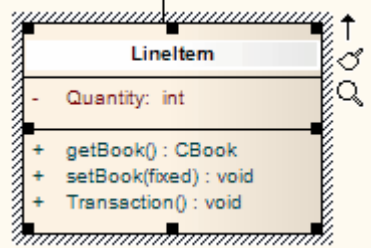
Step	Action
	<p>Open the diagram containing the element.</p>
	<p>Click on the element.</p> <p>The element name is highlighted in a lighter shade (the default is white), to indicate that it has been selected.</p>  <p>The image shows a UML class diagram for a class named 'LineItem'. The class name 'LineItem' is highlighted in a light grey box. Below the name, there is a private attribute '- Quantity: int'. Below the attribute, there are three public methods: '+ getBook() : CBook', '+ setBook(fixed) : void', and '+ Transaction() : void'. To the right of the class box, there are two icons: a magnifying glass and an upward-pointing arrow.</p>
	<p>Either press Ctrl+F11 or right-click on the highlighted name and select the 'Add Other' option</p> <p>The 'Insert Feature' dialog displays.</p>

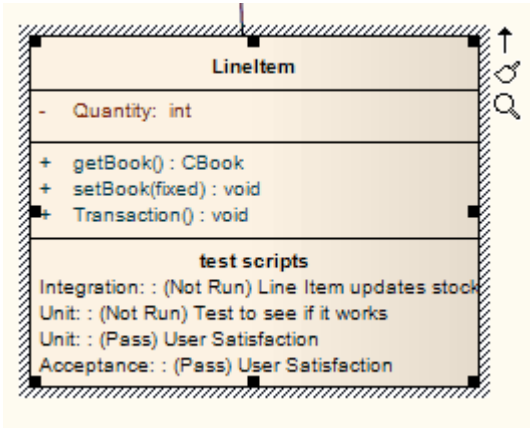
	<p>Click on the appropriate radio button option to associate the required testing feature with the element.</p>
	<p>Click on the OK button. The 'Test Details' dialog opens.</p>
	<p>Complete the fields to define the test activity, and then click on the Apply button. The test is added to the element.</p>
	<p>To create a subsequent test activity of this type, click on the New button.</p>  <p>The screenshot shows a UML class diagram for 'LineItem'. It includes an attribute '- Quantity: int', methods '+ getBook(): CBook', '+ setBook(fixed): void', and '+ Transaction(): void'. Below the methods is a section titled 'test scripts' containing three entries: 'Integration: : (Not Run) Line Item updates stock', 'Unit: : (Not Run) Test to see if it works', and 'Acceptance: : (Pass) User Satisfaction'. The diagram is enclosed in a dashed border with a search icon and an upward arrow on the right side.</p>

Notes

- To ensure that the test items are visible in the diagram element, as shown in step 7, select the 'Testing' checkbox on the 'Elements' tab of the 'Properties' dialog for the

diagram

Non-printable Elements

When you intend to generate a report that depicts diagrams from your model, you might decide that you do not want to show certain elements on a diagram in the report. You might have, for example:

- Notes and Text elements containing short pieces of information or explanations
- Artifact elements containing standards or instructions in Linked Documents
- Any other element that is not relevant to the purpose or subject of the report

You can exclude such elements (with their connectors) from being printed in any depiction of the diagram in a report, by manipulating the 'Printable' status of each non-relevant element. Conversely, you can force the inclusion of these non-printable elements in the printed diagram, by turning off the 'Hide non-printable objects' option in report generation.

Configure the Printable Attribute

All elements added to a diagram have the status 'Printable' by default. To turn this off and make an element non-printable (or turn it back on again) right-click on the element and click on the 'Printable' option.

You can turn this option on or off for multiple elements, by selecting the elements and right-clicking on one of them to

display the context menu, then clicking on the option.

Activate Printable Option for Reports

You can control the printing of non-printable elements on depictions of diagrams in reports, through the 'Options' page of the 'Document Generation' dialog.

Option	Action
Using in Custom Reports	<p>Select the parent Package or element for the diagram, and press F8; set up your report generation parameters as required.</p> <p>On the 'Options' page, the 'Hide non-printable objects' checkbox defaults to selected, to omit all elements that have the 'Printable' option turned off from depictions of diagrams in the report.</p> <p>If you want to include non-printable elements in the diagrams in the report, click on the checkbox to clear it.</p>
Using in Document Templates	<p>The 'Hide non-printable objects' option is a global, registry, setting and cannot be turned off in document templates or in document generation through the Automation Interface.</p>

Notes

- Turning off the 'Printable' option for an element also hides the element and its connectors when you print the diagram, print to PDF and save an image of the diagram

Manage Model Change

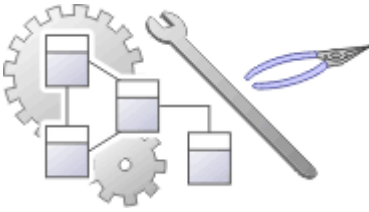

As users contribute new content and change existing content, a repository will become a valuable data store of organizational information assets. It is imperative that this asset is protected and changes are managed and controlled including being able to revert models back to previous versions or states. Enterprise Architect has a number of sophisticated tools to ensure the information is protected, including full integration with all the leading Version Control Systems, Baselines that are snapshots of your model that can be taken at important milestones, and Auditing that can track the finest changes to a model. A Project Transfer function helps you to make backups of models without involving information technology personnel. There are also Model Validation and Project Integrity Checkers to ensure the repository is maintained with a clean bill of health, and an effective role based Security System to ensure users can collaborate easily and sections of the model can be locked to users or groups.

Facilities

Facility	Detail

<p>Baselines</p>	<p>Baselines create snapshots of model content; a changed model can then be compared to the snapshot and changes can be reverted to the Baseline content if required.</p> <ul style="list-style-type: none"> • Baselines are created at the Package level providing snapshots of an entire Package including elements, features and diagrams and optionally also the Packages it contains • As a model is altered the changed Package can be compared with a baseline, including visual diagram changes and, if required, the current model can be reverted to the content stored in the Baseline • Baselines require no setup and provide an easy way for business and technical users to restore models to previous states at any level of granularity • Baselines created for Package-trees can be published for external use via the Reusable Asset Service (RAS)
<p>Reusable Asset Service</p>	<p>The RAS portion of the Pro Cloud Server helps you to define Packages that can be used in any model. A registered Package-tree includes:</p> <ul style="list-style-type: none"> • Version of the Package held in the

	<p>registry</p> <ul style="list-style-type: none"> • Diagrams and elements (including child Package elements) contained by the Asset Package • Dependencies on parent Packages of any external elements that the Asset Package references • Dependencies on MDG Technologies. <p>This makes everything required by that Package available to any repository that has access to that RAS, as well as features for comparing that RAS Package against a Package in the current model. The RAS service can also host Baselines.</p>
<p>Auditing</p>	<p>Auditing records changes to the content in a repository and provides a practical view that can be used to drill down into changes from the Package level down to changes to element features.</p> <ul style="list-style-type: none"> • Auditing is typically used by librarians and administrators to investigate who made a change to the model and the date and time it was changed • It can be used to locate problems in model development or for contractual reasons where third parties have been given access to manage model content

	<p>and the source of a change needs to be identified</p> <ul style="list-style-type: none">• Auditing can be enabled and disabled at any time and the audit logs can be saved and reload as needed
Version Control	<p>Version Control allows model content to be versioned allowing check-out and check-in of Packages to facilitate keeping track of different versions of parts of the model and allowing rollback to prior versions.</p> <ul style="list-style-type: none">• Coordinate sharing of Packages between users, with either read-only access or update access, ensuring that work on different areas of the model is coordinated and synchronous rather than conflicting• Allow check-out and check-in of Packages to and from working storage including users working offline.• Save and retrieve a history of changes to Packages <p>To use Version Control in Enterprise Architect, you require a third-party source-code control application such as:</p> <ul style="list-style-type: none">• Subversion• CVS

	<ul style="list-style-type: none">• MS Team Foundation Server (TFS), or• Any other Version Control product that complies with the Microsoft Common Source Code Control standard
Compare Projects	The Compare Project facility, compares a Source and Target Repository for differences and provides a summary of the changes to a repository, as a comparison of the number of rows in each table in the source and the target repositories.
Project Data Transfer	Enterprise Architect enables you to transfer project data between project data repositories either for: <ul style="list-style-type: none">• Sections of the project (XMI and CSV) or• The whole project, row by row, table by table (in the Corporate, Unified and Ultimate Editions of Enterprise Architect)

Timelines Window

The Timelines window is a collection of tab windows that provides facilities for viewing and managing snapshots and baselines associated with diagrams, packages and individual elements as they change over time, during the development of your model.

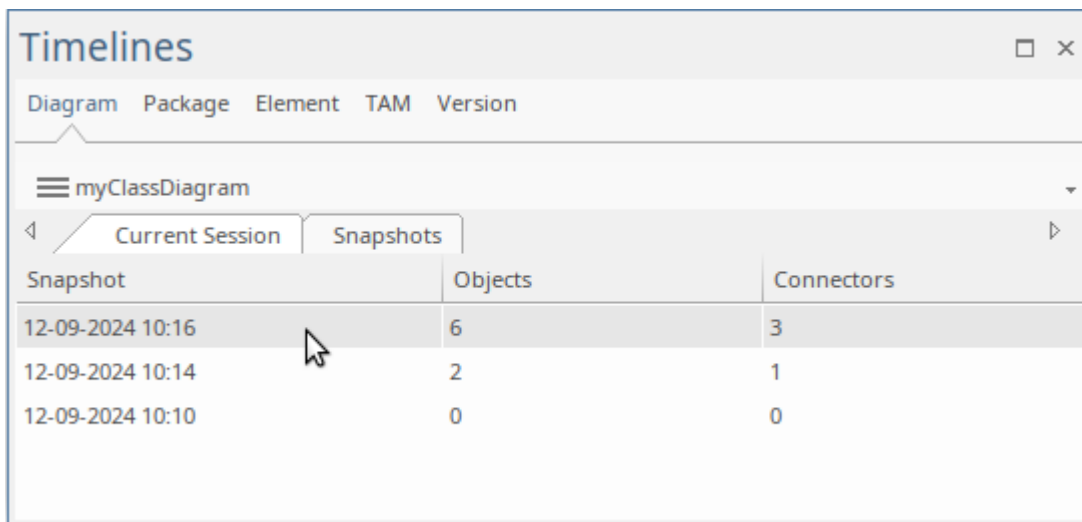

Access

Ribbon	Start > All Windows > Design > Diagram > Timelines
--------	--

The Diagram Tab

The diagram tab contains two sub-tabs, 'Current Session' and 'Snapshots', that are used to display and manage 'snapshots' of a diagram at various points in time as the model is developed.

The 'Current Session' sub-tab displays a list diagram snapshots for the current session. These snapshots are created when the current diagram is first opened, and thereafter, each time the diagram is saved. Current Session snapshots are stored in application memory. They are discarded when the application shuts down.

The 'Snapshot' sub-tab displays a list of diagram snapshots captured either automatically or manually. These snapshots are stored within the model database.

Each of the sub-tabs provides a range of commands for creating, displaying, saving and deleting the snapshots it displays. The menus are displayed by either clicking on the  icon, or right-clicking within the tab window. The menu options are described below.

Access

Ribbon	Start > All Windows > Design > Diagram > Timelines Diagram
--------	--

Current Session (sub-tab)

The 'Current Session' sub-tab displays a list of diagram snapshots for the current session. These snapshots are created when the current diagram is first opened, and thereafter, each time the diagram is saved.

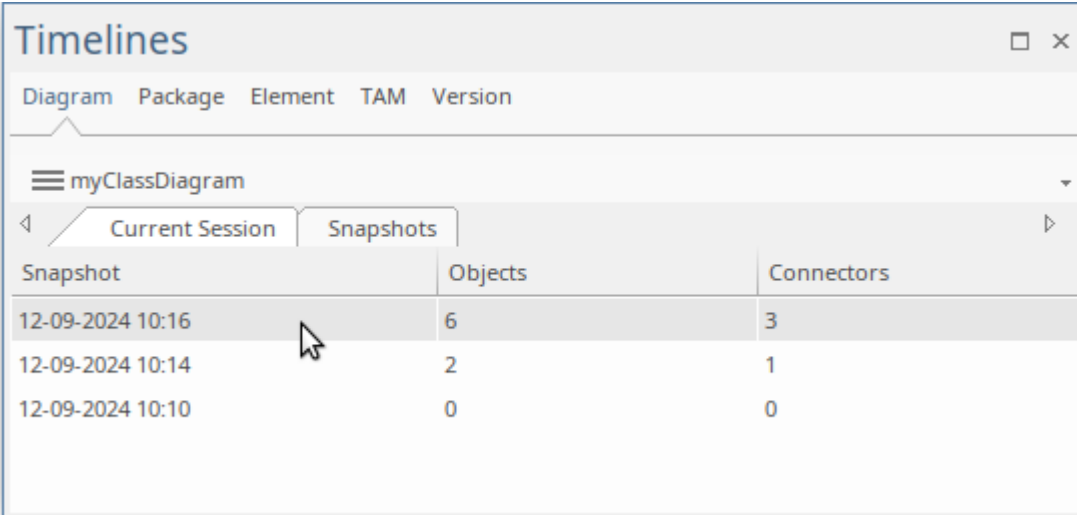

The screenshot shows a window titled 'Timelines' with a tabbed interface. The 'Current Session' tab is active, displaying a table with three columns: 'Snapshot', 'Objects', and 'Connectors'. The table contains three rows of data representing snapshots taken at different times on 12-09-2024.

Snapshot	Objects	Connectors
12-09-2024 10:16	6	3
12-09-2024 10:14	2	1
12-09-2024 10:10	0	0

The snapshot information is displayed as a table comprising three columns. The columns are described here:

Column	Description
Snapshot	The creation timestamp
Objects	The number of Objects on the diagram at the time of capture
Connectors	The number of Connectors on the diagram at the time of capture

Current Session Menu Options

The 'Current Session' sub-tab provides a range of commands for creating, saving, comparing and deleting the diagram snapshots. The commands are accessed via a menu, which is displayed either by clicking on the  icon in the title bar, or by right-clicking within the tab window. The menu options are described here:

Menu Option	Description
Show Snapshot	Shows the selected snapshot image in a popup viewer
Save to Snapshots...	Saves the selected snapshot image to model which then can be viewed in the adjacent 'Snapshots' tab
Delete Snapshot	Deletes the selected snapshot image from memory
Delete All	Deletes all of the currently listed snapshots from memory

Snapshot (sub-tab)

The 'Snapshot' sub-tab displays a list of diagram snapshots captured and stored within the model database. Diagram

snapshots can be captured both automatically and manually. To enable automatic snapshots, choose the ribbon option 'Settings | Model | Options | General | Snapshots'.

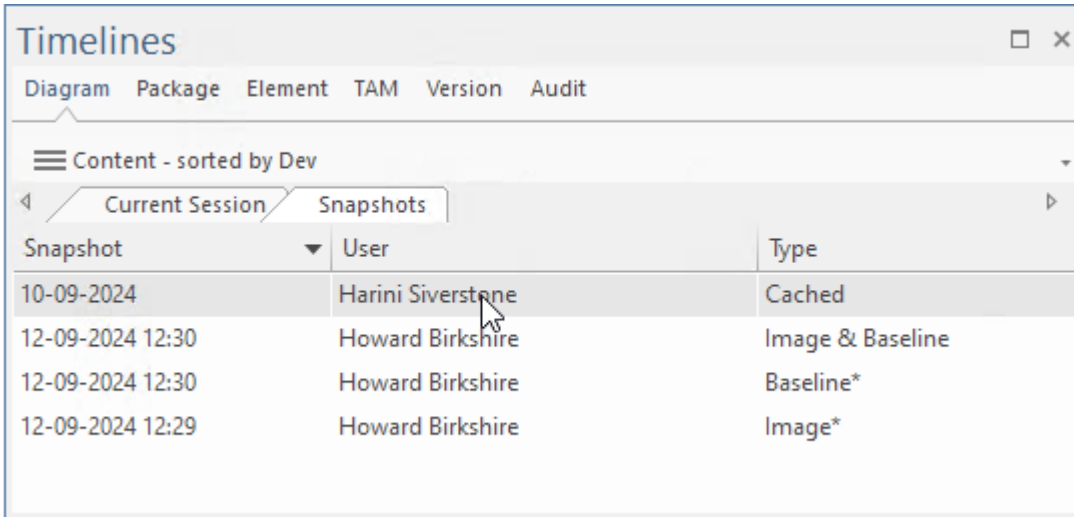

The snapshot information is displayed as a table comprising three columns. The columns are described here:

Column	Description
Snapshot	The creation timestamp
User	The ID of the user that created the snapshot
Type	Image, Baseline, Image & Baseline, Cached. (Cached is the captured image used for WebEA.) Additionally, an asterisk is used to indicate the following; <ul style="list-style-type: none"> Image* - the image is tagged as a filtered view

- | | |
|--|---|
| | <ul style="list-style-type: none"> • Baseline* - the baseline includes full object features |
|--|---|

Snapshot Menu Options

The 'Snapshots' sub-tab provides a range of commands for creating, saving, comparing and deleting the diagram snapshots. The commands are accessed via a menu, which is displayed either by clicking on the  icon in the title bar, or by right-clicking within the tab window. The menu options are described here:

Menu Option	Description
Create Image Snapshot...	Creates a stored image of the current diagram
Create Baseline Snapshot...	Creates a Native XML format snapshot of the current diagram and elements it contains
Create Both Snapshots...	Creates both an image and Native XML snapshot of the current diagram
Show Snapshot	Shows the selected snapshot image in a popup viewer
Compare	Compares the selected Native XML

Snapshot	snapshot with the current diagram and displays the results in the Snapshot Comparison view
Compare Selected Snapshots	Compares two selected Native XML snapshots. The results are displayed in the Snapshot Comparison window
Save Snapshot to Native XML File...	Exports the selected Native XML snapshot to a file
Show/Hide Comments	Show/Hide comments associated with the listed snapshots
Edit Comment...	Edit the selected snapshot's comment
Visible Timeframe	Filter the list of displayed snapshots, to show only those saved within the last specified number of days: Today, 2, 3, 5, 7, 30, 90
Show All	Clears the value for 'Visible Timeframe' and shows all captured snapshots
Delete Snapshot	Delete the selected snapshot

The Package Tab

The Package tab contains two sub-tabs, used to display and manage package snapshots and baselines, that capture the changing states of a package at various points in time as the model is developed. Snapshots capture the package information using Native XML format, whilst baselines capture package information using extended XML 1.1 format. All snapshots and baselines are stored within the model.

Each of the sub-tabs provides a range of commands for creating, displaying, saving and deleting the snapshots or baselines it displays. The menus are displayed by either clicking on the  icon, or right-clicking within the tab window. The menu options are described below.

Access

Ribbon	Start > All Windows > Design > Diagram > Timelines Package
--------	--

Snapshots (sub-tab)

The Snapshots sub-tab displays a list of snapshots of the currently selected package.

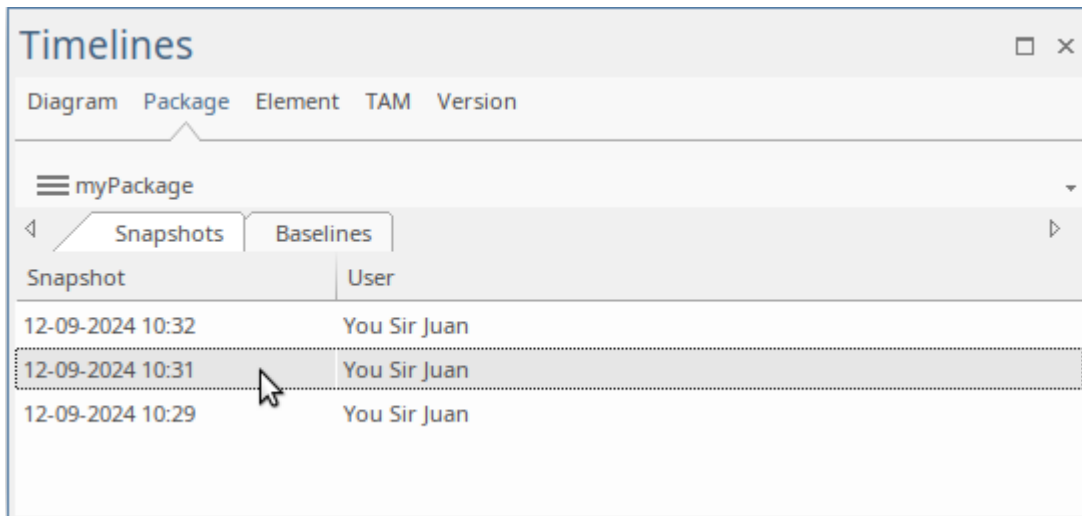

The information is displayed as table, with columns showing:

Column	Description
Snapshot	The creation timestamp
User	The ID of the user that created the snapshot

Snapshots Menu Options

The 'Snapshots' sub-tab provides a range of commands for creating, saving, comparing and deleting the package snapshots. The commands are accessed via a menu, which is displayed either by clicking on the  icon in the title bar, or by right-clicking within the tab window. The menu options are described here:

Menu Option	Description

Create Snapshot...	Creates a Native XML format snapshot of the current Package, Diagrams and Elements
Compare Snapshot	Compares the selected Native XML snapshot with the currently selected Package. The results are displayed in the Snapshot Comparison View.
Compare Selected Snapshots	Compares two selected Native XML snapshots and displays the results in the Snapshot Comparison window
Save Snapshot to Native XML File...	Exports the selected Native XML snapshot to a file
Show/Hide Comments	Show/Hide comments associated with the listed snapshots
Edit Comment...	Edit the selected snapshot's comment
Visible Timeframe	Filter the list of displayed snapshots, to show only those saved within the last specified number of days: Today, 2, 3, 5, 7, 30, 90

Show All	Clears the value for 'Visible Timeframe' and shows all captured snapshots
Delete Snapshot	Delete the selected snapshot

Baselines (sub-tab)

The Baselines sub-tab displays a list of Baselines for the currently selected package.

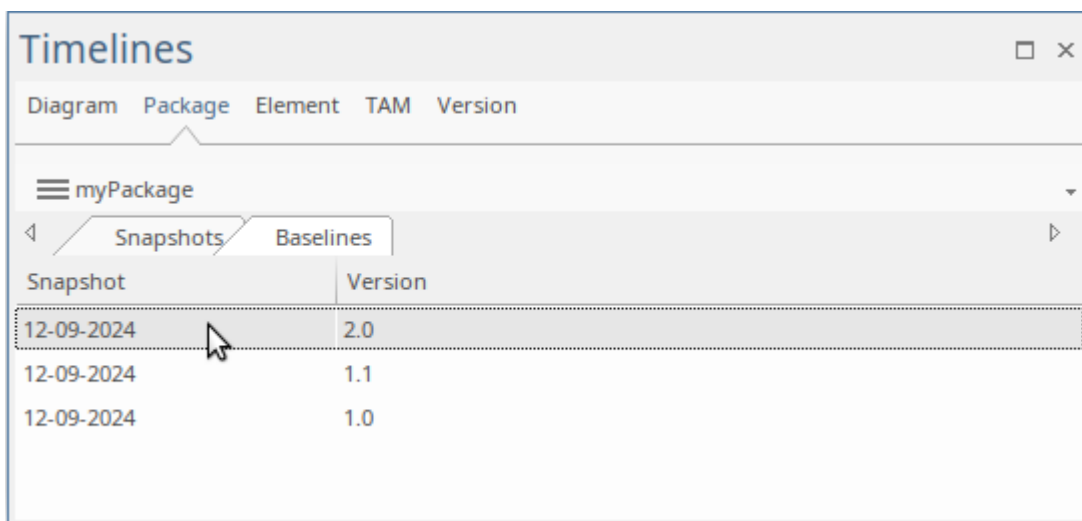

The information is displayed as a table, with two columns, showing:

Column	Description
Snapshot	The creation timestamp
Version	The baseline version label

Baselines Menu Options

The 'Baselines' sub-tab provides a range of commands for managing and comparing the package baselines. The commands are accessed via a menu, which is displayed either by clicking on the  icon in the title bar, or by right-clicking within the tab window. The menu options are described here:

Menu Option	Description
Create Package Baseline...	Create a XML 1.1 Baseline of the selected Package
Compare Baseline	Compares the current Package with the selected Baseline, and displays the results in the Baseline Comparison view
Open Baselines...	Display the Baselines dialog, with the currently selected item highlighted
Show/Hide Comments	Show/Hide comments associated with the listed baselines
Visible Timeframe	Filter the list of displayed baselines, to show only those saved within the last specified number of days: Today, 2, 3, 5, 7, 30, 90

Show All	Clears the value for 'Visible Timeframe' and shows all baselines
----------	--

The Element Tab

The Element tab is used to display and manage element snapshots, that capture the changing states of an element at various points in time as the model is developed. The snapshot information is stored within the model database using Native XML format.

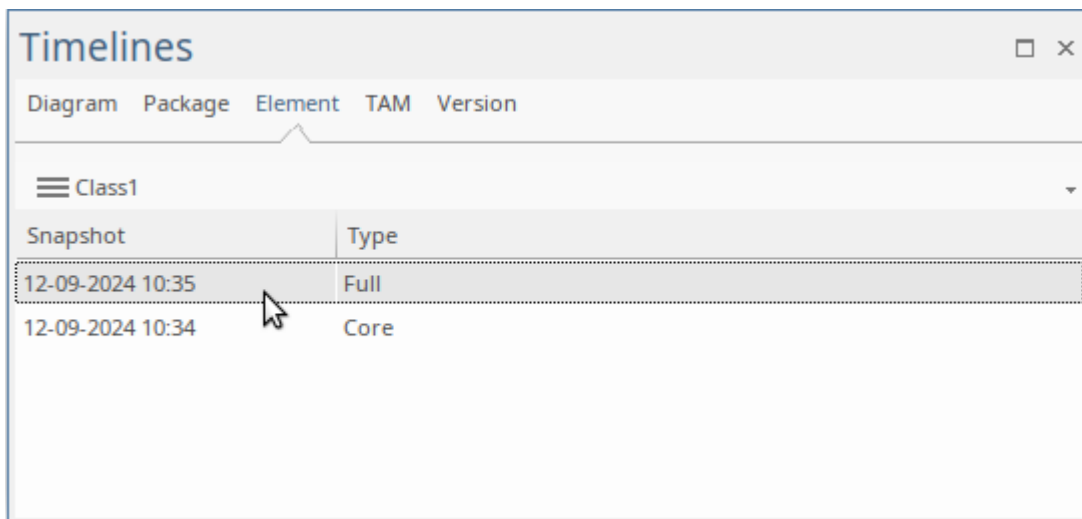

The list of snapshots is shown as a table comprising two columns:

- Snapshot - the creation timestamp
- Type - either Full (the full object features are stored in the snapshot) or Core (only the core properties are stored in the snapshot).

Access

Ribbon	Start > All Windows > Design > Diagram > Timelines Element
--------	--

Menu Options

The 'Elements' tab provides a range of commands for creating, saving, comparing and deleting the element snapshots. The commands are accessed via a menu, which is displayed either by clicking on the  icon in the title bar, or by right-clicking within the tab window. The menu options are described here:

Menu Option	Description
Create Snapshot...	Creates a Native XML format snapshot of the currently selected Element.
Compare Snapshot	Compares the selected Native XML snapshot with the currently selected Element. The results are displayed in the Snapshot Comparison View.
Compare Selected Snapshots	Compares two selected Native XML snapshots and displays the results in the Snapshot Comparison window.
Save Snapshot to Native XML File...	Exports the selected Native XML snapshot to a file.

Show/Hide Comments	Show/Hide comments associated with the listed snapshots.
Edit Comment...	Edit the selected snapshot's comment.
Visible Timeframe	Filter the list of displayed snapshots, to show only those saved within the last specified number of days: Today, 2, 3, 5, 7, 30, 90
Show All	Clears the value for 'Visible Timeframe' and shows all captured snapshots.
Delete Snapshot	Delete the selected snapshot.

The TAM Tab

The TAM (Time Aware Modeling) tab displays the hierarchy of Ancestor/Clone relationships and provides access to compare differences between models.

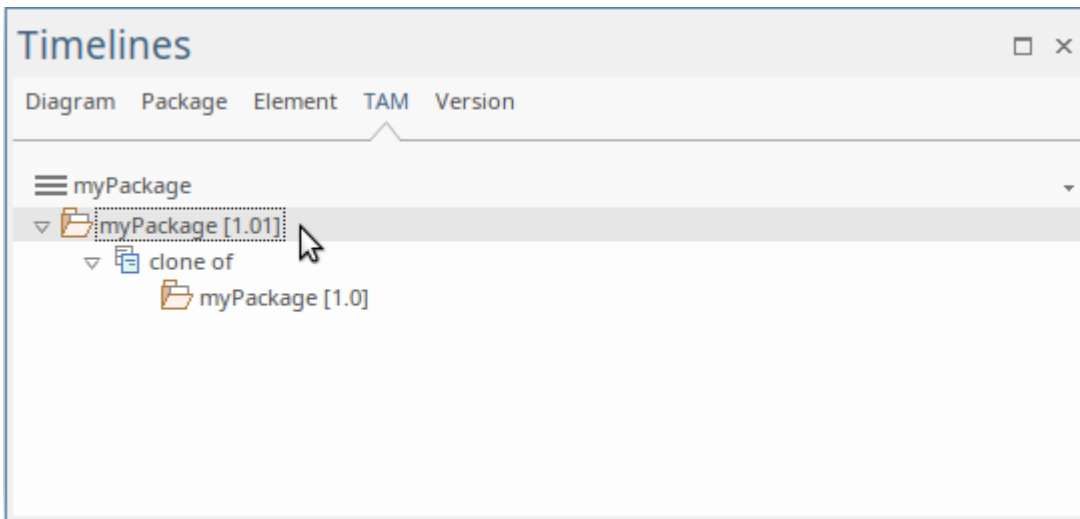

Access

Ribbon	Start > All Windows > Design > Diagram > Timelines TAM
--------	--

Drop-down Menu

The drop-down menu is displayed by clicking on the hamburger icon (or anywhere in the title bar that contains the icon).

Menu Option	Description
-------------	-------------

Switch to Related Element	Switches context to the selected item
View Related Element Properties	Switches the context to the selected item
Find in all Diagrams	Display a list of all diagrams containing the selected item.

Context Menu

The context menu is displayed by right-clicking within the TAM tab window.

Menu Option	Description
Clone Structure as New Version...	Clones the currently selected structure as a new version. Enables with context Package
Compare with Version	Clones the currently selected structure as a new version. Enables with context Package

The Version Control Tab

The Version Control tab of the Timelines window allows users to view a comprehensive list of revisions for packages, diagrams, and individual model elements that are under version control. Users can utilize this feature to view all revisions of the version-controlled package containing the selected model element.

Additionally, it enables users to compare the model content against any selected revision from version control.

Access

Keyboard	"Alt +1", then choose "Diagram > Timelines". In the "Timelines" window, open the "Version" tab.
Ribbon	"Start > All Windows > Design Diagram Timelines" or "Design > Diagram > Manage Tools Timelines" In the "Timelines" window, open the "Version" tab.

Selecting Model Elements for Comparison

To choose a model element for comparison, you have several options: you can select an element (a package, diagram, or individual element) in the Browser window, pick an element from a diagram, or click on an open diagram. You can make your selection before opening the Timelines window's Version page, and you can also modify your selection after the Timelines window is open.

Performing Comparisons

With the 'Version' page of the 'Timelines' window displayed, select a model element, then on the 'Version' page, select the revision against which you wish to perform a comparison. Right-click on the revision and choose the menu option "Compare model to selected revision".

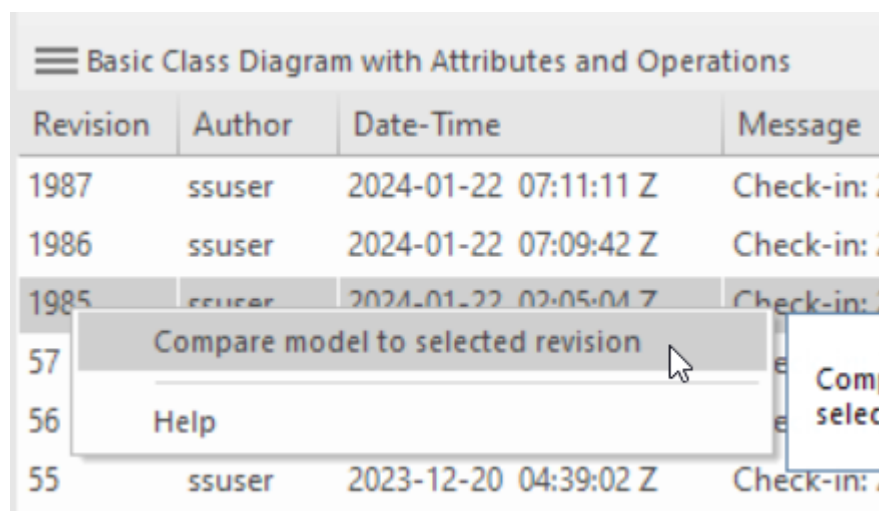

Revision	Author	Date-Time	Message
1987	ssuser	2024-01-22 07:11:11 Z	Check-in: ...
1986	ssuser	2024-01-22 07:09:42 Z	Check-in: ...
1985	ssuser	2024-01-22 07:05:04 Z	Check-in: ...
57			
56			
55	ssuser	2023-12-20 04:39:02 Z	Check-in: ...

The 'Comparison' window will open, showing the differences between the model and the selected 'baseline'.

While the comparison is performed at the level of the version controlled package, the results window will initially display the differences for the selected model object,

whether it be a package, a diagram or a single model element.

Within the results window, you can subsequently choose other model objects for which to display differences.

Menu Options

A range of version control operations is also available through the drop-down menu at the top of the 'Version' page.

These commands operate on the version controlled package that contains the selected package, diagram or element.

Where the selected package is itself version controlled, the operations will act on that package.

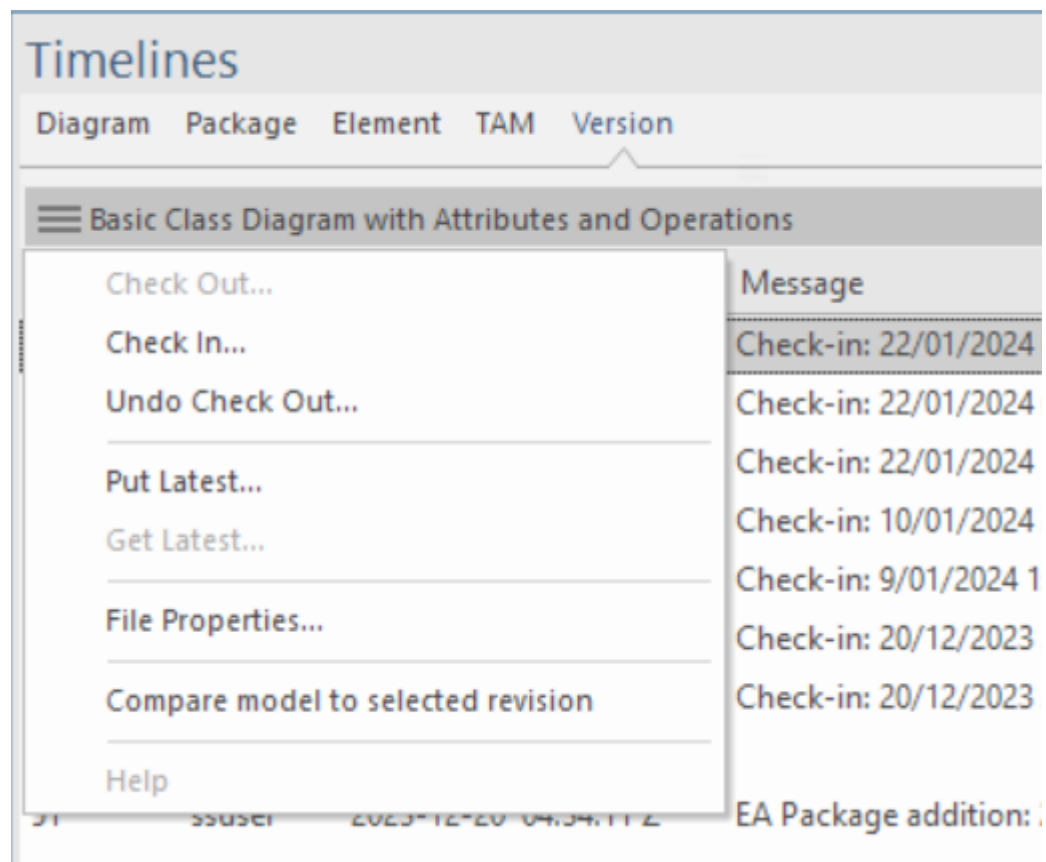

Menu Option	Description
Check Out...	<p>Synchronize the currently selected Package with the latest revision from the Version Control repository and unlock the Package to allow editing.</p> <p>Only available for Packages that are not already checked-out (and whose associated Package file is not checked-out).</p>
Check In...	<p>Commit a new revision of the currently selected Package to the Version Control repository and lock the Package against further editing.</p> <p>Only available for Packages that you have checked-out yourself.</p>
Undo Check Out...	<p>Reverses the check-out of a Package, discarding any modifications that have been made by restoring the Package content to the latest revision held in Version Control.</p>
Put Latest...	<p>Commit a new revision of the currently selected Package to the Version Control system, while keeping the Package</p>

	<p>checked-out.</p> <p>This is equivalent to checking a Package in and immediately checking it back out again.</p> <p>Only available for Packages that you have checked-out yourself.</p>
Get Latest...	<p>Synchronize the currently selected Package with the latest revision from the Version Control repository.</p> <p>Available only for Packages that are checked in.</p>
File Properties...	<p>Display Version Control properties pertaining to the XMI export file associated with the currently selected Package; this also identifies who has checked out the Package.</p>
Compare model to selected revision	<p>Invokes a comparison between the version controlled package in the model and the selected revision of the same package in version control.</p> <p>While the comparison is performed at the package level, the results window will</p>

	display a comparison for the model object that is currently selected.
Help	Opens a web browser and loads the User Guide page related to the VC page of the Timelines window (this page).

Notes

This feature is only available for use with the following version control providers:

- Microsoft Team Foundation Server
- Subversion

The Auditing Tab

The Audit tab list the context item's audit logs to provide access to the ‘System Output > Audit History’ for quick access without having to open the Auditing window.

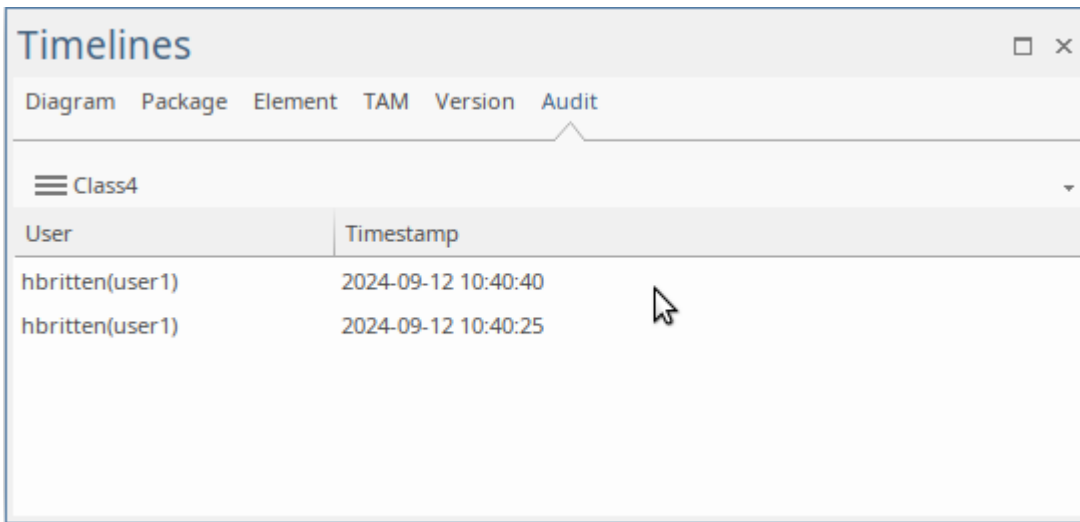

The audit log items are displayed as a table with two columns:

- User - The logged-in user that made the change
- Timestamp - The timestamp attached to the change

Access

<p>Ribbon</p>	<p>The Audit tab list the context item's audit logs to provide access to the ‘System Output > Audit History’ for quick access without having to open the Auditing window.</p>
---------------	--

Drop-down Menu

Menu Option	Description
Show Audit Window	Opens the Audit View window

Notes

The Audit tab is only available in models for which auditing is enabled.

Tracking Change

If you want to track changes to data across your project, you can use two separate but complementary facilities - Auditing and Baselines.

Facilities

Facility	Detail
Auditing of model changes	<p>Auditing is a project-level feature, available in the Corporate, Unified and Ultimate Editions, that enables you to record model changes in Enterprise Architect.</p> <p>By enabling this feature, model administrators can view a range of information regarding changes, such as:</p> <ul style="list-style-type: none"> • Who changed an element • How many elements they changed • When they changed the data • What the previous values were, and • What type of elements they changed
Baselining and differencing	<p>The Enterprise Architect Corporate, Unified and Ultimate Editions provide a facility to 'baseline' or snapshot a model</p>

to capture and roll back changes

branch in XMI format at a particular point in time, and store it within the model in compressed format.

More than one baseline can be stored against a single Enterprise Architect Package; using baselines, you can compare Packages at the current and earlier stages of development, using the Compare (Diff) utility.

The Compare utility is available in the Professional, Corporate, Unified and Ultimate Editions of Enterprise Architect; it enables you to compare the current model with:

- A Baseline
- An exported Enterprise Architect XMI file in the file management system
- A version-controlled Enterprise Architect XMI file in the file management system

Baselines

Baselines are snapshots of parts of the repository at a given point in time, that can be used for later comparison and restoration, if required.

A Baseline creates a snapshot of a model Package and its contents at a point in time and, as the model changes, allows you to compare the current state and the snapshot; if required you can revert to the previous (baselined) state.

Baselines are created at the Package level and can include child Packages; any number of Packages can be baselined, and a Package can be baselined any number of times, typically at important project milestones. Baselines are by default conveniently stored within the repository making them available to any model user who has the security privileges to work with them. Alternatively, a Baseline can be stored in a Cloud-based Reusable Asset Service. These options will be explored in a later topic.

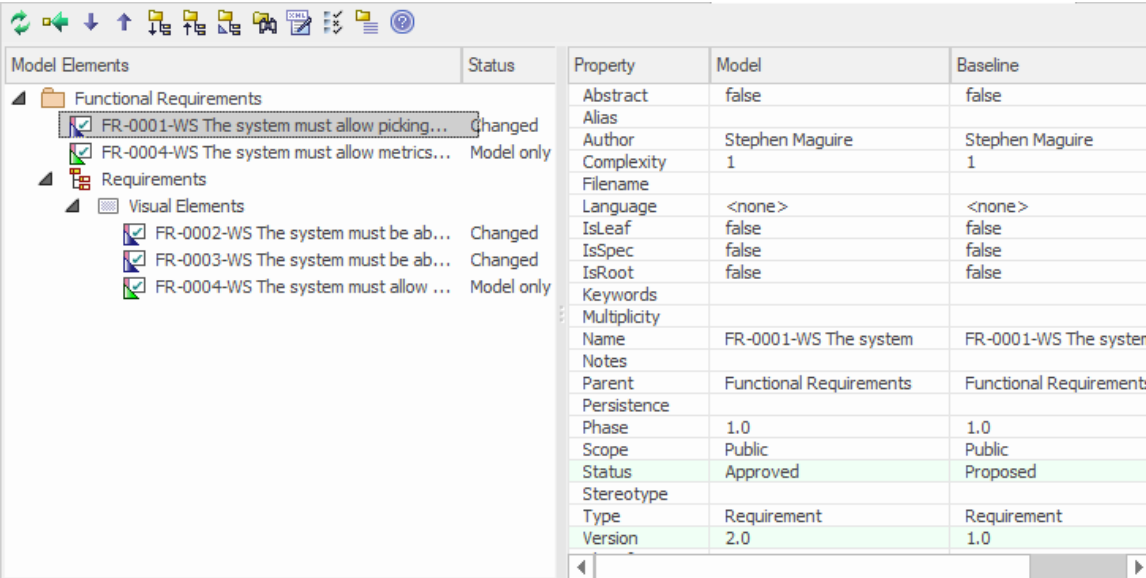

Model Elements	Status	Property	Model	Baseline
Functional Requirements		Abstract	false	false
FR-0001-WS The system must allow picking...	changed	Alias		
FR-0004-WS The system must allow metrics...	Model only	Author	Stephen Maguire	Stephen Maguire
Requirements		Complexity	1	1
Visual Elements		Filename		
FR-0002-WS The system must be ab...	Changed	Language	<none>	<none>
FR-0003-WS The system must be ab...	Changed	IsLeaf	false	false
FR-0004-WS The system must allow ...	Model only	IsSpec	false	false
		IsRoot	false	false
		Keywords		
		Multiplicity		
		Name	FR-0001-WS The system	FR-0001-WS The system
		Notes		
		Parent	Functional Requirements	Functional Requirements
		Persistence		
		Phase	1.0	1.0
		Scope	Public	Public
		Status	Approved	Proposed
		Stereotype		
		Type	Requirement	Requirement
		Version	2.0	1.0

This diagram illustrates the Baseline comparison tool,

showing model and Baseline properties; Status and Version have changed.

Baselines are a type of insurance policy that ensures you can always revert to a previously captured state. In this topic you will learn how to create Baselines, and some of the common business and technical purposes of the technique. You will also learn to use the comparison tool, which allows you to identify what has changed in the model since a Baseline (snapshot) was created. You can reverse changes back to the Baseline state at any level of granularity. This will be indispensable when working with Project Teams using conventional or agile techniques, or, where there are important governance or contractual requirements to manage change.

Current Repository or Reusable Asset Service

Baselines can be stored in the same repository in which the source Packages are located. They can also be stored in a Reusable Asset Service (RAS), and made accessible to users working on other repositories that have access, via a Pro Cloud Service, to the RAS repository.

These topics discuss the management of Baselines, including exploring the options and benefits of storing them in the repository or, alternatively, in a Reusable Asset Service (RAS).

Brief Introduction

Baselines are easy to set up and require only a small amount of meta-data, such as the Version Number and some Notes that are pre-filled with the time and date the Baseline was created. You can add your own comments such as 'After Requirements Sign-Off' to indicate the significance of a milestone or reason for the Baseline.

The basic steps in working with Baselines are:

1. Create a Baseline - this will be for a selected Package and optionally its child Packages.
2. Compare the model to the selected Baseline - there can be multiple Baselines of the same Package.
3. Revert the model to one or more Baseline items - or choose to ignore the differences.

It is important to understand a fundamental difference between Baselines and Version Control. Baselines are user-initiated, so if a user has not created a Baseline for a given Package at a previous time it is not possible to compare the model to an earlier 'version'. However, once Version Control is set up for a Package, any changes that are made to the Package will be automatically versioned and will be available at a later time. These two facilities can be used in conjunction and it would be the responsibility of a Librarian or Administrator to determine how best to use them together.

Baselines are stored in the same XML format as is used for Version Control, but are stored in compressed format either

within the project or in a Reusable Asset Service Registry. By default, Baselines are stored within the model; you can save a Baseline to an external XML file for storage or archive, or for distributing to other users working on models derived from a master project.

Creating Baseline

With a Package selected in the Browser window, choose the 'Create Baseline' option to create a new Baseline of the selected Package. You will be required to complete some details for the Baseline, as indicated:

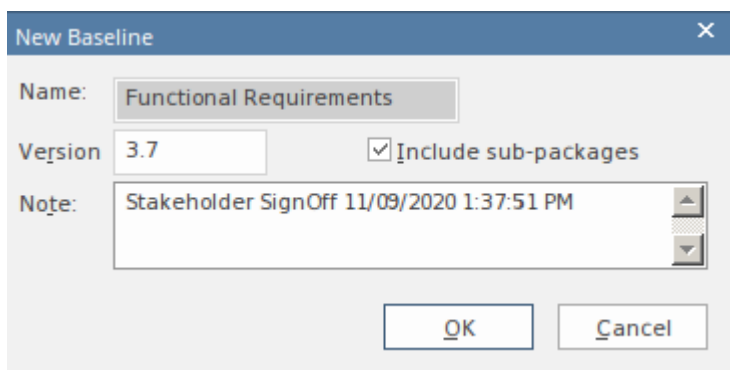

New Baseline window showing details entered when creating a Baseline, including the version number.

- Version - a user defined version number used to identify the Baseline when running comparisons
- Include sub-packages - choose whether to Baseline subordinate Packages as well as the main Package
- Notes - used to describe the Baseline; e.g. 'Requirements Sign-Off' pre-filled with the Baseline time and date

Comparing to the Model

The management of baselines makes use of the comparison tool and presents a tabular presentation of the differences. The comparison tool shows the differences between the elements, their properties and features, relationships or visual changes in diagrams at the current time and the time of the baseline or model export. A tree view presents the comparison items and can be used to navigate through the changes which are presented on the panel on the right hand side.

Reverting to Baselines

Once the comparison (differencing) is complete, you can revert changes by merging information from the Baseline into the current project; it is not possible to go the other way.

You can:

- Merge information manually, change by change
- Merge information automatically by electing to merge in all changes in one batch procedure
- Revert completely to the original Baseline by importing the stored XMI directly
- Merge information and elements from a Baseline in a different project, making it possible to keep multiple versions of a single model in synch

The merge options are available through the toolbar, context menus and the keyboard on the 'Compare Utility' view, which shows the results of a comparison.

Visual Differencing

Changes to a model might include:

- Adding or removing or changing elements and connectors on a diagram, or
- Changing the position of elements or the overall layout of a diagram

You might believe that a diagram has changed, and select to compare it with a baseline using a ribbon option.

Alternatively, you might perform a baseline comparison on a Package or a model and select from the comparison output any diagrams that are flagged as changed.

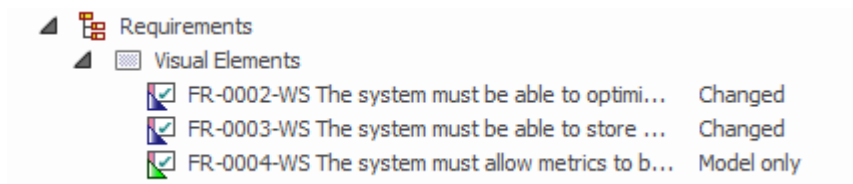

Visual (diagram) differences for a number of existing and new requirement elements.

Creating Baselines

This topic details the basics of creating new Baselines of model Packages. You can create Baselines in the model (using the 'Baselines' dialog) or in a Reusable Asset Service Registry (using the 'Reusable Asset Service - Baseline' view). The appropriate screen displays by default according to whether the 'Store Package Baselines in a Reusable Asset Service Registry' checkbox is selected on the 'Baselines' page of the 'Manage Model Options' dialog.

Access

Select a Package in the Browser window, then open the appropriate screen for the storage system using one of the methods outlined here.

Ribbon	Design > Package > Manage > Manage Baselines : 'Baselines' dialog : New Baseline (or) Design > Package > Manage > Manage Baselines : 'Reusable Asset Service - Baseline' view : New
Keyboard Shortcuts	Ctrl+Alt+B : 'Baselines' dialog > New Baseline (or) Ctrl+Alt+B : 'Reusable Asset Service - Baseline' view : New

Create a new baseline

Field	Action
Name	Display the Package name of the currently selected model branch.
Version	Type a unique version reference for this Baseline, which can consist of any alphanumeric characters. The 'Package Baselines' dialog sorts the Baselines according to the value of this field.
Include sub-Packages	Include the entire sub-Package hierarchy of this branch in the Baseline; this option defaults to selected. If you deselect the checkbox, only the immediate contents (XMI stubs) of the Package are included in the Baseline.
Note	Edit the default current time and date to any other value. The field is a single-line entry, for display on the 'Package Baselines' dialog (a one-line-per-entry list).

OK	Click to create a new Baseline and return to the 'Package Baselines' dialog.
----	--

Compare a Model to Baselines

A Baseline is created with an intention that it could be required as a backup or point of reference at some time in the future, so that a model that has changed can be compared with the snapshot and differences determined. This might be required just to identify that differences exist, or so that the entire Package or individual changes can be rolled back to the state contained in the Baseline (snapshot). The first step in this process is to locate the required Baseline and then to identify the differences. The Baseline Comparison tool can be used to visualize the changes that have occurred between the time of the Baseline and the current time. Individual changes are not recorded as they are in the auditing facility, but rather the accumulative results of the changes are presented.

Find Baselines

You can locate the Baselines for a model by selecting a Package in the Browser and then opening the Manage Baselines window. In the event that you have forgotten or are unsure of the location of one or more Baselines you can use the Model Search utility to locate all Packages that have Baselines. The window conveniently displays the name of the Package and the Baseline Version, Date and Notes. From this window you can locate the Package in the Browser window and then launch the Manage Baselines window.

Find in Project x

Common Searches Find Baselines <Search Term>

Drag a column header here to group by that column.

Name	Baseline_Version	Baseline_Date	Baseline_Note
Requirements	2.0	6/10/2020 9:36:08 AM	After Initial SignOff 6/10/2020 9:35:39 AM
Functional Requirements	3.5	6/10/2020 11:45:27 AM	After Stakeholder Meeting 6/10/2020 11:44:46 AM
Conceptual Data Models	2.1	6/10/2020 11:46:45 AM	Data Owner Agreement 6/10/2020 11:46:22 AM

The Compare Utility (Diff)

Enterprise Architect has a comprehensive built-in Compare (diff) utility, which enables you to:

- Explore what has changed within a model over time
- Explore how previous versions of a model branch differ from what is currently in the model
- Perform a full model comparison by exporting all of Model A to XMI, then using 'Compare Model to File' from within the current model (Model B)

Comparing and checking model development at various points in the process is an important aspect of managing change and development, monitoring what is being modified and ensuring the development and design process is on track.

Using the Compare Utility you can Compare a model branch in Enterprise Architect with:

- A Baseline created using the Baseline functionality (Corporate, Unified and Ultimate Editions)
- A Baseline stored in a different model
- An XML 1.1 file created previously using the Enterprise Architect XML export facility (user selects file)
- The current version-controlled XMI 1.1 file as created when using Version Control in Enterprise Architect (file automatically selected)

Access

Select a Package in the Browser window, then open the 'Baselines' dialog or 'Reusable Asset Service - Baseline' view (depending on whether Baselines are stored in model or in a Registry) using one of the methods outlined here.

Ribbon	<p>Publish > Model Exchange > Package Control > Compare Package to XMI</p> <p>Design > Package > Manage > Manage Baselines : Show Differences ('Baselines' dialog)</p> <p>Design > Package > Manage > Manage Baselines : Compare ('Reusable Asset Service - Baseline' view)</p>
Keyboard Shortcuts	<p>Ctrl+Alt+B : Show Differences ('Baselines' dialog)</p> <p>Ctrl+Alt+B : Compare ('Reusable Asset Service - Baseline' view)</p>

Differencing With Baselines

As a Baseline contains all information about elements and connections for a Package at a point in time, it can be used within Enterprise Architect to track changes to model elements over time.

The Differencing engine first builds a representation of the current Package in memory, based on what is currently in the model.

It then compares this with the stored Baseline, highlighting changes, new elements, missing elements and elements that have been moved to other Packages.

It is possible to filter the resultant output to display only one particular kind of change: for example, additions to the model.

If a Baseline has been created to ignore child Package content, a comparison between that Baseline and the model does not include any child Package content in the model.

See the example provided in the *Example Comparison* Help topic.

Notes

- This utility is available in the Professional, Corporate, Unified and Ultimate Editions of Enterprise Architect
- You cannot compare the current model with an XMI 2.1 file; the utility can only compare with an XMI 1.1 file

Compare Options

You use the 'Baseline Compare Options' dialog to refine the output of the Compare utility when it compares the current model with a Baseline.

To display the dialog, either:

- Click on the Options button on the 'Package Baselines' dialog, or
- Click on the 'Compare Options' icon in the 'Compare Utility' view toolbar

If the 'Compare Utility' view shows the results of a Baseline comparison, when you click on the OK button the display refreshes to refine the information according to the options you have selected.

Options

Option	Action
Always Expand to Differences	Always display the list of elements fully expanded to show changes. If you deselect the checkbox, when the 'Compare Utility' view is first opened it lists the Package contents to element level, and you expand each element as required to show the changed items. For large branches of the model, it is

	<p>better to leave the checkbox unselected.</p>
<p>Show Elements that are</p>	<p>List elements that:</p> <ul style="list-style-type: none"> • Have been changed since the Baseline was created • Are in the Baseline only (that is, have been deleted from the model since the Baseline was created) • Are in the model only (that is, have been created since the Baseline was created) • Have not changed since the Baseline was created (you might generally leave this checkbox unselected)
<p>Suppress these Changes</p>	<p>Exclude:</p> <ul style="list-style-type: none"> • Changes to diagrams • Changes to the 'Date Modified' field for an item • Changes to the 'Date Created' field for an item • Child items of a deleted item • Changes to advanced properties (defaults to selected) • Changes to the 'Author' field for an item
<p>Baseline</p>	<p>Select the checkbox to always open the</p>

Diagram Compare Option	first parent Package for which there is a Baseline, when you select the diagram for comparison from the Browser window.
------------------------	---

Notes

- Package Baseline facilities are available in the Corporate, Unified and Ultimate Editions of Enterprise Architect

Example Comparison

This diagram shows the result of a comparison between a Package (Log in/out Use Cases) in the current project and that Package in a Baseline captured at an earlier date.

The results of the comparison are displayed on the 'Comparison Utility' view.

Property	Model	Baseline
Abstract	false	false
Alias		
Author	rchester	rchester
Date Created	4/09/2013 2:47:50 PM	4/09/2013 2:47:50 PM
Date Modified	7/10/2013 11:37:55 AM	5/09/2013 2:39:04 PM
Complexity	2	1
Filename		
Language	<none>	<none>
IsLeaf	false	false
IsSpec	false	false
IsRoot	false	false
Keywords		
Multiplicity		
Name	Actor2	Act2
Notes		
Parent Package	Log in/out Use Cases	Log in/out Use Cases
Persistence		

Review Changes

Aspect	Description
Interpretation	<p>A hierarchy of model elements is displayed in the left-hand pane.</p> <p>From the triangle-based icons and the highlighted lines on the report, it is clearly visible which items in the hierarchy have, since the Baseline was captured, been:</p>

	<ul style="list-style-type: none"> • Changed • Deleted from the model (in the Baseline only) • Added to the model (in the Model only) or • Switched to different Packages (changes in the Parent Package property) <p>If you click on an item in the left hand pane, the right-hand pane displays a table of properties showing the values of those properties in the current model and in the Baseline.</p> <p>For each property where there is a difference between the model and the Baseline, the row is highlighted.</p> <p>The 'Compare Utility' view enables you to perform operations (such as merging or rolling back changes) on the reported information, using the toolbar, context menu and keyboard.</p>
<p>Increase Level of Detail</p>	<p>The right panel of the 'Compare Utility' view might, for some fields, display only part of the value.</p> <p>It might also not be immediately obvious what a change is.</p> <p>In either case, you can double-click on</p>

the property to display full details and to highlight the exact differences; this example shows the highlighted changes to the 'Name' property.

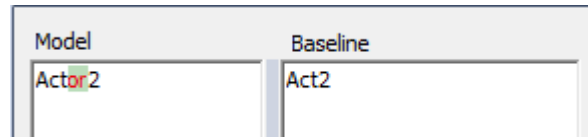

Notes

- The Compare utility is available in the Professional, Corporate, Unified and Ultimate Editions of Enterprise Architect

Compare Utility View Options

The 'Comparison Utility' view enables you to perform operations on the reported information, using the toolbar, context menu, 'Merge' dialog and certain keyboard keys.



- The toolbar is at the top of the left-hand panel; the icons operate either on the comparison as a whole or on the currently-selected item in the left hand panel of the 'Comparison Utility' view
- Each item in the hierarchy has a context menu, which you display by right-clicking on the item; the options displayed depend on the level of the item in the hierarchy
- The 'Merge' dialog enables you to specify which changes to roll back in the model from the baseline
- You can use a selection of keyboard keys to move up and down the hierarchy, or to roll back changes

Toolbar Options

Option	Action
Refresh	Re-run the comparison to refresh the current display.
Merge To Model	Merge the values of the currently-selected item in the Baseline

	back into the model.
Next Change	Highlight the next changed item (this skips Moved items).
Previous Change	Highlight the previously-changed item.
Expand All	Fully expand the selected item.
Collapse All	Collapse the changed items in the selected item.
Expand To Changed Items	Expand the selected item to show changed items only (in the event that you have selected to also show unchanged items in the comparison).
Find in Project Browser	Highlight the item in the Browser window.
Log To XML	Log the changes to an XML file. A browser displays, on which you specify the file name and location.
Compare Options	Display the 'Baseline Compare Options' dialog.

Manage Package Baselines	Re-display the 'Package Baselines' dialog or 'Reusable Asset Service - Baseline' view, as appropriate.
Help	Display the Help topic <i>Package Baselines</i> .

Context Menu Options

Option	Action
Merge from Baseline Add from Baseline	Restore the item in the model to the Baseline state, or restore a deleted item from the Baseline.
Delete from Model	Remove a recently-created item from the model.
Merge From Baseline (with Options)	(For the root node of the hierarchy on the 'Compare Utility' view.) Display the 'Merge' dialog, which you can use to specify options for rolling back the whole model branch to the Baseline state.

Refresh	(Object-level items.) Re-run the comparison to refresh the current display.
Find in Project Browser	Locate and highlight the item in the Browser window.
Open Baseline Diagram Compare	(For a diagram listed in the comparison.) Display the Baseline Diagram Compare window, showing differences in diagram content and layout.
Expand All	Fully expand the selected item.
Expand To Changed Items	Expand the selected item to show changed items only.
Collapse All	Collapse the changed items in the selected item.
Log To XML	Log the changes to an XML file. A browser displays, on which you specify the file name and location.
Baseline Compare	Display the 'Baseline Compare Options' dialog.

Options	
----------------	--

Merge Dialog Options

Option	Action
Changed	Restore all changed items in the model branch to the Baseline state.
In Baseline Only	Restore all deleted items to the model branch from the Baseline.
In Model Only	Remove all recently-created items from the model branch.
Moved	Restore all moved items to their original locations, as identified in the Baseline.
Full Restore from XMI	Completely restore the model branch to the version held in the Baseline XMI 1.1 file, (using the 'XMI Import' function). (This option automatically selects all the other options)

Keyboard Keys

- Ctrl+ ↓ - expand and highlight the next changed item
- Ctrl+ ↑ - expand and highlight the previous changed item
- Ctrl+ ← - undo the changes for a selected item (roll back to the Baseline values)

Visual Diagram Changes

The Baseline Diagram Compare feature is a quick and easy way to visually compare a current diagram with an earlier version from a saved Baseline, and highlight any elements in the diagram that have been added, deleted, resized or moved.

You can then review these changes and optionally roll back individual changes if needed to their previous state from the Baseline.

The changes are identified on the 'Baseline Diagram Compare' dialog and on the diagram itself.

Access

Select the diagram to be checked, then apply one of these access methods:

Ribbon	Design > Diagram > Manage > Compare to Baseline (on an open diagram)
Other	<ol style="list-style-type: none">1. Perform a comparison of a Package and Baseline (see <i>The Compare Utility (Diff)</i> Help topic).2. Locate the diagram in the results on the 'Baseline Comparison' view.3. Right-click on the diagram name and select the 'Compare to Baseline' option

	to display the 'Baseline Diagram Compare' dialog and to open the diagram (refer to the <i>Results</i> section).
--	---

Multiple Owner Packages

When you create a Baseline, it can be for a Package that contains one or more levels of child Package, and you might create Baselines for the Package(s) at each level. If the diagram you are checking is at a lower level in the hierarchy, there might therefore be a number of Baselines that contain information on the diagram, perhaps taken at different times and capturing different changes to the diagram.

When you open the diagram before performing the check, and select one of the direct ribbon access paths, if the diagram is referenced in multiple Baselines you might be required to select the Package from which to use a Baseline, on the 'Load Baselines from Package' dialog.

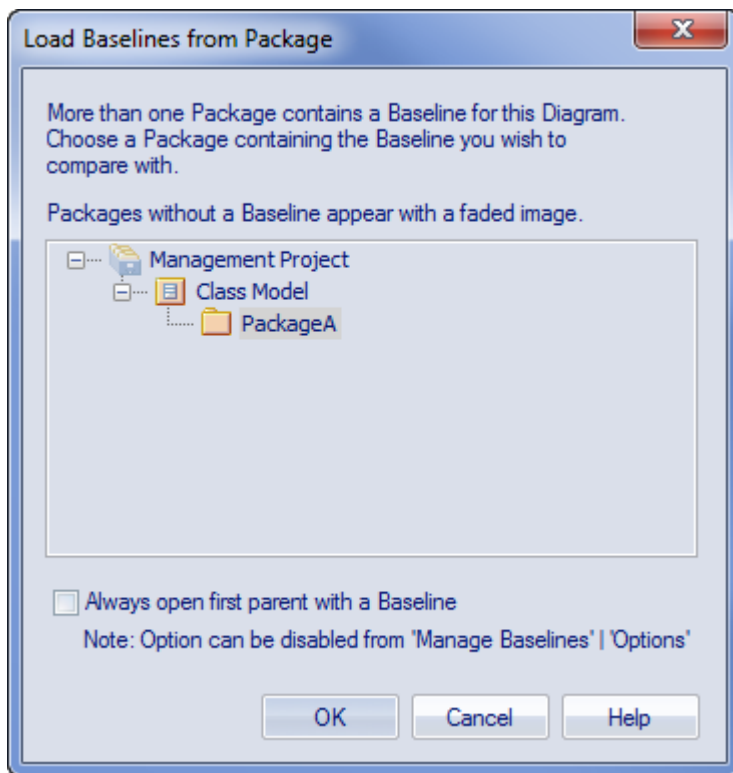

The 'Load Baselines from Package' dialog provides the facility to compare the diagram with one of a broader range of Baselines than just those from the diagram's immediate parent.

This dialog displays if you have NOT selected the 'Always open first parent with a Baseline' checkbox on either:

- The 'Load Baselines from Package' dialog itself or
- The 'Baseline Compare Options' dialog

Selecting or deselecting the option in one location also selects or deselects it in the other.

Click on the required Package, and click on the OK button. In this case, **or** if the dialog did not display at all (the checkboxes were selected), the 'Baselines dialog displays.

Processing

Click on the required Baseline and on the Show Differences button. The 'Baseline Diagram Compare' dialog displays. Refer to the *Results* section and the *Options* table.

Results

The 'Baseline Diagram Compare' dialog shows the elements that have been changed on the diagram, and what kind of change was made (examine the 'Status' field).

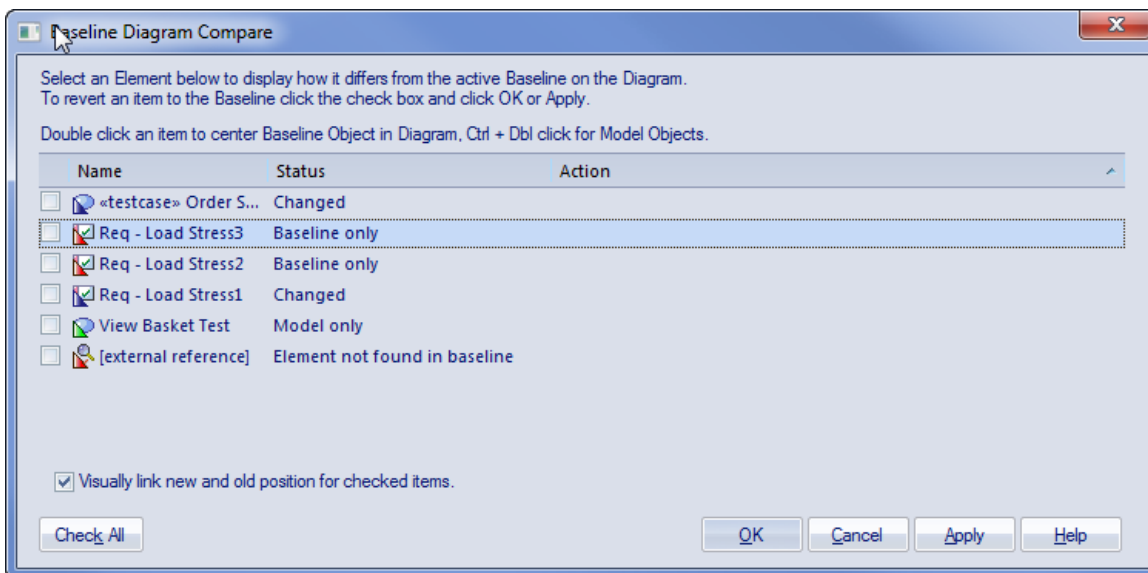

As you select elements on the dialog, images are shown on the diagram itself to indicate where the changed element was and what kind of change it underwent.

Options

Option	Detail
Select (click	The 'Status' column indicates whether the

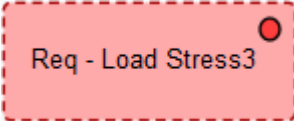
on) name of element	<p>element has been:</p> <ul style="list-style-type: none">• Moved or re-sized (Changed)• Deleted from the diagram (Baseline only)• Added to the diagram since the Baseline was captured (Model only), or• Deleted from its parent external Package, and there is no record in the current Baseline (because the Baseline is only for the current diagram's parent Package) <p>This diagram-linked element has been deleted from the model. The element might be found in a different baseline either in a parent Package baseline or a different Package baseline outside of the current Package. If the external referenced element is restored to the model, the visual comparison will be able to resolve the missing diagram object in the current baseline.</p> <p>When an item is selected, the corresponding element on the diagram is highlighted as shown:</p> <ul style="list-style-type: none">• Deleted from the diagram  <ul style="list-style-type: none">• Added to the diagram
---------------------	---

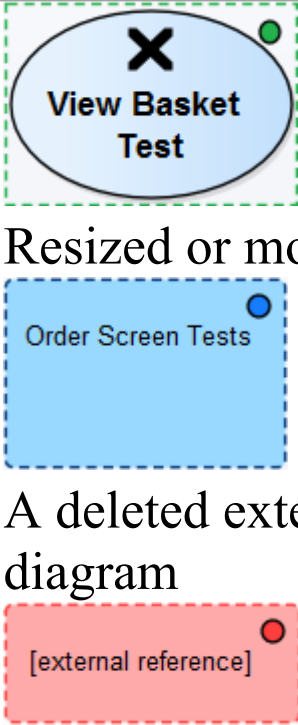
	 <ul style="list-style-type: none"> • Resized or moved to a new position • A deleted external element on the diagram <p>The highlighted element on the diagram is marked with a colored dot, as shown, to indicate that it is in focus.</p>
<p>Position the diagram to show the selected element</p>	<p>To scroll the diagram so that you can see the original (Baseline) position of an element, double-click on the item in the list.</p> <p>To scroll the diagram so that you can see the current (model) position of the element, press and hold Ctrl while you double-click on the item.</p>
<p>Leave the changes in the item as they are</p>	<p>Ensure that the checkbox against the item is not selected.</p> <p>Click on the OK button.</p>

Roll the changes back to the Baseline position

Click on the checkbox against each required item (or click on the Check All button to select every item).
The 'Action' column displays the action required to roll each element's relationship to the diagram back to the Baseline relationship, and on the diagram the selected elements are represented as shown:

- This deleted element will be restored

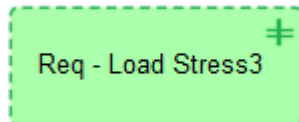

- This added element will be removed

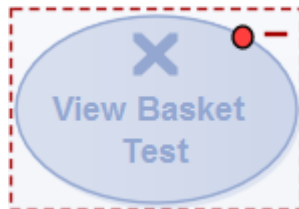

- This resized/repositioned element will be put back in its original position

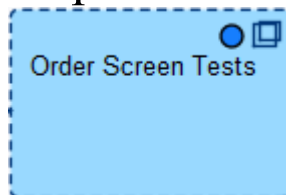

- This element from another Package, deleted from the diagram, cannot be restored from this Baseline

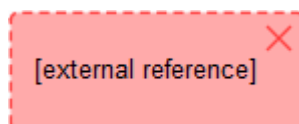

The comparison automatically shows a

blue direction arrow for each reposition or resize that has been checked. For a heavily edited diagram this might be confusing. However, you can hide the arrow for all elements except the one currently in focus; to do this:

- Deselect the 'Visually link new and old position for checked items' checkbox

To roll back the changes for all items for which a checkbox is selected:

- Click on the Apply button

Notes

- Diagram Baseline facilities are available in the Corporate, Unified and Ultimate Editions of Enterprise Architect

Revert Model to a Baseline

You can return any part of a model to the content stored in the Baseline. This is a simple process of selecting the item in the Baseline comparison tool and using the 'Merge to Model' toolbar icon.

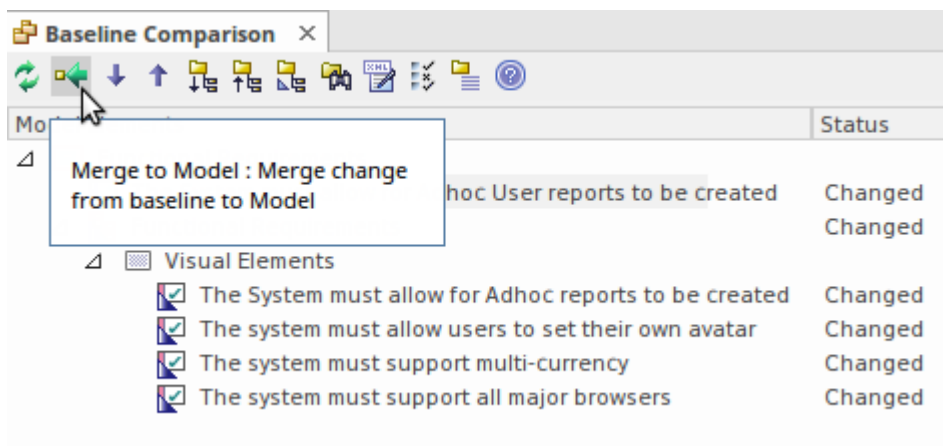

The 'Merge to Model' option for a selected Requirement element.

The 'Merge to Model' option is useful when you or your team identify unwanted changes that have been made to the model since the Baseline was created. There could be items such as elements, Features, Tagged Values, connectors and diagram objects that have been:

- Deleted
- Modified, or
- Created

You will be warned that this option is not reversible, and if changes are merged from the Baseline to the model the changes to the model will be lost. Note that it is not possible

to merge model changes to a Baseline, as the Baseline is a snapshot and cannot be altered.

Manage Baselines

Baselines are snapshots of a repository Package taken at a point in time. These snapshots are stored in a format called XMI, which is an XML format. These files must be stored so that they can be recalled and used for comparisons at a future time. There are two primary places to store Baselines:

- In the current repository - this is the default location
- In a Reusable Asset Service - a Reusable Asset Service needs to be nominated as the location

Baselines are by default stored in the repository so when, for example, you create a Baseline of a Requirements Package at a given milestone, the 'snapshot' would by default be stored in the same model as the Requirements. This type of storage is practical and sufficient for small, isolated project teams, but for larger teams and endeavors, Enterprise Architect provides some mechanisms to store the Baselines as reusable and universally accessible snapshots available to any project or organizational team, anywhere in the world. This reusable storage is particularly useful in this age of innovation and agility, where geographically independent teams need to share information and reuse existing assets at Internet speed. The facility uses the Reusable Asset Server (RAS), which is Cloud-based (including on the home premises) and provides sophisticated mechanisms to manage these valuable corporate assets.

Management of the Baselines differs depending on the option selected. A librarian or administrator typically

decides which option is most appropriate for a given repository and team. Factors such as whether the Baselines need to be made available to a distributed audience and whether dependency analysis is required would be considerations in this decision.

Access

Ribbon	Settings > Model > Options > Baseline
--------	---------------------------------------

Specify Reusable Assert Server for Baselines

To store baselines in a Reusable Asset Server, you need to define this on the 'Baseline' page of the 'Manage Model Options' dialog, where you specify Cloud connection and storage details and options.

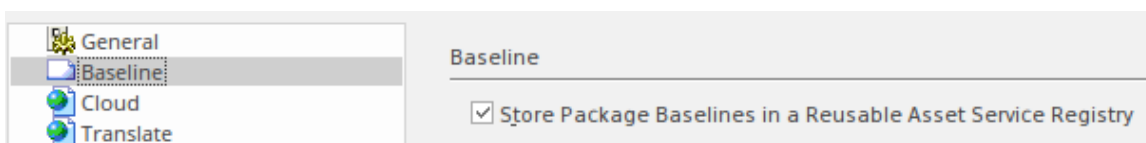

Manage Baselines in Model

When you manage baselines in the model, all of the Baseline features are available through the Manage Baselines window. As discussed in a prior topic, this is the default way to work with baselines and the files themselves are stored in compressed format inside the repository. This ensures these baseline snapshots are available to all model users who have the requisite permissions to manage the baselines where security has been enabled.

Storing the baselines in the repository is much more immediate and convenient, and is suitable for small teams and situations where baselines are used in a cohesive team environment. If these baselines are important assets that need to be shared or managed by wider communities of users, the Reusable Asset Server can be used to provide access to distributed users.

Access

Ribbon	Design > Package > Manage > Manage Baselines
Keyboard Shortcuts	Ctrl+Alt+B

Baseline Management

Create, select and process Baselines using the 'Package Baselines' dialog.

Option	Action
Current Baselines For Package: <Name>	<p>Review the Baselines for the current model branch, listed by version reference with the highest alphabetical/numerical value at the top.</p> <p>If an entry is longer than the display area, a horizontal scroll bar displays at the bottom of the panel; use this to scroll to the text that is not shown.</p>
Show Differences	<p>Run the Compare utility on the selected Baseline and the current model branch or diagram, to display the differences between the two.</p>
Restore to Baseline	<p>Completely restore the model branch from the selected Baseline.</p>
New Baseline	<p>Create a new Baseline.</p>
Delete Selected	<p>Delete the selected Baseline.</p>

Load Other Baselines	<p>Display a drop-down menu that enables you to load Baselines from another model, in either a project file or a DBMS repository.</p> <ul style="list-style-type: none"> • For project files, a browser displays; locate the required project file • For DBMS repositories, the Windows 'Data Link Properties' dialog displays; select the data provider and click on the OK button to display the 'Select Data Source' dialog, from which you select the required project <p>In either case, the <i>Connected To:</i> message at the bottom of the 'Package Baselines' dialog changes to the name of the alternative model.</p> <p>To return the dialog to the original project, select the third option on the drop down list: 'Load From Selected Package'.</p>
Import File	<p>Import an XML 1.1 file from the file system as a new Baseline for this current model branch.</p>
Export File	<p>Export the selected Baseline to an XML file.</p>
Compare Model to File	<p>Compare the selected model branch with an XML 1.1 file in the file management</p>

	system; a browser displays, which you use to locate the file.
Options	Set filters to make the comparison more specific.

Notes

- Package Baseline facilities are available in the Corporate, Unified and Ultimate Editions of Enterprise Architect

Manage Baselines in Reusable Asset Service

When you manage Baselines through the Reusable Asset Server (RAS) all of the Baseline features are available but in addition there are a range of other features only available when using RAS baselines. As discussed in a prior topic the baselines are available to a much wider audience, including other teams and departments, customers, standards authorities, partners, consultants, testers and more, all protected by robust industry standard security. Baselines stored in the RAS are more transparent and searchable, making it easier to understand and work with the content they contain.

Enterprise Architect provides a range of facilities for working with and managing Baselines stored in a Reusable Asset Service Registry, using the 'Reusable Asset Service - Baseline' view. When you open this view, the 'Baseline Browser' tab immediately displays a list of the Baselines available for the Package that is currently selected in the Browser window. You can review and use these Baselines using the context menu and buttons on the tab.

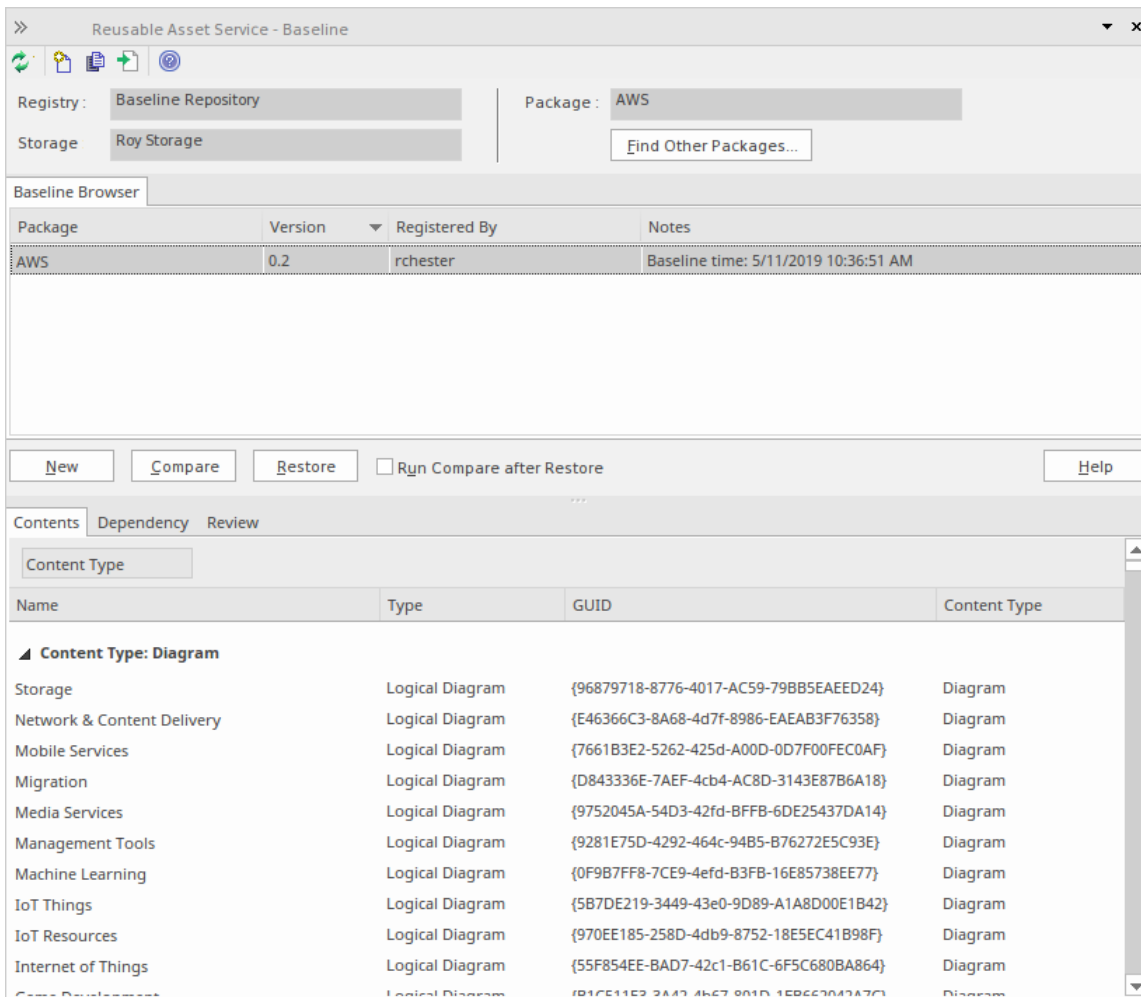

You can review the contents of the selected Baseline using the tabs in the lower half of the 'Reusable Asset Service - Baseline' view, underneath the 'Baseline Browser' tab.

If you have left the 'Baseline Browser' open for a while, there is a possibility that the contents of the Storage in Registry might have changed. Click on the  icon in the 'Reusable Asset Service - Baseline' toolbar to refresh the Browser with the latest contents of the Storage.

Note: To store Baselines in a Reusable Asset Service Registry, select the 'Baseline' page in the 'Manage Model Options' dialog and configure the Cloud connection to the Registry, then select or create the Storage in which to store all the Baselines for the Packages in the model.

Access



Ribbon	Design > Package > Manage > Manage Baselines
Keyboard Shortcuts	Ctrl+Alt+B

Baseline Management

Create, select and process Baselines using the 'Reusable Asset Service - Baseline' view.

Option	Action
Registry	Displays the Registry name, as specified on the 'Baseline' page of the 'Manage Model Options' dialog.
Storage	Displays the Storage name, as defined on the 'Baseline' page of the 'Manage Model Options' dialog.
Package	Displays the name of the Package currently selected in the Browser window.

<p>Find Other Packages</p>	<p>Click on this button to open the 'Reusable Asset Services' view, displaying the Storage and its full contents; that is, all Packages with Baselines, and any other Packages held in the Storage.</p>
<p>Baseline Browser</p>	<p>Lists the Baselines, if any, for the current Package. The Baselines are listed by version - with the highest alphabetical or numerical value at the top.</p> <p>When you select a Baseline in the Browser, details of the Baseline are displayed in the tabs beneath the 'Baseline Browser' tab.</p> <p>Note: You can right-click on the column headings and select the 'Toggle Filter Bar' option to show or hide the Filter Bar on the display. If you show the Filter Bar, type in the appropriate characters to list only those Baselines that have that string of characters in the value in the corresponding column.</p>
<p>New</p>	<p>Click on this button to create a new Baseline.</p> <p>Note: You can also click on the  icon in the 'Reusable Asset Service - Baseline' toolbar to create a new Baseline.</p>

Compare	<p>Click on this button to run the Compare utility on the selected Baseline and the current Package, to display any differences between the two. The results of the comparison are displayed on the 'Comparison Utility' view.</p> <p>Note:</p> <p>You can also run the Compare utility by:</p> <ul style="list-style-type: none">• Clicking on the  icon in the 'Reusable Asset Service - Baseline' toolbar or• Right-clicking on the Baseline name and selecting the 'Compare' context menu option
Restore	<p>Click on this button to completely restore the Package in the model from the selected Baseline.</p> <p>Note:</p> <p>You can also restore the Package from the selected Baseline by:</p> <ul style="list-style-type: none">• Clicking on the  icon in the 'Reusable Asset Service - Baseline' toolbar• Right-clicking on the Baseline name and selecting the 'Restore' context menu option
Run	Check this option to automatically run the

Compare after Restore	Compare utility once the Package is completely restored from the selected Baseline.
-----------------------	---

Notes

- The Package Baseline facilities are available in the Corporate, Unified and Ultimate Editions of Enterprise Architect
- Reusable Asset Service Registry details must be configured in the 'Baseline' page of the 'Manage Model Options' dialog
- If a 'Read-Only Access' password is entered for the Storage in the 'Baseline' page of the 'Manage Model Options' dialog, you will not be able to create new Baselines in the 'Reusable Asset Service - Baseline' view as the 'New' button will be disabled
- If security is enabled, you must have 'Baselines - Restore model' permission to restore a Package from the selected Baseline

Baseline Contents

In the 'Reusable Asset Service - Baseline' view, when you select a Baseline in the 'Baseline Browser' tab, the three tabs in the lower half of the view are updated with information on the Baseline. The 'Contents' tab lists the diagrams and elements (including any child Packages) held in the selected Baseline, listing the two types of object separately. You can organize the information within a column into alphabetical or reverse-alphabetical order for ease of reference, and use the Filter bar to filter the display to show only items with values containing specific characters or digits.

Access

Open the 'Reusable Asset Service - Baseline' view using one of the methods outlined here.

Select a Baseline in the 'Baseline Browser' tab, then click on the 'Contents' tab to display the contents of that Baseline.

Ribbon	Design > Package > Manage > Manage Baselines
Keyboard Shortcuts	Ctrl+Alt+B

Review Baseline Contents

Option	Detail
Content Type	Click on this button to toggle between listing the Baseline diagrams first and listing the Baseline elements first.
Toggle Filter Bar	Right-click on the column headings and select this option to show or hide the Filter Bar on the display.
(filter bar fields)	Type in the appropriate characters to list only elements and diagrams that have that string of characters in the values in the corresponding column.
Content Type: Diagram Content Type: Element	These are the headers for the two types of object listed in this tab. Click on the appropriate white or black arrow head to hide or show the list of diagrams or elements under the heading.
Name	Displays the name of the element or diagram available in the Baseline.
Type	Displays the type of the element or diagram, such as Use Case or Use Case

	diagram.
GUID	Displays the Global Unique Identifier of the element or diagram.
Content Type	Displays the object type of the item - Element or Diagram.
Find in Project Browser	Right-click on an element or diagram line and select this option to see if the element or diagram also exists in your model and, if it does, to highlight it in the Browser window.
View Diagram	Right-click on a diagram name and select this option to display the diagram within a labeled frame, as an image. Alternatively, double-click on the diagram name.

Baseline Dependencies

When you select a Baseline on the 'Baseline Browser' tab, the three tabs in the lower half of the 'Reusable Asset Service - Baseline' view are updated with information from the Baseline. A Package might contain elements and diagrams that have relationships with objects in other Packages. When you generate a Baseline for that Package, the name and Global Unique Identifier (GUID) of each Package containing these 'external' objects will be stored along with the Baseline and displayed in the 'Dependency' tab.

Note that Package A depends on Package B if any of these constructs (or their Tagged Values) in Package A reference elements in Package B:

- Elements
- Attributes
- Operations
- Operation Parameters
- Diagrams
- Connectors

Access

Open the 'Reusable Asset Service - Baseline' view using one of the methods outlined here.

Select a Baseline on the 'Baseline Browser' tab, then click on the 'Dependency' tab to display a list of dependencies for

that Baseline.

Ribbon	Design > Package > Manage > Manage Baselines
Keyboard Shortcuts	Ctrl+Alt+B

Check Baseline Dependencies

Option	Detail
Package	Displays the name of the related Package.
GUID	Displays the Global Unique Identifier of the related Package.
Find in Registry	<p>Right-click on the 'Package' line and select this option to see if the Package exists in the Registry.</p> <p>Selecting this option will :</p> <ul style="list-style-type: none"> • Open the 'Reusable Asset Service' view • Connect to the Registry and load the Storage that is currently selected in the 'Reusable Asset Service - Baseline' view

	<ul style="list-style-type: none">• Open the 'Search Registry' dialog• Search for the selected Package using its GUID and display the results of the search, if any
Find in Project Browser	Right-click on the 'Package' line and select this option to see if the Package also exists in your model and, if it does, to highlight it in the Browser window.
Copy Package Name to Clipboard	Right-click on the 'Package' line and select this option to copy the Package name to the clipboard.
Copy Package GUID to Clipboard	Right-click on the 'Package' line and select this option to copy the Package GUID to the clipboard.

Notes

- The Name and Global Unique Identifier (GUID) of a Package containing 'external' objects will not be stored with the Baselines if the option 'Check Package dependency when creating Baseline' is disabled on the 'Baseline' page of the 'Manage Model Options' dialog

Add Review Comments

When you select a Baseline on the 'Baseline Browser' tab, the three tabs in the lower half of the 'Reusable Asset Service - Baseline' view are updated with information from the Baseline. For any Baseline, you can add individual review comments on any aspect of the Baseline. These comments provide a permanent record on the Baseline - once they have been saved they cannot be edited or deleted. Each comment is attributed to the ID of the user who entered it, and is date stamped.

Access

Open the 'Reusable Asset Service - Baseline' view using one of the methods outlined here.

Select a Baseline on the 'Baseline Browser' tab, then click on the 'Review' tab to display the review comments of that Baseline.

Ribbon	Design > Package > Manage > Manage Baselines
Keyboard Shortcuts	Ctrl+Alt+B

Actions

Action	Detail
Review Existing Comments	<p>If there appears to be a longer comment than can be shown in the 'Review' tab, click on it. The full text displays in the 'Comments' field in the lower panel.</p>
Create Comments	<p>Click on the New button and start typing your comment on the Package in the 'Comments' field. You can delete and edit text as you type.</p> <p>When you have finished writing your comment, click on the Save button. Your comment, preceded by your user ID and the current date, is displayed in the 'Review' panel.</p> <p>Once you have saved your comment, you cannot edit or delete it.</p>

More Information

Baselines in Enterprise Architect serve as snapshots of specific parts of the repository at a particular moment in time. They are used for later comparison and restoration if needed.

When a Baseline is created, it captures a snapshot of a model Package and its contents at that specific point in time. This allows users to compare the current state of the model with the baseline snapshot and revert to the previous (baselined) state if necessary. Baselines can be created at the Package level and can include child Packages. Users can baseline any number of Packages, and a Package can be baselined multiple times, typically at significant project milestones.

By default, Baselines are conveniently stored within the repository, accessible to users with the necessary security privileges. Alternatively, Baselines can be stored in a Cloud-based Reusable Asset Service for broader accessibility and collaboration.

Edition Information

- Package Baseline facilities are available in the Corporate, Unified and Ultimate Editions of Enterprise Architect
- The Compare utility (used to compare an exported

Package with a model Package) is available in the Professional Edition of Enterprise Architect, as well as in the Corporate, Unified and Ultimate Editions

- The Enterprise Architect Corporate, Unified and Ultimate Editions provide another facility, Auditing, which you can switch on to perform continuous monitoring of changes across the project; you can dovetail your use of each facility to meet the range of your change management requirements

Considerations

Baselines are based on the Global Unique Identifier (GUID) of a particular Package:

- Enterprise Architect checks for that GUID as the root element within the XML document being used as a Baseline
- When you export a Package to XML, the Package you export is the root element; likewise when you create a Baseline, the current Package is the root Package of the XML Baseline
- When you save information in a Version Control system, the current Version Controlled Package is again the root Package of the document
- It is not useful to create a Baseline by importing an XMI Package file created by Version Controlling a Package that itself contains Version Controlled child Packages; that type of XMI Package file contains stubs for the child

Packages, not full information on the child Packages and elements

- If a Package under Version Control forms part of a Baseline, and that Package is checked in to the model, you cannot merge the original data from the Baseline into that Package

XML files must be in the same format used by the Baseline engine - currently the UML 1.3 XMI 1.1 format (plus Enterprise Architect extensions), which contains all the information necessary to reconstruct a UML model, even a UML 2.x model.

Notes

- If a Package under Version Control forms part of a Baseline, and that Package is checked in to the model, you cannot merge the original data from the Baseline into that Package
- You can also obtain a snapshot of selected items in the model, using the Model Views facility; this facility enables you to automatically generate the snapshot at intervals and, if there are changes in the items collected by the defined search, to trigger a notification to you of such changes, which enables you to monitor workflow and other events of concern to you
- If security is enabled you must have 'Baselines - Manage' permission to create, import and delete Baselines, and 'Baselines - Restore' permission to merge data from a Baseline; security permissions are not required to select

an existing Baseline and perform a comparison with the model

Reusable Asset Service (RAS)

Within a large organization, groups of users can be separated by geographical distance and be on different networks. This can make it difficult to share common data, standards and modeling structures, without the complexity of using external Version Control tools or manually distributing XMI files between projects. Enterprise Architect supports a Reusable Asset Service (RAS) that provides a simple and convenient mechanism for modelers to distribute or download reusable model structures, information, as well as corporate directives and standards. The shared repository is accessible via a Pro Cloud Server connection, making it accessible for distributed teams. The person who sets up the reusable data can retain governance of the resource or asset, whilst users of the service can easily review the currency of the information and download the latest versions into their models or file folders.

The RAS gives distributed teams convenient access to a single 'source of truth' for shared data, including project milestones, architectural frameworks and industry standards.

Reusable Assets

A Reusable Asset Storage is contained in a Pro Cloud Server repository.

Reusable Assets can consist of:

- Packages containing elements, diagrams and structures (as drawn from any point within the Browser window), and

- Learning Center topics
- Files in a range of text, code and graphic formats, including .qea and .eap files

An asset can be, for example:

- A common Class library or framework
- The Baselines for a set of Packages or of the whole model
- A set of common Requirements or Use Cases
- A draft specification document
- Marketing collateral

Storage Structure and Use

A Reusable Assets registry contains any number of Storages, which can either be left unprotected for any user to create, or change-restricted by an Administrator password. Each Storage can contain any number of Asset Packages holding modeling structures, and files containing textual or graphical information and data. When a user creates a Storage, they can protect the contents from being updated in the Registry or downloaded into a model, using password protection defined by that user.

For each Package, the RAS automatically identifies the:

- Version of the Package held in the registry
- Diagrams and elements (including child Package elements) contained by the Asset Package
- Dependencies on parent Packages of any external elements that the Asset Package references

- Dependencies on MDG Technologies

Features

Here is an overview of the features available in the RAS.

Feature	Description
Register Assets	<p>The assets that can be created include:</p> <ul style="list-style-type: none"> • Packages - including diagrams and subordinate Packages • Baseline Packages • Files • Learning Center contents.
Browse Assets	<p>Any user, regardless of password protection, can freely browse and identify the contents of a Package held in a Storage - including displaying the diagrams - without importing the material into a model.</p>
Import Content	<p>Any user with access to the Pro Cloud Server repository and a password (if required), can import an Asset into their repository.</p>
Dependencies	<p>Any dependencies within a stored Package are viewable, providing a quick</p>

	means to visually see what the Asset requires.
View Diagrams	Any diagrams set in an Asset are logged and can be viewed providing a quick means to check and visually compare the Asset diagrams against updates to diagrams in the current model.
Compare	Where a user that has imported an Asset Package into their model, they can compare their model Package against any version of the Asset Package, to check for and assess any differences between them.
Required Technologies	For a Package Asset that has specific Technologies these are displayed for clarification of what is required on importing the Asset.
Reviews	Reviews and comments can be posted against a Package.

Set Up the Asset Service

The process of setting up assets and files in the Reusable Asset Service has a number of simple stages, typically:

- Identify the Registry
- Create the Storages, including copying an existing Storage as a template for a new one
- Set password protection on each Storage
- Register the Asset Packages and Storage Files, and update them as necessary

Prerequisites

As a Reusable Asset Service is stored in a Pro Cloud Server repository, there must be a Pro Cloud Server (PCS) operating and a repository configured and enabled on this PCS.

Access

Ribbon	Publish > Model Exchange > Reusable Assets
--------	--

Identify the Repository

A Reusable Asset Registry is contained in a PCS based repository that is typically configured by a System Administrator. If you have access to an existing PCS repository then the connection details for that can be used for creating Reusable Asset Storage. Otherwise, if a new repository needs to be created by a System Administrator, they will provide the repository connection details for you to use.

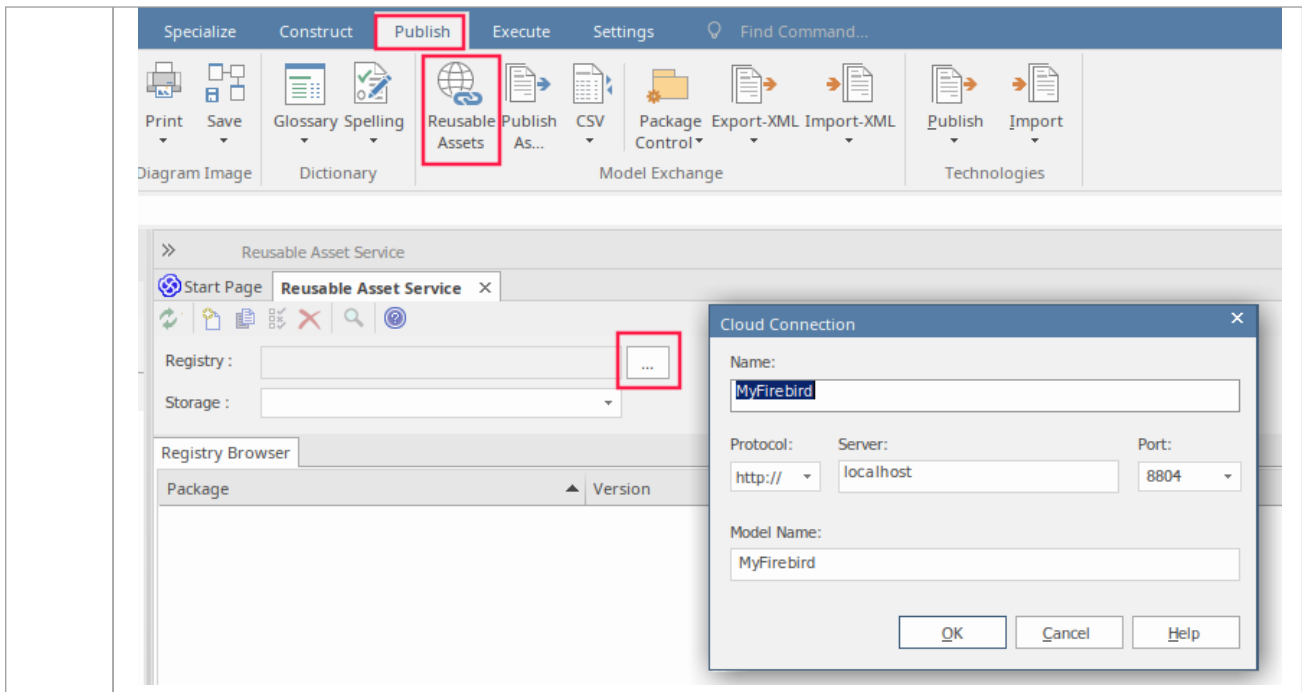

Step	Action
1	<p>If a new repository is required, then the System Administrator creates a PCS based Repository to act as the Reusable Asset Registry and then provides you with the connection details like server and model name.</p> <p>If a PCS repository already exists and you have access to it, then proceed to step 2.</p>
2	<p>In the Reusable Asset Service view, click on the  button to the right of the 'Registry' field.</p> <p>The 'Cloud Connection' dialog displays.</p> <p>In the Cloud Connection dialog, type in the connection details of the PCS repository:</p>



3 Click on the OK button.
The 'Registry' field now shows the Cloud Connection name.

4 If required for security, set up a Registry Password.

Toolbar Options

Option	Description
	Option for creating a new storage as a container within the Registry for holding related assets and files.
	Used for copying a Storage as the basis

	for creating another Storage.
	Option for updating the Storage details.
	Option for deleting a storage's entire contents.

Set Up Registry Password

As a System Administrator, you can password-protect the Registry to prevent users from modifying the Registry; that is, restrict users from performing top-level activities such as creating, modifying and deleting Storages. Once you have set password protection, only those users who have a valid Administrator password can modify the Registry.

You can also change the password at regular intervals, for added security.

Access

In order to set the Registry Administrator password:

- In Enterprise Architect, open the Cloud model that is designated as the RAS Registry
- Open the RAS window (Publish > Model Exchange > Reusable Assets)
- The Set Administrator Password button is displayed next to the 'Registry' field

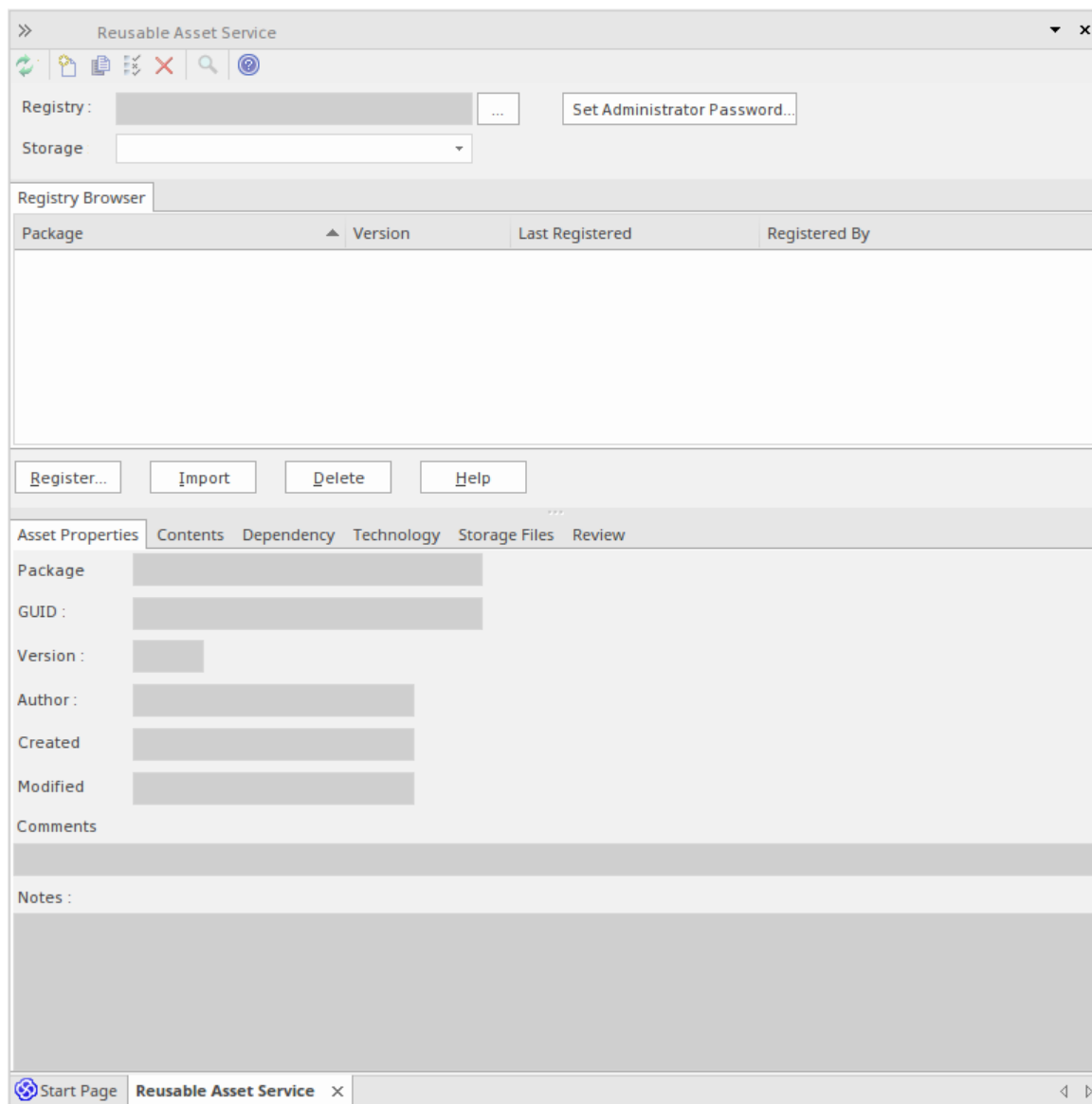

- Click on this button to display the 'Set Administrator Password' dialog

Set the Administrator Password

Option	Detail
Enter old	Disabled if no password exists for the

password	Registry. If Registry has a current password, type it in to this field.
New password	Type in the new Administrator password.
Retype new	Type in the new Administrator password, for confirmation.
OK	Click on this button to set the password and close the dialog.
Cancel	Click on this button to abort the changes and close the dialog.

Notes

- To remove password protection from the Registry, complete the 'Enter old password' field but leave the 'New password' and 'Retype new' fields blank
- If a Storage has a 'Complete Access' password, then you can use either the Administrator password or the 'Complete Access' password to modify the Storage

Creating Asset Storages

A Storage is a container within the Registry, holding related assets and files. There can be several Storages in the Registry, to support the different areas of work or purposes that your organization might define.

Create Storages

When creating a new Storage you have the option to set what type of storage this is to be. The Storage types available include:

- Model Package - contains Asset Packages and/or Files
- Learning Center Library - Learning Center Library content
- Reference Data Library - Enterprise Architect Reference Data Library
- Source Code Library - can be populated with any zipped files.

Step	Action
1	Click on the  icon in the Reusable Asset Service toolbar.
2	If necessary, enter the Administration password that enables update access to the Registry. Click on the OK button.

The 'New Storage' dialog displays.

The screenshot shows the 'New Storage' dialog box. It features a title bar with the text 'New Storage' and a close button. The main area contains the following elements:

- Name :** A text input field.
- Content :** A dropdown menu currently showing 'Model Package'.
- Status :** A dropdown menu currently showing 'Draft'.
- Storage Access Password** section:
 - Complete Access :** Includes a 'Complete Access' text input field and a 'Confirm Password' text input field. Below them is the text: 'Set this password to allow access to the Storage for registering, retrieving and deleting packages.'
 - Read-Only Access :** Includes a 'Read-Only Access' text input field and a 'Confirm Password' text input field. Below them is the text: 'Set this password to restrict access to the Storage for retrieving packages only.'

At the bottom of the dialog are three buttons: 'OK', 'Cancel', and 'Help'.

3 In the 'Name' field, type a name that indicates the purpose or content of the Storage.

4 In the 'Content' field, select:

- 'Model Package' if the Storage should contain Asset Packages and/or Files
- 'Learning Center Library' if the Storage should contain only Enterprise Architect Learning Center Library files - this Storage can be populated only with Library files and not with Asset Packages
- 'Reference Data Library' if the Storage should contain only Enterprise Architect Reference Data Library files - this Storage can be populated only with Library files and not with Asset Packages

	<ul style="list-style-type: none"> • 'Source Code Library' if the Storage should contain only Source Code Library files - this Storage can be populated only with Library files and not with Asset Packages
5	<p>If you have selected 'Model Package' in the 'Content' field, then in the 'Status' field select:</p> <ul style="list-style-type: none"> • 'Draft' if you intend to make significant changes to the content of the Storage, such as populating it with assets and/or files; you can also overwrite existing Packages or files in the Storage • 'Complete' if the Storage is ready for use; you cannot overwrite any Packages or files in the Storage, although you can delete Packages and files and add new ones <p>You can modify a 'Model Package' Storage at a later time, and change this 'Status' setting (see the <i>Change Storage Details</i> section in this topic).</p> <p>Storage whose Content is 'Learning Center Library', 'Reference Data Library' or 'Source Code Library' will always be of 'Draft' Status - you can overwrite existing Library files in these Storages.</p>
6	<p>If you want to set Storage Access passwords on this Storage, click on the checkbox against one or both password types, and provide and confirm the 'Complete Access' and/or 'Read-Only Access' passwords.</p> <p>For more details, see the <i>Storage Access Passwords</i></p>

	section in this topic.
7	<p>Click on the OK button.</p> <p>A prompt displays for you to confirm the creation of the Storage, with the type of access you have set on the Storage.</p>
8	<p>Click on the Yes button.</p> <p>A confirmation message displays; click on the OK button.</p> <p>The name of the new Storage displays in the 'Storage' field.</p>

Storage Access Passwords

The Registry can be protected by a Registry password, so that only the Administrator can create and modify Storages. If no Registry password is set, a second level of password protection can be applied.

The owner of a Storage can apply password protection to restrict users in processing and modifying the contents of the Storage either intentionally or unintentionally. Password protection can be applied at two levels:

- Complete Access - users enter their password and can modify or delete the Storage itself, and within the Storage can register, update and delete Packages and files in the Registry, view Packages and import assets into their

models

- Read-Only Access - users enter their password and can import assets into their models

You set the 'Complete Access' password before you set the 'Read-Only Access' password.

If password protection is set and a user has no password, they can only view the contents of the Storage. If no password protection is set, all users can freely access and modify the Storage and its contents.

You set the passwords on each Storage as you create that Storage, using the 'New Storage' dialog. Once the Storage has been created, you can change or remove an existing password using the 'Modify Storage Access' dialog, but you cannot add a password.

If a Storage is password protected, the system displays a prompt for the password when the user begins to:

- Change or delete a password on the Storage
- Copy the Storage to create a new Storage
- Delete the Storage
- Register a Package or file in the Storage
- Import a Package, file or Technology from the Storage
- Delete a Package or file from the Storage
- Compare an Asset Package with a Package in the model

The system displays the password prompt when any of those operations is performed for the first time after the user:

- Connects to a Registry
- Reloads the Registry Browser

- Selects a Storage in the 'Storage' field in the Reusable Asset Services view

If the user enters the correct password and therefore establishes their credentials, the system does not display a password prompt again for any valid operation that user performs until they:

- Select a different Storage in the 'Storage' field in the Reusable Asset Services view or
- Reload the Registry Browser from the Registry

Register Assets and Files

Whilst a Storage exists and, if the Storage is under password protection, and you have the 'Complete Access' password, you can register Packages from a model and files from your system as assets in that Storage. If the Asset Package was developed using one or more MDG Technologies, you can optionally register those technologies in the Storage as well. See the *Register New Assets* Help topic.

Copying Asset Storages

It is possible to copy a Storage as the basis for creating another Storage, for example if you want to use the same set of assets in the context of a larger set for a different department, work area or development phase.

Note: It is not possible to change the 'Content' of a Storage nor is it possible to change 'Status' of a 'Learning Center Library', 'Reference Data Library' or 'Source Code Library' Storage.

Copy Storages

To copy a Storage, follow these steps.

Step	Action
1	In the 'Storage' field, select the Storage to be copied.
2	Click on the  icon in the Reusable Asset Service toolbar.
3	If necessary, enter the Administrator password or your 'Complete Access' password and click on the OK button. The 'Save Storage As' dialog displays.

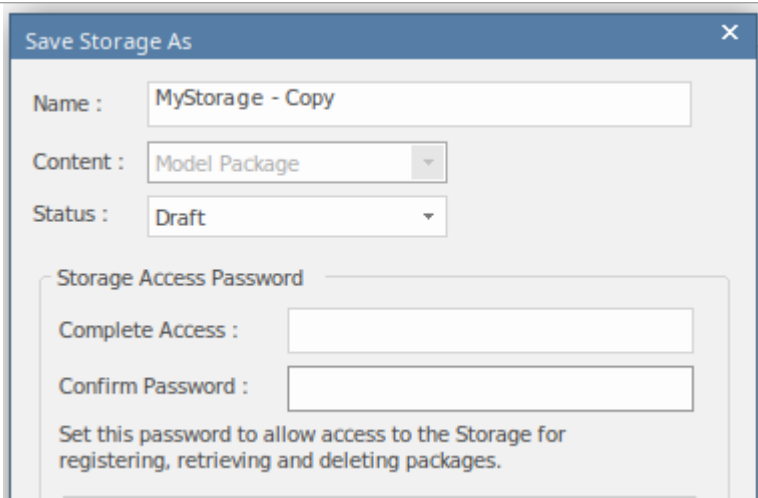

4 In the 'Name' field, type a name that indicates the purpose or content of the new Storage.

5 If 'Model Package' is selected in the 'Content' field, then in the 'Status' field select:

- 'Draft' if you intend to make significant changes to the content of the Storage, such as populating it with assets and/or files; you can overwrite existing Packages or files in the Storage
- 'Complete' if the Storage is ready for use; you cannot overwrite any Packages or files in the Storage, although you can delete Packages and files and add new ones

You can modify a 'Model Package' Storage at a later time, and change this 'Status' setting (see the *Change Storage Details* section in this topic).

6 If you want to set Storage Access Passwords on this Storage, click on the checkbox against one or both password types, and provide and confirm the

	'Complete Access' and/or 'Read-Only Access' passwords.
7	<p>Click on the OK button.</p> <p>A prompt displays for you to confirm the creation of the Storage, with the type of access you have set on the Storage.</p>
8	<p>Click on the Yes button.</p> <p>A confirmation message displays; click on the OK button.</p> <p>The name of the new Storage displays in the 'Storage' field.</p>

Change Storage Details

After you have set up a Storage, you can update it at a later stage to:

- Change the status of a 'Model Package' Storage
- Change one or both of the existing 'Complete Access' and 'Read-Only' Access passwords
- Delete one or both of the passwords

Note: there are restrictions in that:

- It is not possible to add a password where one has not previously been set.
- You cannot change or delete passwords unless you have the 'Complete Access' password yourself.
- It is not possible to change the 'Content' of a Storage nor is it possible to change 'Status' of a 'Learning Center Library', 'Reference Data Library' or 'Source Code Library' Storage.

Process

Step	Action
1	On the Reusable Asset Service view, in the 'Storage' field click on the drop-down arrow and select the Storage to update.

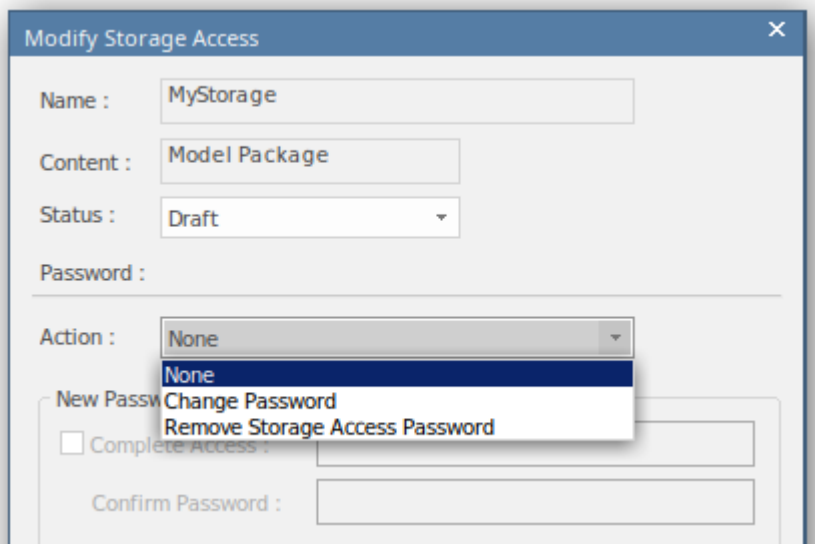
<p>2</p>	<p>Click on the  icon in the Reusable Asset Service view toolbar.</p>
<p>3</p>	<p>If necessary, enter the Administrator password or your 'Complete Access' password and click on the OK button.</p> <p>The 'Modify Storage Access' dialog displays.</p> 
<p>4</p>	<p>If 'Model Package' is selected in the 'Content' field, then in the 'Status' field select:</p> <ul style="list-style-type: none"> • 'Complete' if the Storage has now been set up and is ready for use; you cannot overwrite any Packages or files in the Storage, although you can delete them and add new Packages and files • 'Draft' if you intend to make significant changes to the content of the Storage; you can overwrite existing Packages or files
<p>5</p>	<p>The 'Action' field defaults to 'None', to indicate no changes to the passwords. If you are changing or</p>

deleting the passwords, click on the drop-down field and select:

- 'Change Password' to enable both password type fields ready for editing
- 'Remove Storage Access Password' to simply delete the 'Complete Access' password altogether
- 'Remove Read-Only Access Password' to simply delete the 'Read-Only Access' password altogether

6 If you have selected the 'Change Password' option, select the appropriate password checkbox or both checkboxes, and type in the new password(s). Re-type the password(s) in the 'Confirm Password' field(s).

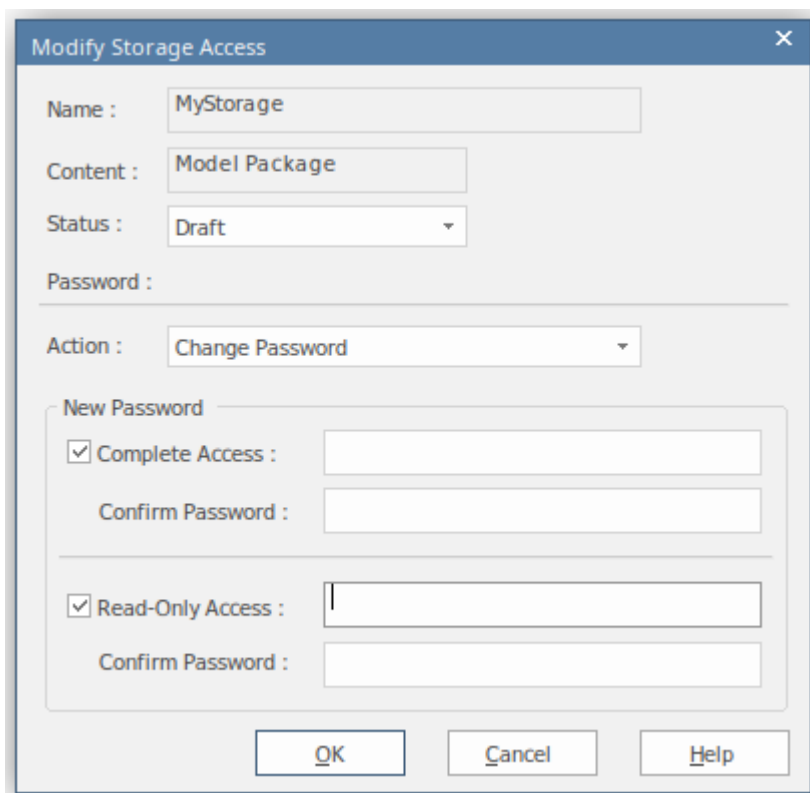

7 Click on the OK button to save your changes and

	close the 'Modify Storage Access' dialog.
--	---

Delete a Storage

If a Storage has been created by mistake, or is no longer necessary in the Registry, you can delete it and its entire contents of Package and files in one action.

Process

Step	Action
1	On the Reusable Asset Service view, in the 'Storage' field click on the drop-down arrow and select the Storage to delete.
2	Click on the  icon in the Reusable Asset Service view toolbar. A prompt displays to confirm the deletion.
3	Click on the Yes button. If necessary, enter the Administrator password or your 'Complete Access' password and click on the OK button. A message displays to confirm that the Storage has been deleted.
4	Click on the OK button to clear the message. The Storage and its contents are cleared from the

	Registry.
--	-----------

Connect to the Asset Service

The Reusable Asset Service provides model structures and documents to you from one or more registries on remote systems. You access these registries through a Pro Cloud Server connection to the appropriate server. The connection details should be provided to you by your System Administrator or Reusable Asset Service Administrator.

Access

Ribbon	Publish > Model Exchange > Reusable Assets
--------	--

Connect to Assets

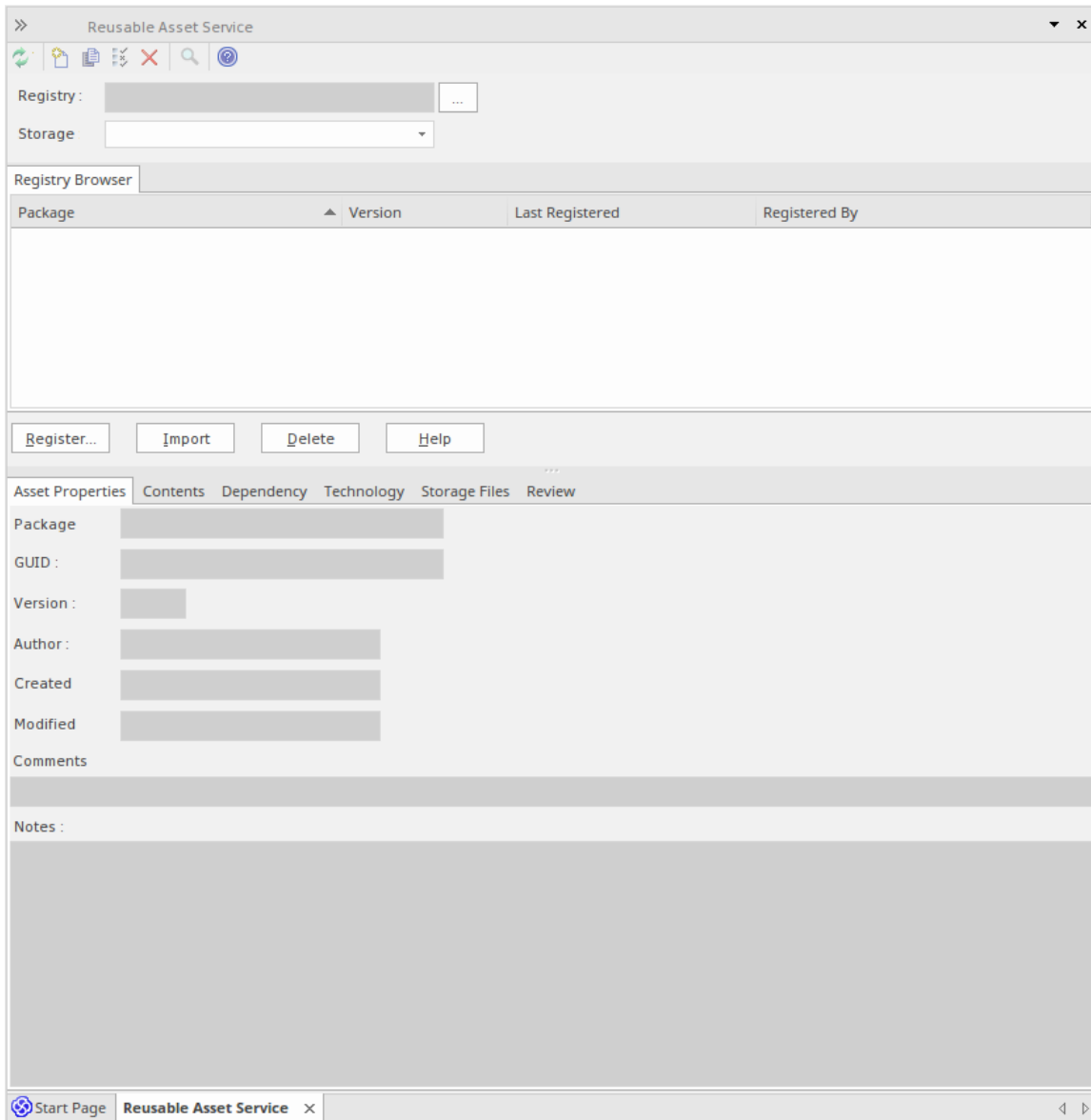

Option	Detail
Registry	<p>This field normally defaults to the last-used registry name. If the field is empty, or if you want to switch to a different registry, click on the  button to the right of the field.</p> <p>The 'Cloud Connection' dialog displays. Using the information provided by your administrator, type in the Protocol, the</p>

server name, the Port and the name of the model hosting the registry data.

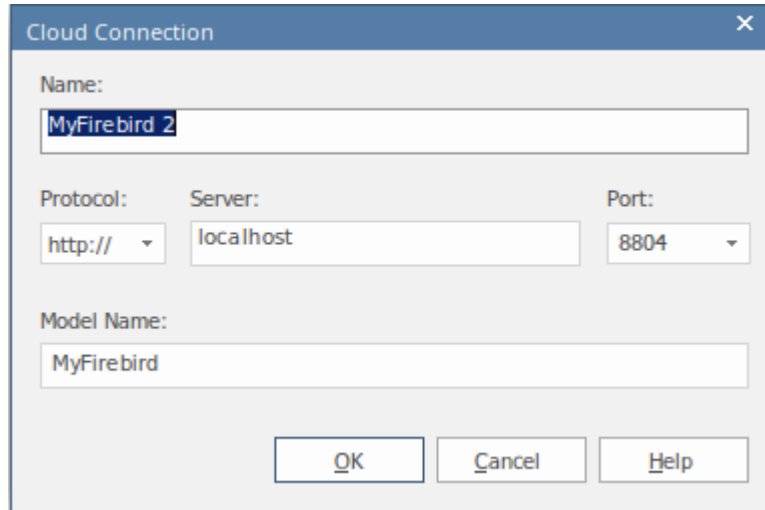

For example, if you wanted to download the UBL Frameworks into your model, you would specify the server 'sparxcloud.com' and the model name 'modelpatterns'.

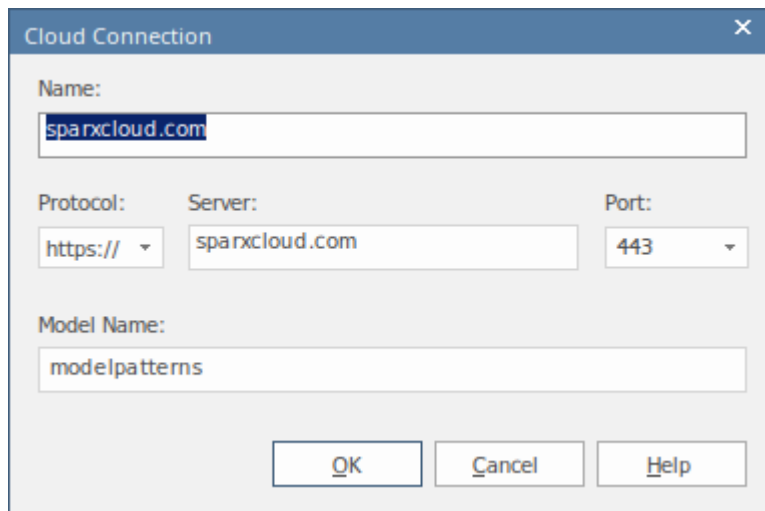

If advised by your Administrator, type in the user name and password for the server.

Click on the OK button; the 'Registry' field now shows the server name.

	<p>Note:</p> <ul style="list-style-type: none">• If no Registry is available, Administrator can create a Cloud-based Repository to act as the Reusable Asset Registry
Storage	<p>If there is more than one Storage available in the Registry, this field defaults to the first listed in the Registry. To check for or select other Storages, click on the drop-down arrow at the right of the field. Click on the Storage to review. For example, if you were downloading UBL frameworks, you would select 'UBL' in the list.</p> <p>The 'Registry Browser' tab displays the Packages registered in the selected Storage.</p>

Notes

- The Reusable Asset Service is available in the Corporate, Unified and Ultimate Editions of Enterprise Architect

Browse Assets

When you select a Storage in the Reusable Asset Service, the 'Registry Browser' tab immediately displays a list of the Packages registered in that Storage. You can review and use these Packages using the context menu and buttons on the tab.

You can review the properties and contents of the selected Package in the Storage, and access any files in the Storage, using the tabs in the lower half of the Reusable Asset Service view, underneath the 'Registry Browser' tab.

If you have left the Registry Browser open for a while and there is a possibility that the Registry has been changed, you can click on the  icon in the Reusable Asset Service toolbar to refresh the Browser with the latest contents of the Registry.

Access

Ribbon	Publish > Model Exchange > Reusable Assets > Registry Browser
--------	---

Review Assets

Option	Detail
--------	--------

Toggle Filter Bar	Right-click on the column headings and select this option to show or hide the Filter Bar on the display.
(filter bar fields)	Type in the appropriate characters to list only Packages that have that string of characters in the values in the corresponding column.
Package	This column shows the name of the Packages held in the selected Storage.
Version	<p>This column defaults to the most recent version of each Package held in the selected Storage.</p> <p>You can click on the drop-down arrow at the end of a field and select a different version of the corresponding Package, if any have been registered.</p>
Last Registered	This column shows the date and time at which the currently-listed version of each Package was registered.
Registered By	This column shows the user name of the person who registered the currently-listed version of each Package.

Import	<p>Click on a Package name and click on this button to begin to import either the Package alone or the Package and its dependent structures into your model. You can perform the same action by right-clicking on the Package name and selecting the 'Import from Registry' menu option.</p> <p>If the Package from the Registry already exists in your model, it is deleted and replaced by this import.</p> <p>For a:</p> <ul style="list-style-type: none">• 'Learning Center Library' Storage, the 'Download Library' dialog displays• 'Reference Data Library' Storage, the 'Import Reference Data' dialog displays• 'Source Code Library' Storage, the 'Save As' dialog displays
Compare with Package in Model	<p>If you have previously imported a Package from the Registry into your model, you can right-click on the Package name in the 'Registry Browser' tab and select this option to compare the imported Package with the Registry version, and show any differences.</p> <p>The system automatically selects the model Package from the Browser</p>

	window.
Find in Project Browser	If you have previously imported a Package from the Registry into your model, you can right-click on the Package name in the Registry Browser and select this option to highlight the corresponding Package in the Browser window.

Notes

- Some of the other options available on the Registry Browser are used to set up assets in the Registry
- If the Storage is password-protected, a prompt for you to enter a password displays when you select to perform an operation on the data; in this situation, you need the 'Read-only' password to process the information from the Storage, and the 'All-access' password to change the information in the Storage
- The 'Registry Browser' tab will be empty for a 'Learning Center Library', 'Reference Data Library' or 'Source Code Library' type Storage - the contents of these types of Storage will be available in the 'Storage Files' tab of the Reusable Asset Service view

Asset Properties

When you select a Storage and a Package in the 'Registry Browser' tab, the first four tabs in the lower half of the Reusable Asset Service view are updated with information from the Package. The 'Asset Properties' tab is a read-only view of the properties of the selected Package itself.

Access

Open the Reusable Asset Service window using one of the methods outlined here.

Select a Package, then click on the 'Asset Properties' tab to display properties for that Package.

Ribbon	Publish > Model Exchange > Reusable Assets
--------	--

Review Package Properties

Field	Detail
Package	Displays the name of the selected Package.
GUID	Displays the Global Unique Identifier of

	the Package.
Version	Displays the version reference (such as 1.1 or Beta) of the Package.
Author	Displays the user ID of the person who created the Package (the Package Author).
Created	Displays the date and time at which the selected version of the Package was created (that is, registered) in the Registry.
Modified	Displays the date and time at which the selected version of the Package was last modified (that is, re-registered) in the Registry.
Comments	Displays any comment recorded against the Package when it was registered in the Storage.
Notes	Displays the notes recorded against the Package when it was registered in the Storage.

Notes

- The 'Asset Properties' tab will be empty for a 'Learning Center Library', 'Reference Data Library' and 'Source Code Library' type Storage

Package Contents

When you select a Storage and a Package in the 'Registry Browser', the first four tabs in the lower half of the Reusable Asset Service view are updated with information from the Package. The 'Contents' tab lists the diagrams and elements (including child Packages) held in the selected Package, listing the two types of object separately. You can organize the information within a column into alphabetical or reverse-alphabetical order for ease of reference, and use the Filter bar to filter the display to show only items with values containing specific characters or digits.

Access

Open the Reusable Asset Service window using one of the methods outlined here.

Select a Package, then click on the 'Contents' tab, to display the contents of that Package.

Ribbon	Publish > Model Exchange > Reusable Assets
--------	--

Review Package Contents

Option	Detail

Content Type	Click on this button to toggle between listing the Package diagrams first and listing the Package elements first.
Toggle Filter Bar	Right-click on the column headings and select this option to show or hide the Filter Bar on the display.
<filter bar fields>	Type in the appropriate characters to list only elements and diagrams that have that string of characters in the values in the corresponding column.
Content Type: Diagram Content Type: Element	These are the headers for the two types of object listed in this tab. Click on the appropriate expansion box to hide or show the list of diagrams or elements under the heading.
Name	Displays the name of the element or diagram available in the Package.
Type	Displays the type of the element or diagram, such as UseCase or Use Case diagram.
GUID	Displays the Global Unique Identifier of the element or diagram.

Content Type	Displays the object type of the item - Element or Diagram.
Find in Project Browser	Right-click on an element or diagram line and select this option to see if the element or diagram also exists in your model and, if it does, to highlight it in the Browser window.
View Diagram	Right-click on a diagram name and select this option to display the diagram within a labeled frame, as an image in a separate window. The image is displayed at the default zoom level for the model. Alternatively, to view the diagram, double-click on the diagram name.

Notes

- The 'Contents' tab will be empty for a 'Learning Center Library', 'Reference Data Library' or 'Source Code Library' type Storage

Package Dependencies

A Package held as an asset in the Reusable Asset Service registry might contain elements and diagrams that have relationships with objects in other Packages. The Packages containing these 'external' objects will also have been added to the Registry to support the first Package, and will be listed in the 'Registry Browser' tab along with other (unrelated) Packages. You can establish whether the selected Package in the 'Registry Browser' tab has links to other Packages in the Registry, and which they are, by reviewing the 'Dependency' tab.

Package A depends on Package B if any of these constructs (or their Tagged Values) in Package A references elements in Package B:

- Elements
- Attributes
- Operations
- Operation Parameters
- Diagrams
- Connectors

Access

Open the Reusable Asset Service window using one of the methods outlined here.

Select a Package, then click on the 'Dependency' tab, to display a list of Dependencies for that Package.

Ribbon	Publish > Model Exchange > Reusable Assets
--------	--

Check Package Dependencies

Option	Detail
Package	Displays the name of the related Package.
Version	Displays the latest registered version of the related Package that has links to the selected Package.
GUID	Displays the Global Unique Identifier of the related Package.
Find in Project Browser	Right-click on the 'Package' line and select this option to see if the Package also exists in your model and, if it does, to highlight it in the Browser window.

Notes

- If one Package depends on another, and that second

Package itself depends on another Package, both the second and third Packages are shown in the 'Dependency' tab

- The 'Dependency' tab will be empty for a 'Learning Center Library', 'Reference Data Library' or 'Source Code Library' type Storage

Package Technologies

It is possible that the asset Package in the Registry is associated with one or more Technologies, especially if the Package comes from a model developed as an extension or customization of the UML. You can check whether an asset Package has any associated Technologies, and what they are, by viewing the 'Technology' tab of the Reusable Asset Service view.

Access

Open the Reusable Asset Service window using one of the methods outlined here.

Select a Package, then click on the 'Technology' tab, to display a list of Technologies required to support that Package.

Ribbon	Publish > Model Exchange > Reusable Assets
--------	--

Review Technologies

Option	Detail
Name	Displays the name of the Technology as

	recorded in the Registry.
Version	Displays the required version of the Technology to support the asset Package, available through the Registry.
ID	Displays the unique identifier of the Technology.
Type	<p>Identifies whether the Technology is system-supplied and built in to Enterprise Architect (such as BPMN 2.0 or ArcGIS), or user-defined.</p> <p>A user-defined technology can be introduced from an external source or developed by a user within the system.</p>
Registry Status	<p>Indicates whether the Technology file is:</p> <ul style="list-style-type: none"> • Available - the Technology file is registered in the current Storage, or • Unavailable: <ul style="list-style-type: none"> - The Technology file is not registered in the Storage, or - The Technology is a built-in Technology and is already integrated with your system, or must be purchased under license, or - The Technology is available from a URL and can be downloaded

	from that URL
Import Technology	<p>If your local system does not have one of the Available Technologies, you can quickly import it from the Registry.</p> <ol style="list-style-type: none">1. Right-click on the Technology name and select the 'Import Technology' option.2. A prompt displays for you to confirm the import to your system; click on the Yes button.3. A message displays to confirm that the Technology has been imported; click on the OK button. <p>You might have to restart Enterprise Architect to activate the Technology.</p> <p>Other than the remote Technologies, you cannot import a Technology flagged as 'Unavailable'. You can import a remote Technology from its URL site.</p>

Notes

- You can also import Available Technologies from the registry as part of the process of importing the asset Package
- If the Storage is password protected, a prompt to enter

your password displays (this can be a Read-Only or a Complete Access password) after you confirm that you want to import the Technology; you cannot import the Technology without this password

- The 'Technology' tab will be empty for a 'Learning Center Library', 'Reference Data Library' or 'Source Code Library' type Storage

Storage Files

The 'Storage Files' tab of the Reusable Asset Service view simply lists the files that have been uploaded to the specified Storage. The files can be of any type, uploaded from any directory on any system connected to the registry. Typically they would be document or graphics files that provide standards, guidelines or design information on a model structure. The tab displays the file name and extension, and a comment on the nature or purpose of the file.

Files held in the Registry are compressed, so to view the contents you download them onto your local system.

Access

Open the Reusable Asset Service window using one of the methods outlined here.

Select a Package, then click on the 'Storage Files' tab to display a list of files associated with the Package, that are available for download.

Ribbon	Publish > Model Exchange > Reusable Assets
--------	--

Review files in Model Package type Storage

On the 'Storage Files' tab, check the 'Comments' field

against each file that interests you.

To view the contents of a file, right-click on the file name and select the 'Import From Registry' option. The 'Save As' browser displays, through which you select the directory into which to copy the file.

Click on the Open button. The file is copied into the selected location, from which you can open it.

Notes

- If the Storage is password-protected, the system prompts you to enter a password before you begin importing a file from the Storage; in this case you require either a 'Read-Only' or a 'Complete Access' password

Add Review Comments

For any Model Package in the Storage, you can add individual review comments on any aspect of the Package. These comments provide a permanent record on the Package - once they have been saved they cannot be edited or deleted. Each comment is attributed to the ID of the user who entered it, and is date stamped.

Note that the Review tab is present for a Learning Center Library Storage, Reference Data Library Storage, and Source Code Library Storage; however, the tab and panel are disabled and review comments cannot be entered for these storage types

Access

Open the Reusable Asset Service window using one of the methods outlined here.

Select a Registry, Model Storage and Package, then click on the 'Review' tab to display a list of comments associated with the Package, and a panel for entering further comments.

Ribbon	Publish > Model Exchange > Reusable Assets
--------	--

Actions

Action	Description
Review Existing Comments	<p>If there appears to be a longer comment than can be shown in the 'Review' tab, click on it. The full text displays in the 'Comments' field in the lower panel.</p>
Add a New Comment	<p>Click on the New button and start typing your comment on the Package in the 'Comments' field. You can delete and edit text as you type.</p> <p>When you have finished writing your comment, click on the Save button. Your comment, preceded by your user ID and the current date, is displayed in the 'Review' panel.</p> <p>Once you have saved your comment, you cannot edit or delete it.</p>

Compare an Asset to the Model

If you are developing a Package in your model against a standard structure, or using common elements from the Reusable Asset Service, you can check that your model conforms to the standard or incorporates any changes to the common elements, by performing a comparison between the Asset Package and your model.

Access

Open the Reusable Asset Service view using one of the methods outlined here.

Select a Package, then right-click on the Package and choose 'Compare with Package in Model'.

Ribbon	Publish > Model Exchange > Reusable Assets
--------	--

Compare Asset Package and Model

A prompt displays for you to confirm the comparison. Click on the Yes button.

The Baseline Comparison view displays, showing the element hierarchy in which differences have been detected between the Package in the model and the asset Package in the Registry (as the Baseline).

All facilities of the standard Baseline Comparison are available, including the ability to 'roll back' differences so that the element or Package in the model matches the Registry.

Notes

- If the Storage is password-protected, the system prompts you to enter a password before you begin comparing information in the Storage and in the model; in this case you require either a Read-Only or a Complete Access password

Register Assets

After you have set up your Storages in the Reusable Asset Service Registry, you can register assets in them. The assets include:

- Packages of modeling structures of your model, shown in the Browser window; these Packages can include diagrams and subordinate Packages
- Any Packages containing model components on which the primary Asset Packages depend
- Any MDG Technologies that you used in developing the Asset Packages, and that you decide to register with the Packages
- Any text or graphics files you want to make available to your corporate community; these files are compressed before being added to the Storage

You register the first three items together. You can register files in the Storage during that same process, or separately.

You can register separate versions of the same Package. If you register a Package that already exists in the Registry under the same version reference, and the Storage has 'Draft' status, the existing version is overwritten. If you register the same Package with a different version number or reference, it is registered separately and users can access both versions of the Package from the Registry.

'Learning Center Library', 'Reference Data Library' and 'Source Code Library' type Storages cannot contain Packages of modeling structures - they can contain only

Library files, which will appear in the 'Storage Files' tab. A Library file is:

- A zipped file containing Enterprise Architect-specific Learning Center files for the 'Learning Center Library' Storage type
- An XML file containing Enterprise Architect-specific reference data XML files for the 'Reference Data Library' Storage type
- A zipped file containing source code files for the 'Source Code Library' Storage type

Once registered, the Library file will be available in the 'Storage Files' tab of the Reusable Asset Service view.

Access

Ribbon	Publish > Model Exchange > Reusable Assets
--------	--

Storage Types

Option	Description
Register Packages and Files as	Registering Package-trees including diagrams, as well as files.

Assets	
Register Learning Center Library	Register Learning Center files for use in other repositories.
Register Reference Data Library	Register the current model's Reference Data Library for use in other repositories.
Register Source Code Library	Register Zipped files of source code libraries for distribution.

Register Packages and Files as Assets

Having set up your Storages in the Reusable Asset Service Registry, you can register Packages of modeling structures as selected in the Browser window in your current model. These Packages can include diagrams and subordinate Packages, as well as files.

You can also create an Asset that purely contains files, by not selecting a Package, but just selecting a file. See the section *Register File as Asset* in this topic.

Register Packages and Files as Assets

Step	Action
1	In the Reusable Asset Service view, select the appropriate Registry and Storage.
2	In the Browser window, click on the Package to register as an Asset.
3	On the 'Registry Browser' tab, click on the Register button. If the Storage is password protected, a prompt displays for your 'Complete Access' password. Type this in and click on the OK button.

4	<p>The 'Register Package(s)' dialog displays, showing the:</p> <ul style="list-style-type: none">• Name and type of the Storage• Name and status of the selected Package (the status at this point being 'Pending')• The name, GUID and current version of the selected Package; you can type a different version number or text string if necessary <p>If there is a version of the Package already in the Registry, and the Storage has 'Draft' status, you can either:</p> <ul style="list-style-type: none">• Overwrite the registered Package with an update of that version, or• Add the updated Package as another Asset under a different version number; in this case, the 'Packages to Register' panel shows the version number, registration date and comments on the latest version of the Asset Package <p>You cannot overwrite an existing Package if the Storage has 'Complete' status. In this case, add the Package under a different version number.</p>
5	<p>In the 'Comments' field type a short comment and, in the 'Notes' field, a longer explanation of the Package being registered.</p>
6	<p>Click on the Check Dependency button and resolve the dependencies of the Package.</p>

	<p>At the end of this process, the selected Package has the status 'Ready' (for registration).</p>
7	<p>You can, at this point, also register files as assets of the Storage. See Step 4 of the next table, <i>Register File as Asset</i>.</p> <p>However, if you prefer you can follow the complete procedure separate from registering Packages.</p>
8	<p>Click on the Register button.</p> <p>A prompt displays to confirm registering the Package. Click on the Yes button.</p> <p>If the same version of the selected Package already exists in the Registry (if the Storage is a 'Draft') a prompt displays to confirm overwriting it. Click on the Yes button.</p> <p>A progress dialog displays. If the Package does not have any associated MDG Technologies, a message displays confirming that Package registration is complete. Go to step 10.</p>
9	<p>If the Package has one or more associated MDG Technologies, the 'Register MDG Technology' dialog displays, listing the Technologies and prompting you to register (OK) or ignore all of them.</p> <p>If you want to register some Technologies but not others, click on those you do not want to register, and click on the Remove button for each one in turn.</p>

	<p>Click on the OK button or Ignore button.</p> <p>A message displays confirming that Package and Technology registration is complete.</p> <p>Notes:</p> <ul style="list-style-type: none">• If a remote Technology is removed from registration (that is, the Technology is not registered along with the Package), the registered Package will refer to this Technology at its URL. When importing the Package from Registry, the system will import this remote Technology from its URL (if the remote Technology is not already available in the importing model)• If a remote Technology is registered with the Package being registered, the system will store a copy of the Technology file in the Registry. When importing the Package from Registry, the system will import the Technology stored in the Registry and will not import it from its URL (if the remote Technology is not already available in the importing model)
10	<p>Click on the OK button.</p> <p>The 'Registry Browser' tab is updated with the newly-added details of the Package and any dependent Packages. You can review the details on the tabs on the lower half of the Reusable Asset Service view.</p>

Register File as Asset

Step	Action
1	In the Reusable Asset Service view, select the appropriate Registry and Storage.
2	<p>On the 'Registry Browser' tab, click on the Register button.</p> <p>If the Storage is password-protected, a prompt displays for your 'Complete Access' password. Type this in and click on the OK button.</p> <p>The 'Register Package(s)' dialog displays.</p>
3	If any Packages are listed in the 'Packages to Register' panel, and you do not want to re-register them, clear the checkbox against each Package name.
4	<p>Click on the Additional Files button.</p> <p>The 'Select Additional Files' dialog displays.</p>
5	<p>Click on the Add button.</p> <p>A 'Select' screen displays, on which you browse for and click on the required file. You can only select one file at a time on this browser.</p>

6	<p>Click on the Open button. The 'Add Comment' dialog displays.</p>
7	<p>Type a brief comment on the nature or purpose of the file in the Registry, and click on the OK button. Focus returns to the 'Select Additional Files' dialog, which now lists the selected file.</p>
8	<p>Repeat steps 5-7 for each Asset file to register. When you have finished, click on the OK button. The 'Register Package(s)' dialog redisplay.</p>
9	<p>Click on the Register button. A prompt displays to confirm registration of the files.</p>
10	<p>Click on the Yes button. A 'Progress' dialog displays while the files are registered, followed by a message confirming that the (Package and) File registration is complete.</p>
11	<p>Click on the OK button to clear the message, and to return focus to the Reusable Asset Service view. You can review the files on the 'Storage Files' tab in the lower half of the view.</p>

Register Learning Center Library

Here is a walk through for registering a Learning Center Library file. This Storage can be populated only with Library files, not with Asset Packages.

Register Learning Center Library

Step	Action
1	In the Reusable Asset Service view, select the appropriate Registry and 'Learning Center Library' Storage.
2	<p>On the 'Registry Browser' tab, click on the Register button.</p> <p>If the Storage is password protected, a prompt displays for your 'Complete Access' password. Type this in and click on the OK button.</p>
3	<p>The 'Register Learning Center Library' dialog displays.</p> <p>Click on the  button next to the 'File' field and select the Library file.</p> <p>Type in a short comment on the Library being registered, in the 'Comments' field.</p>

4	<p>Click on the Register button.</p> <p>A prompt displays to confirm registering the Library file. Click on the Yes button.</p> <p>If the same Library file already exists in the Registry, a prompt displays to confirm overwriting it. Click on the Yes button.</p> <p>A progress dialog displays followed by a message confirming that Library registration is complete.</p>
5	<p>Click on the OK button.</p> <p>The 'Storage Files' tab in the lower half of the Reusable Asset Server view is updated with the newly-added Library file.</p>

Register Reference Data Library

When you have a complete project set up, with fully defined reference data, it is possible to transfer the reference data via the RAS by setting an Asset that you can import into another repository. The exported data includes all instances of the selected data type in the project; for example, all defined cardinality values, or all Document Style Templates.

Process

Step	Action
1	In the Reusable Asset Service view, select the appropriate Registry and 'Reference Data Library' Storage.
2	On the 'Registry Browser' tab, click on the Register button. If the Storage is password protected, a prompt displays for your 'Complete Access' password. Type this in and click on the OK button.
3	The 'Register Reference Data Library' dialog displays. Press the  button next to the 'File' field and select : <ul style="list-style-type: none">• From File System – to select an existing Reference

	<p>Data XML file from the file system</p> <ul style="list-style-type: none">• From Model – to open the 'Export Reference Data' dialog for selecting categories that will be registered as the Reference Data Library once the Register button is clicked and a name is entered in the 'Enter Reference Data File Name 'dialog <p>Type in a short comment for the Library being registered in the 'Comments' field.</p>
4	<p>Click on the Register button.</p> <p>A prompt displays to confirm registering the Library file. Click on the Yes button.</p> <p>If the same Library file already exists in the Registry, a prompt displays to confirm overwriting it. Click on the Yes button.</p> <p>A progress dialog displays followed by a message confirming that Library registration is complete.</p>
5	<p>Click on the OK button.</p> <p>The 'Storage Files' tab in the lower half of the Reusable Asset Server view is updated with the newly-added Library file.</p>

Register Source Code Library

These steps outline the process for registering a source code library.

Process

Step	Action
1	In the Reusable Asset Service view, select the appropriate Registry and 'Source Code Library' Storage.
2	On the 'Registry Browser' tab, click on the Register button. If the Storage is password protected, a prompt displays for your 'Complete Access' password. Type this in and click on the OK button.
3	The 'Register Source Code Library' dialog displays. Select the Library file by pressing the  button next to the 'File' field. Type in a short comment for the Library being registered, in the 'Comments' field.
4	Click on the Register button. A prompt displays to confirm registering the Library

	<p>file. Click on the Yes button.</p> <p>If the same Library file already exists in the Registry a prompt displays to confirm overwriting it. Click on the Yes button.</p> <p>A progress dialog displays, followed by a message confirming that Library registration is complete.</p>
5	<p>Click on the OK button.</p> <p>The 'Storage Files' tab in the lower half of the Reusable Asset Server view is updated with the newly-added Library file.</p>

Check Package Dependencies

As you register a Package in the Reusable Asset Service, the system provides a check on whether that Package is dependent on any external content; that is, whether it links to any modeling component held in Packages other than its own child Packages. You can perform three types of dependency check:

- Complete, which will consider Package A to be dependent on Package B if Package A contains any element, attribute, operation, operation parameter, diagram or connector (or their Tagged Values) that references elements in Package B
- Normative, which is the same as a Complete Dependency Check except that it will not treat as a dependency for Package A any element from Package B that is added as a link on a diagram in Package A
- Package Dependency/Import, where only those Packages that are the target of a Dependency/Package Import connector from Package A will be treated as dependent Packages for Package A

You perform this dependency check as an integral part of the Asset Registration process (specifically, at step 6 of the *Register Package as Asset* process). The check automatically identifies, firstly, the Packages directly needed by the Asset Package, and then any Packages needed by those initial Packages, and so on until the needed Packages are not dependent on any other.

In practice, such dependency chains are likely to be quite short. If you know that the original Asset Package is dependent on two other Packages, one of which is subordinate to the other, you can simplify the process further by selecting the Parent or Ancestor Package first and thus avoid the extra steps of selecting the two Packages separately.

Access

Open the Reusable Asset Service window, using one of the methods outlined here.

Ribbon	Publish > Model Exchange > Reusable Assets : Register
--------	---

Check Package Dependencies

Step	Action
1	Select the appropriate Registry, Storage and version of the model Package to register, and provide any appropriate comments or notes.
2	Click on the Check Dependency button. If there are no Packages on which the Asset Package

depends, the system sets that Package to 'Ready'. Go to step 6.

The 'Select Needed Package: <dependent package name>' dialog displays, showing the model hierarchy containing the Packages needed by the Asset Package. Each needed Package has a selected checkbox against it.

If you know that a needed Package is a child or grandchild of another needed Package, click on the checkbox next to the 'higher' Package name so that the child is validated as part of the parent. In this example, if the Asset Package has dependencies on both External factors and Location, click on the 'External factors' checkbox to register both dependencies as External factors.

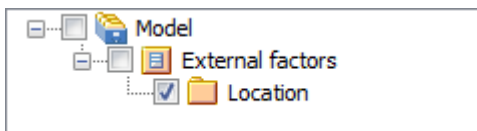

If the needed Package is already registered in the Registry, it is indicated by a globe icon:

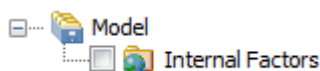

In this case, select the 'Use latest version of selected package in Registry (if available)' checkbox to link to the registered version. For such Packages, no further dependency check is performed and, on the 'Register Package(s)' dialog, the Package's Status is set to 'Ready'.

3 Click on the OK button.

	<p>The 'Register Package(s)' dialog updates to show the initial 'Asset Package status' as 'Ready', and to list the needed Packages each with the status of 'Pending'.</p>
4	<p>Click on the Check Dependency button again.</p> <p>If there are no Packages on which the needed Package depends, the system sets that Package to 'Ready' and sets the focus on the next Pending Package. If there are no more Pending Packages, go to step 6.</p> <p>If the needed Package is dependent on other Packages, the 'Select Needed Package: <dependent package name>' dialog displays again, showing the model hierarchy containing those Packages, each with a selected checkbox next to it. As in step 2, you can select a 'higher' Package if appropriate.</p>
5	<p>Click on the OK button.</p> <p>The 'Register Package(s)' dialog updates to show the first needed Package status as 'Ready', and to list any further needed Packages with the status of 'Pending'.</p>
6	<p>If there are further needed Packages in the chain, repeat step 4. The system automatically identifies them and lists them for validation as in step 5.</p> <p>Otherwise the system sets the final needed Package status to 'Ready' and you can continue to register files and MDG Technologies.</p>

Notes

- A Package with status 'Pending' cannot be registered; only Packages with status 'Ready' can be registered
- If you are certain that there are no parent-child relationships between the needed Packages, you can work through these steps quickly by just clicking on the Check Dependency button and OK button alternately until all Packages in the Package to Register list have the status Ready
- The system does not allow you to register an Asset Package that has dependencies on its own parent or grandparent Package; such dependencies would cause the Asset Package to be registered twice - by itself and as part of the parent Package - creating the risk of differences developing between the two instances

Update an Asset

Over time, you might need to revise the contents of the Registry. Such updates can include:

- Registering additional Asset Packages and files
- Registering a new version of an Asset Package
- Registering a new edition of a Storage file
- Registering new Libraries
- Deleting an Asset Package
- Deleting a Storage file
- Deleting a Library
- Changing the details of a Storage
- Deleting an entire Storage and the assets and files within it

Access

Ribbon	Publish > Model Exchange > Reusable Assets > Registry Browser
--------	---

Update Tasks

Task	Detail
------	--------

<p>Register new Asset Packages and Storage files</p>	<p>You can add further Asset Packages and files to a Storage at any time.</p>
<p>Register a new version of an Asset Package</p>	<p>You register a new version of an Asset Package as if it were a new Asset. In the 'Current Version' field on the 'Register Package(s)' dialog, you type a different number or reference to that assigned to the currently-registered Asset.</p> <p>You can overwrite an existing Asset Package under the same version number only if the Storage has 'Draft' status. If the Storage has 'Complete' status, you cannot overwrite the existing Asset Package under the same version number. To replace the current version, you must delete the Asset from the Storage and register the Package again.</p>
<p>Delete Asset Package from Storage</p>	<p>Click on the Package name in the 'Registry Browser' tab and either:</p> <ul style="list-style-type: none"> • Click on the Delete button or • Right-click and select the 'Delete From Registry' menu option <p>In either case a short submenu displays, prompting you to select to delete:</p>

	<ul style="list-style-type: none"> • The Asset Package only, or • The Asset Package and the Packages on which it is directly or indirectly dependant <p>When you select the appropriate option, a prompt displays for you to confirm the deletion.</p> <p>Click on the Yes button. A message displays to confirm that the Package has been deleted from the Registry, and the name of the Package is removed from the 'Registry Browser' tab.</p> <p>If the Storage is password-protected, the system prompts you to enter a 'Complete Access' password before it begins deleting the Package(s).</p> <p>If any of the registered Packages depend on the Package being deleted, the system displays the names of these Packages and prompts for confirmation before deleting each Package.</p>
<p>Register a new version of a Storage File</p>	<p>You register a new version of a Storage file as if it were a new file under a different file name.</p> <p>You can overwrite an existing file under the same file name only if the Storage has 'Draft' status. If the Storage has 'Complete' status, you cannot overwrite</p>

	<p>the existing file. To replace the current version, you must delete the file from the Storage and register the file again.</p>
<p>Delete Storage Files from Storage</p>	<p>On the 'Storage Files' tab, right-click on the file name and select the 'Delete From Registry' option. A prompt displays for you to confirm the deletion.</p> <p>Click on the Yes button. A status message confirms the deletion, the file is removed from the Registry and the file name is removed from the 'Storage Files' tab.</p> <p>If the Storage is password-protected, the system prompts you to enter a 'Complete Access' password before it begins deleting the file.</p>
<p>Register a new Library File</p>	<p>You can add further Library files to a Storage at any time.</p> <p>When you register a Library file, the file name and location will be used as the unique identifier for the file. You can overwrite this Library file in the Registry by registering a file with the same name and from the same file system location.</p>
<p>Delete Library Files</p>	<p>To delete all Library files in Storage, click on the Delete button in the 'Registry</p>

<p>from Storage</p>	<p>Browser' tab.</p> <p>To delete a particular Library file, right-click on the Library file name in the 'Storage Files' tab and select the 'Delete From Registry' option.</p> <p>A prompt displays for you to confirm the deletion. Click on the Yes button. A status message confirms the deletion, each Library file is removed from the Registry and each Library file name is removed from the 'Storage Files' tab.</p> <p>If the Storage is password-protected, the system prompts you to enter a 'Complete Access' password before it begins deleting the Library file(s).</p>
<p>Change Storage Details</p>	<p>This task is as documented for setting up the Registry. Note that whilst you can copy a Storage as a new Storage, you cannot transfer assets directly between existing Storages.</p>
<p>Delete a Storage and its contents</p>	<p>This task is as documented for setting up the Registry. Note that whilst you can copy a Storage as a new Storage, you cannot transfer assets directly between existing Storages.</p>
<p>Refresh</p>	<p>If there is a possibility that another user</p>

Registry Browser	has updated the Registry while you have had it open, click on the  icon in the Reusable Asset Service toolbar to refresh your display from the latest updates to the Registry.
-----------------------------	---

Import an Asset into the Model

The Reusable Asset Service provides common or standard information and data that you can import into your local model. The unit that you import is a selected version of the Asset Package; you can also, optionally, import:

- Other Packages on which the selected Asset Package depends, and/or
- Available Technologies that support full use of the model structures in the Asset Package

The Asset Package (with, if selected, any needed Packages) is imported into the currently-selected model Package in the Browser window, unless the Asset Package already exists anywhere else in the Project. In this case, the system locates the existing Package and overwrites it with the imported Asset Package.

Access

Open the Reusable Asset Service window, using one of the methods outlined here.

On the 'Registry Browser' tab, either;

- Select an Asset Package and click on the Import button, or
- Right-click on an Asset Package and select the 'Import from Registry' option

Ribbon	Publish > Model Exchange > Reusable Assets
--------	--

Import Asset Package

Before selecting an Asset Package to import into your model, click on the 'Version' drop-down arrow and select the appropriate version of the Package to import.

When you select to import an Asset Package into your model, a short menu displays from which you select to import:

- The Package alone or
- The Package with the related Packages on which it is dependent

A prompt then displays for you to confirm the import, and to warn you that if the Package already exists in the model, it will be overwritten by the import. Click on the Yes button to continue, or the No button to cancel the import.

If the Storage is password protected, after you confirm the import a prompt displays for your 'Read-Only' or 'Complete-Access' password; enter this and click on the OK button.

The 'Import from Registry' dialog displays, followed by confirmation that the import of the Package or Packages is complete. Click on the OK button.

If the Package depends on Technologies

If the Technologies associated with an Asset Package are

not already on your system and/or enabled in your model, during the display of the 'Import from Registry' dialog the 'Import Technology From Registry' dialog also displays. Process this dialog as described.

Option	Detail
Name	<p>Displays the name of the Technology as recorded in the Registry.</p> <p>The checkbox against each name is selected by default. If you want to import one technology but not another, deselect the checkbox of the technology to ignore.</p>
Version	<p>Displays the required version of the Technology to support the Asset Package, available through the Registry.</p>
Registry Status	<p>Indicates whether the Technology file is:</p> <ul style="list-style-type: none"> • Available - the Technology file is registered in the current Storage, or • Unavailable - for one of these reasons: <ul style="list-style-type: none"> - The Technology file is not registered in the Storage, or - The Technology is a built-in Technology and is already integrated with your system, or must be purchased under license, or - The Technology is available from a URL and can be downloaded from

	that URL
Model Status	Indicates whether the Technology is already in your model and disabled. (If the Technology is in your model and enabled, there is no need to import it and it is not listed in the dialog.)
OK	Click on this button to import and/or enable the selected Technology or Technologies in your system. A status message displays to indicate that the Package and Technologies have been imported and the Technologies enabled. You might have to restart Enterprise Architect for the Technologies to take full effect. Click on the OK button to clear the message. In the Browser window, the Package has been added to the model with (if selected) the Packages on which it is dependent.

Notes

- You can also import Technologies separately from the Package that is dependent on them, using the 'Technology'

tab of the Reusable Asset Service view

- 'Learning Center Library', 'Reference Data Library' and 'Source Code Library' type Storages do not contain any Asset Packages

Search Registry

After you have set up your Storages in the Reusable Asset Service Registry and registered Asset Packages in them, you can search the Registry to locate modeling items such as Packages, elements and diagrams using their names or Global Unique Identifiers (GUIDs).

Access

Ribbon	Publish > Model Exchange > Reusable Assets
--------	--

Search Registry for Asset Package Contents

Step	Action
1	Click on the  icon in the Reusable Asset Service toolbar. The 'Search Registry' dialog displays.

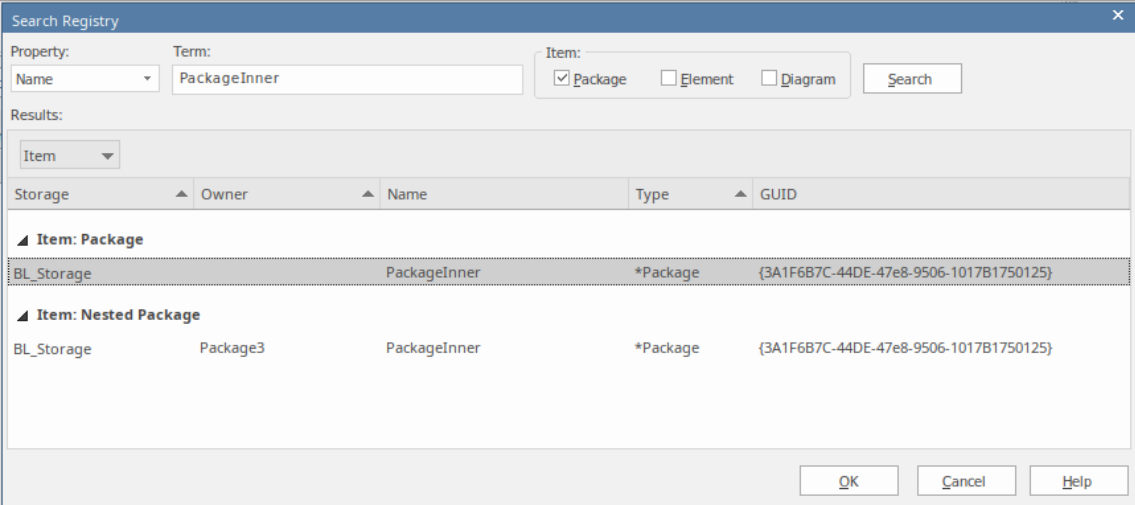
	
<p>2</p>	<p>In the 'Property' field, select:</p> <ul style="list-style-type: none"> • 'GUID' if you intend to search the Registry for a modeling item based on its Global Unique Identifier • 'Name' if you intend to search the Registry for a modeling item based on its name
<p>3</p>	<p>In the 'Term' field, type in the GUID or name of the modeling item. Note the interpretation of this field is case-sensitive.</p>
<p>4</p>	<p>In the 'Item' section, select the modeling item to search for; that is, Package, element and/or diagram.</p>
<p>5</p>	<p>Click on the Search button to search the Registry for the selected modeling item(s) and to display the results, if any, in the 'Results' section.</p>
<p>6</p>	<p>The 'Results' section displays the results of the</p>

	<p>search, showing these details:</p> <ul style="list-style-type: none">• Storage - the name of the Storage in the Registry that has the modeling item• Owner - the name of the Asset Package that contains the modeling item• Name - the name of the modeling item• Type - the Enterprise Architect type of the modeling item• GUID - the Global Unique Identifier of the modeling item <p>Notes :</p> <ul style="list-style-type: none">• The search results will be grouped by modeling item• The group <i>Nested Package</i> represents all those Packages (that satisfy the search criteria and) that are a part of another registered Package
7	<p>Select an entry in the 'Results' section and click on the OK button to open the Storage (containing the modeling item) in the Registry Browser and close this dialog.</p> <p>You will be prompted for a password if the Storage is password protected; enter the 'Complete Access' or 'Read-Only Access' password and click on the OK button to view the Storage contents.</p>

Auditing

Enable a Transcript of Model Changes Over Time

Auditing records model changes, including when the change occurred and who made it. It records changes to Packages, elements, features, connectors and diagrams, detailing the creation, modification and deletion of these items. A Repository Administrator or Librarian typically enables auditing during selected project phases, or continuously during the lifetime of the repository. An Enterprise Architect repository contains important organization information and ensuring that changes to the models are consistent with an organization's intention and governance principles is critical to the success of this important information asset.

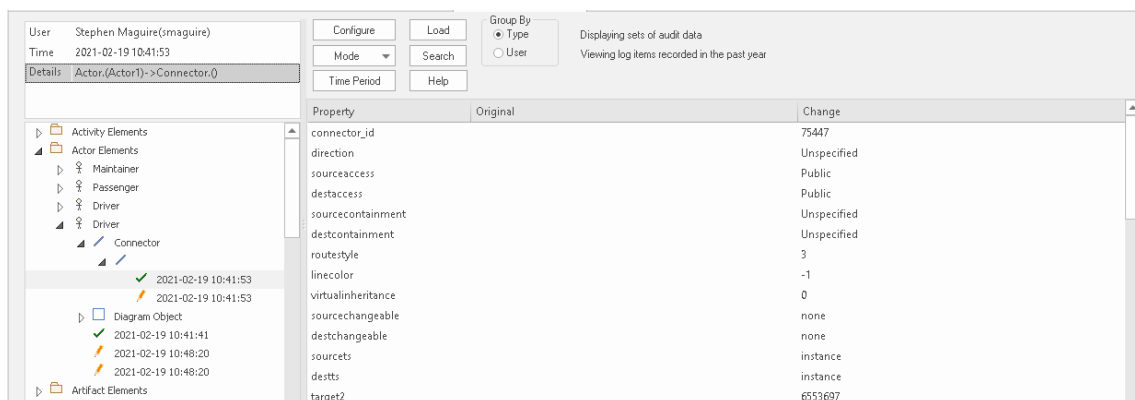

Audit View window showing the creation and change of a 'Driver' Actor element and its properties.

Audits are a practical model management mechanism ensuring that changes to models are well understood and governed. In this topic You will learn how to enable auditing, and using the Settings window define the level of

detail to record in the audit, the elements to be audited and how batch imports are handled. You can simply enable auditing and it will silently record the changes the users make to the model. You will also learn how to manage audit logs to ensure there are minimal impacts to performance as logs are stored. Auditing can be used for a variety of purposes beyond governance for example arresting sub-standard modeling practices by identifying the user and providing them with training and guidance of how to model in a given context.

Brief Introduction

The Auditing facility in Enterprise Architect allows changes to the repository to be recorded to an Audit log. This governance tool can be profoundly useful in finding out who changed a model and when it was changed. It is also useful to see the complete list of changes made by a given user or the list of changes made to a given element. The Audit View is a dashboard that allows you to display the before and after values of item properties and to drill down from Package level through elements, features and connectors to diagram objects.

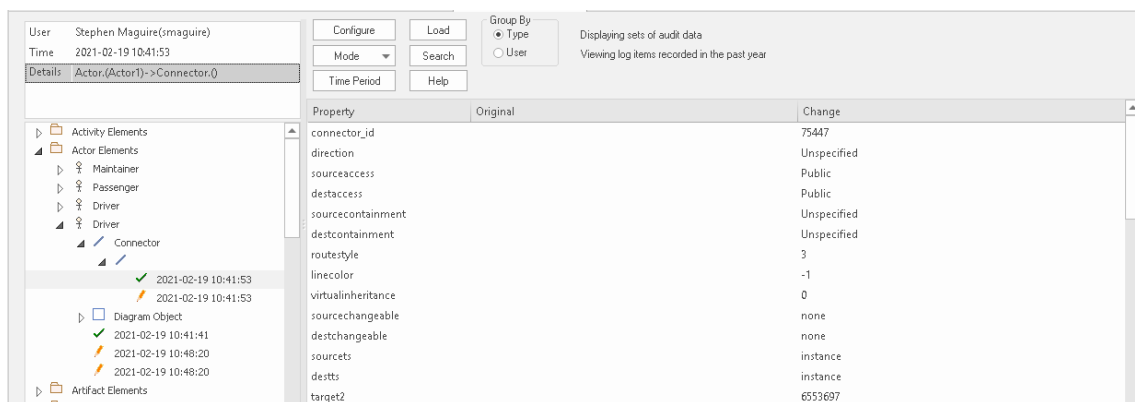

Audit View showing the creation of, and two subsequent changes to, the Diagram Object for a Driver Actor.

The basic steps to record Audit logs of the changes to a repository are:

1. Enable Auditing - this initiates the process of changes being written to the Audit log.
2. Configure Audit Settings - set the Audit Level and the Audit Options that define which elements will be audited, and set options for importing and reverse engineering.

3. Allow models to be changed - users perform their normal modeling, creating, modifying, and deleting elements, features and diagrams.
4. View the Audit log - to visualize the changes that have been made since the last log clearance.
5. Save and Clear logs - logs can be cleared to increase performance that degrades as the logs fill up.
6. Disable Auditing - optionally Auditing can be disabled if no longer required, and re-enabled when required.

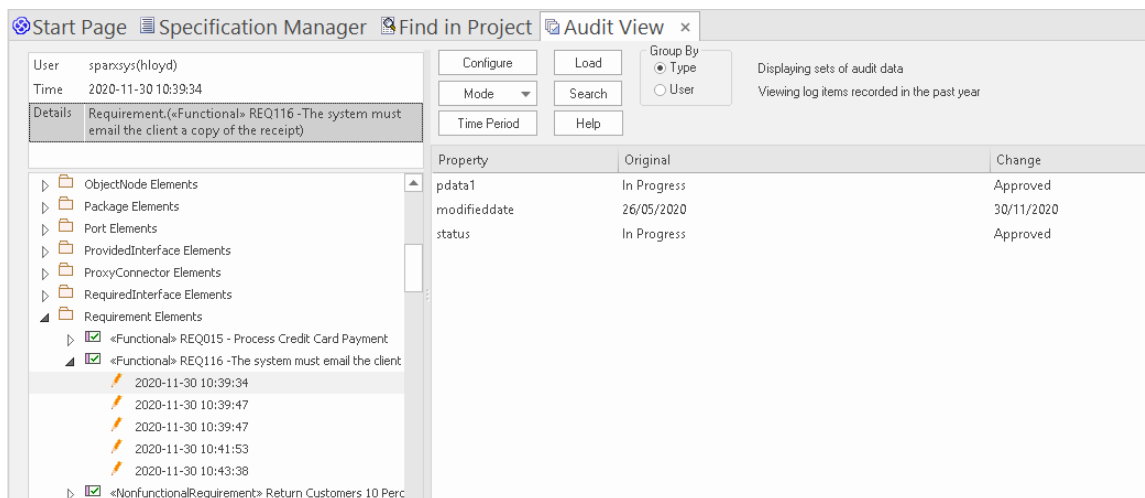

Audit View showing changes made to a Requirement's 'Status' property, from 'In Progress' to 'Approved'.

It is important to point out a fundamental difference between Auditing and Baselines and Version Control. While all three of these facilities are concerned with changes to a repository over time, with Auditing it is not possible to revert the model to a previous state, which is possible with Version Control and Baselines. In contrast with a Baseline Compare, which only displays the original value and the

current values of an item property, the Auditing View can display all the incremental changes over time, including when they were made and who made them.

Setting up Auditing is a simple process, and once set up it will begin recording information about what is changed in the repository based on the settings that you have specified. The next few sections provide the basic steps so that you and your teams can get started with Auditing and controlling changes to your repository.

Enabling Auditing

You can, as a Librarian or Administrator, enable Auditing, which initiates the process of model changes being written to the Audit log. You might choose to only enable Auditing for a period of time, such as when a new modeler joins the team or when contractors have access to the model, or in the final stages of a sprint or iteration.

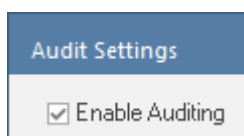

Audit Settings window, allowing Auditing to be enabled or disabled.

Auditing can be disabled at any time and enabled again at a later time. The logs, if not cleared, will simply be added to once Auditing is re-enabled.

Configuring Settings

The configuration of the Audit facility is an important step in setting up the tool, to ensure that the changes that you want to be able to visualize will be recorded in the Audit log and will be available when the time comes to view them. There are three main parts to the configuration:

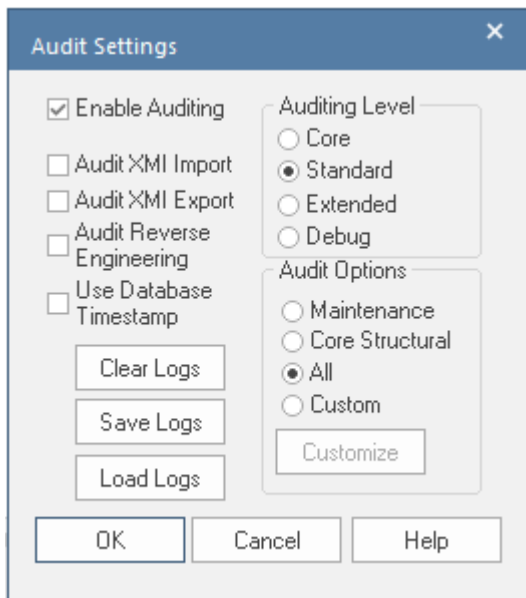

Audit Settings window, showing Auditing Level, Options, and Batch import and Log settings.

- Import and Reverse Engineering options - allow you to specify whether these bulk items should be recorded in the Audit log
- Auditing Level - You can specify the extent of the information recorded
- Auditing Options - You can specify which elements will be audited

Viewing Audits

As a Librarian or Administrator, you can view the content of

the Audit either through the View Audit window or in the System Output window. The Audit View provides a number of options for changing the display and provides a convenient Tree View control for navigating through the changes.

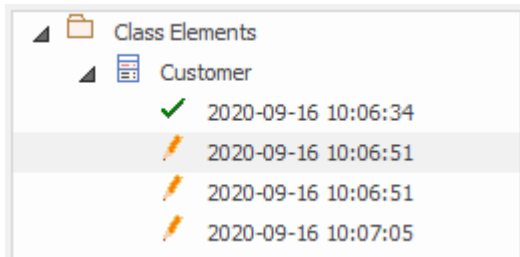

Audit View window showing the tree of items and their changes.

Changes are listed in time order, with an icon that indicates if the change was a creation, modification or deletion. A panel on the right displays the change itself, while the header section at the top describes who made the change, when it was made and the nature of the changes.

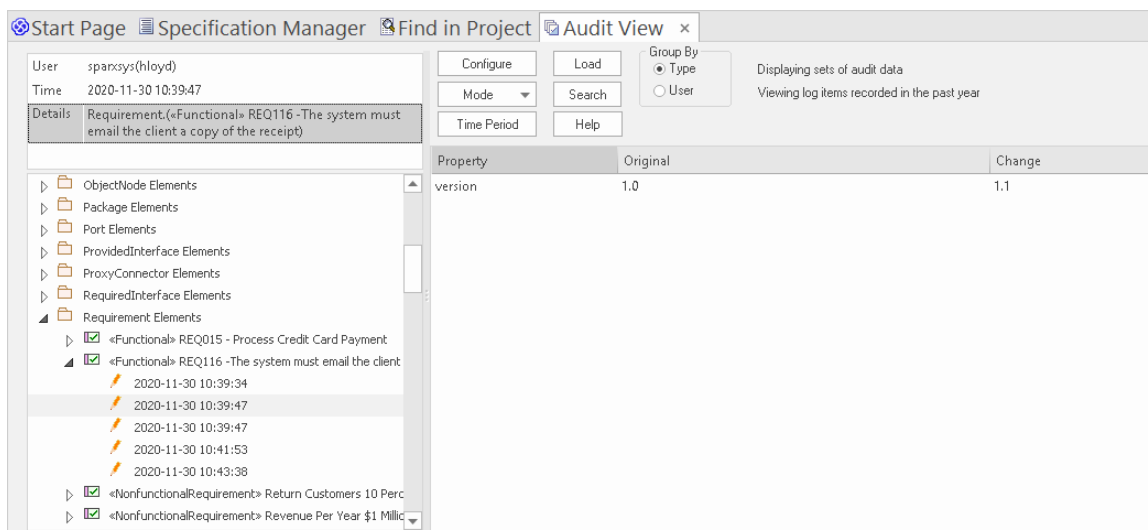

Audit View window showing changes to a Requirement's properties

Disabling Auditing

As a Librarian or Administrator you can disable auditing, which terminates the process of model changes being written to the audit log.

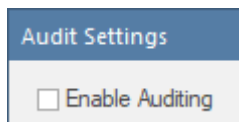

Audit Settings window allowing Auditing to be enabled or disabled.

Auditing can be enabled again at any point in time when required. The logs, if not cleared, will simply be added to once auditing is re-enabled.

Managing Logs

When Auditing has been enabled, changes to the elements specified in the audit options are recorded in an audit log. The management of logs is critical to the performance of the Auditing facility. When the logs fill up, the time it takes to write a change will increase, subtly degrading the performance experienced by modelers as they work in the repository. The management of logs can ensure that users don't notice any perceivable change in their save times. As the Administrator or Librarian you can save the logs to a network file and then clear the logs. It is recommended that this process is managed to ensure an optimal user experience. The logs can be managed from the left hand

panel of the Audit Settings window.

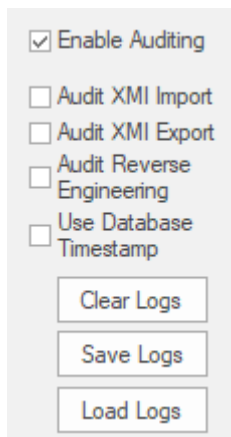

Audit Settings options to Clear, Save and Load Logs.

Audit Settings

The Audit Settings window allows you to enable or disable auditing, but in addition there are a number of options that you can use to manage what is recorded by the Auditing facility. These can be altered during different sessions of auditing; for example, you might only want to record limited information about requirements during a phase of the project. Subsequently you might require detailed information about all element types, and you could adjust the settings to specify this. The important options are summarized here:

- Define whether bulk operations should be included in the audit
- Administer your audit records such as saving and clearing logs
- Specify the detail of the recorded audit by specifying the audit level
- Specify the types of object to be included in the audit

Access

Ribbon	Settings > Model > Auditing : Audit Settings
--------	--

Configure Settings

Option	Action
Enable Auditing	Select this checkbox to turn the Auditing facility on. (Clear the checkbox to turn Auditing off again.)
Audit XMI Import	Select this checkbox to audit changes arising from XMI importing. As Version Control uses XMI, you must select this option to record changes from checking out Packages.
Audit XMI Export	Select this checkbox to audit changes arising from XMI exporting. As Version Control uses XMI, you must select this option to record changes from checking out Packages.
Audit Reverse Engineering	Select this checkbox to audit changes arising from reverse engineering.
Use Database Timestamp	Select this checkbox to use the database server's timestamp instead of each user's local timestamp; this improves security. This option is not available for file-based

	repositories.
Clear Logs	<p>Click on this button to permanently delete all log data from the current project; use the Save Logs button first, to save the audit records outside the project.</p> <p>The system prompts you to specify whether to clear items logged over a specific period of time.</p> <ul style="list-style-type: none">• Click on the No button to clear all log items currently held in the database• Click on the Yes button to display the 'Time Filter' dialog, on which you select a standard time period or define your own <p>This function can be accessed through the Automation Interface.</p>
Save Logs	<p>Click on this button to save a copy of the logged audit items currently held in the project. These items remain in the project; you can use the Clear Logs button to remove them.</p> <p>The system prompts you to specify whether to save items logged over a specific period of time.</p> <ul style="list-style-type: none">• Click on the No button to save all log items currently held in the database

	<ul style="list-style-type: none"> Click on the Yes button to display the 'Time Filter' dialog, on which you select a standard time period or define your own <p>This function can be accessed through the Automation Interface.</p>
Load Logs	<p>Click on this button to load a previously saved set of logs back into the project. A browser displays through which you select the log file to reload.</p> <p>If the same record exists in both project and log file, that record is not reloaded.</p>
Core	<p>Select this radio button to record changes to elements (including attributes and operations), Packages, connectors and some model-level information.</p>
Standard	<p>Select this radio button to record the same changes as for the Core option, plus changes to some of the 'housekeeping' data for diagrams - Name, Author, Version, Stereotype, Notes and Date Modified.</p> <p>You can check for changes to diagram content and structure using the Baseline facility for reviewing visual changes to diagrams.</p>

Extended	Select this radio button to record the same changes as for the 'Standard' option, plus changes to project security.
Debug	Select this radio button to record the same changes as for the 'Extended' option plus changes to any database tables. Some of the auditing information will not be visible unless the Audit View mode is set to 'Raw'.
Maintenance	Select this radio button to audit changes to maintenance elements only; that is: <ul data-bbox="518 1070 965 1630" style="list-style-type: none">• Package (element)• Requirement• Feature• Use Case• Actor• Note• Issue and• Change
Core Structural	Select this radio button to audit changes to maintenance elements plus certain structural elements; that is: <ul data-bbox="518 1899 981 2020" style="list-style-type: none">• Package (structure)• Class

	<ul style="list-style-type: none"> • Interface • Signal • Node • Component • Artifact • Part • Port and • Device
All	Select this radio button to audit changes to all types of element.
Custom	<p>Select this radio button to audit changes to element types that you specify.</p> <p>The Customize button is made available; click on this button to display a list of element types, and select the checkbox against each element type to include in the audit (or click on the Select All button to select every element type).</p> <p>Click on the OK button to save the selection.</p>

Notes

- As the number of records increases, the performance of

the Audit View reduces; it is recommended that audit records that are not regularly required are saved to file, then cleared from the project, to help ensure high performance

- Connectors are audited when they are connected to an element that is included under the Audit Options
- If security is enabled, you must have 'Audit View' permission to turn Auditing on, and 'Audit Settings' permission to change the audit settings

View the Audits

As an Administrator or Librarian you can view the changes that have been made to the items in the repository. The changes that are recorded depend on three main settings:

- Import and Reverse Engineering options - allow you to specify whether these bulk items should be recorded in the audit log
- Auditing Level - You can specify the extent of the information recorded
- Auditing Options - You can specify which elements will be audited

There are two different views of the changes that are available to you:

- The Audit View - a fully featured window that allows you to navigate through the changes and change the display
- The System Output window, 'Audit History' tab - a textual display that changes as the element context changes

Audit View

The Audit View provides a convenient dashboard of information that allows an administrator or librarian to view and manage the changes to the information that have been recorded by Auditing. A tree view control provides a quick way to navigate through a branch of the repository, showing all the items that have been changed. Colored icons provide a quick visual queue as to whether a particular item has been created, changed or deleted. When a change is selected in the tree view, the panel to the right displays the properties that have been created, modified or deleted, and the top panel shows the user responsible, the time and date of the change and a summary of the change.

Access

Ribbon	Settings > Model > Audit
--------	--------------------------

Sections of the Audit View

The Audit View is divided into three main areas:

Section	Description
View controls	The view controls provide a variety of settings for controlling auditing and the

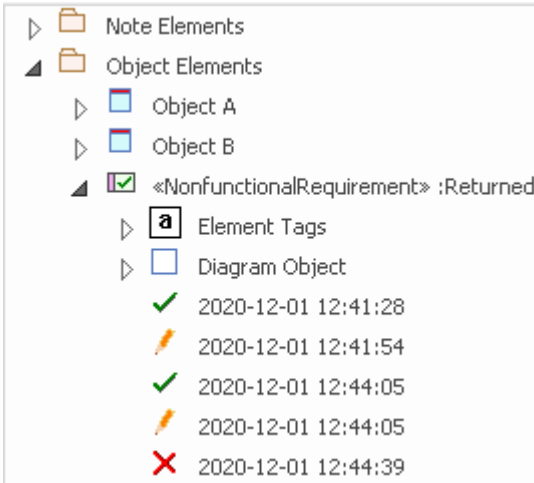
	display of audit records.
Audit tree	<p>The audit tree displays the log items that have been recorded by auditing.</p> <p>What is displayed in the tree is affected by the view controls, such as:</p> <ul style="list-style-type: none">• Sorting• Filter (by time)• Mode• Auditing settings (what was actually recorded) <p>If synchronizing with the Browser window, it is also affected by the Package, diagram or element you have selected.</p>  <p>In the audit tree:</p> <ul style="list-style-type: none">• The green tick indicates a creation• The yellow pencil indicates an edit• The red cross indicates a deletion <p>Right-clicking an element in the audit</p>

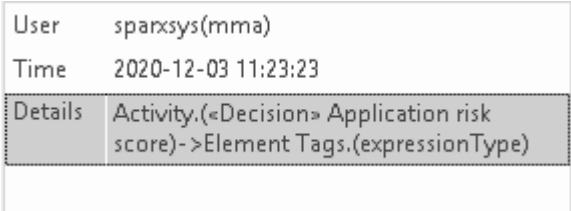
	<p>tree (such as ObjectB) displays a context menu that enables you to locate the selected element in:</p> <ul style="list-style-type: none"> • The Browser window • Any diagrams in which it exists
<p>Record display</p>	<p>The record display is in two parts: the identity of the selected change, and the actual change made.</p> <p>The data in the record display is determined by the view controls and mode and, if synchronizing with the Browser window, by the Package, diagram or element you have selected.</p> <p>Identity</p>  <p>The identity of a change consists of:</p> <ul style="list-style-type: none"> • The Windows username of the user who made the change; if security is enabled, the name is of the format WindowsUsername(SecurityUser) • When the change was made • The path of the change; for example: <i>Class Class1 - Attribute Att1 - Attribute Constraint Constraint</i>

Changes

Changes are displayed in a table format, showing the:

- Property (or data item) name
- Its original value before the change and
- Its value after the change

If you double-click on an item in the list of changes (or right-click and select the 'Show Differences' option) the Difference window displays:

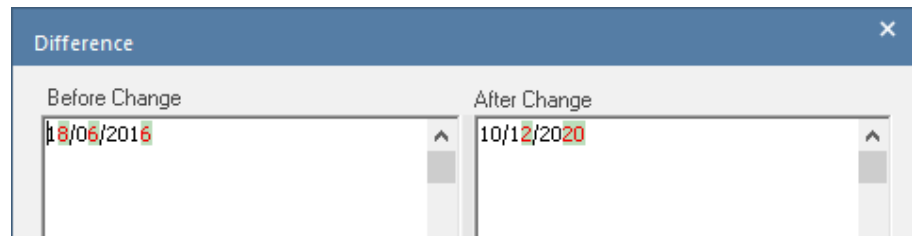

This shows the specific changes that have been made, highlighting the edited, created, deleted or formatted characters.

Changes to the format of text in the element, made through the element 'Properties' dialog, are not apparent in the initial table; they are visible in the Difference window, identified by HTML formatting tags.

Notes

- If security is enabled, you must have 'Audit View'

permission to display data in the Audit View

Audit View Controls

The Audit View controls provide a variety of settings for controlling auditing and the display of audit records.

Options

Option	Action
Configure	Click to open the 'Audit Settings' dialog.
Load	Click to reload the Audit Tree, updated with any new audit results.
Mode	<p>Click to display a menu of options to change the mode of the Audit View.</p> <p>Select:</p> <ul style="list-style-type: none"> • 'Default View' - to load large sets of log items independent of the Browser window; in this mode, a special Audit Settings group can be displayed in the Audit Tree, which records: <ul style="list-style-type: none"> - When Auditing has been enabled and disabled - Who made the change - The date and time of the change - Changes to the Audit Settings - When Audit Operations are

executed

- Security changes (which can be browsed in the same way as other changes)
 - 'Filtered to Browser' - to automatically synchronize with the Browser window; where changes have been made, the Audit View reflects your selection from the Browser window - if you click on:
 - An element, the Audit View displays the history for that element
 - A Package, the Audit View displays the history for that Package and its immediate children (but not the contents of nested Packages)
 - A diagram, the Audit View displays the history for that diagram and its contents (which could be drawn from a wide area of the Browser window)
 - 'Sequential Event Log' - to display all audit records in chronological order without sorting, enabling you to see a progression of changes; this can be especially useful in determining date-time inconsistencies
- Any search and filtering you define still

	<p>apply, enabling you to view all of today's changes in order, or all changes for a particular element in order, or both</p> <p>Additional database information is displayed; this additional information might be insignificant or only in machine-readable format</p> <ul style="list-style-type: none"> • 'Deleted' - to display only deleted records, but otherwise data is shown as in 'Default' mode; records can be sorted by element type or by user as required
<p>Search</p>	<p>Click to search through log items for a particular area - you can search by Name, Type or GUID.</p> <p>The items are loaded and filtered with the current Group By, Time Period and Mode settings.</p> <p>If you refresh the Audit View, you must run the search again.</p>
<p>Time Period</p>	<p>Click to display the 'Time Filter' dialog, to set the filter time period:</p> <ul style="list-style-type: none"> • Today - to display changes occurring today • Previous Hour - to display changes occurring in the last 60 minutes • Previous 24 Hours - to display changes

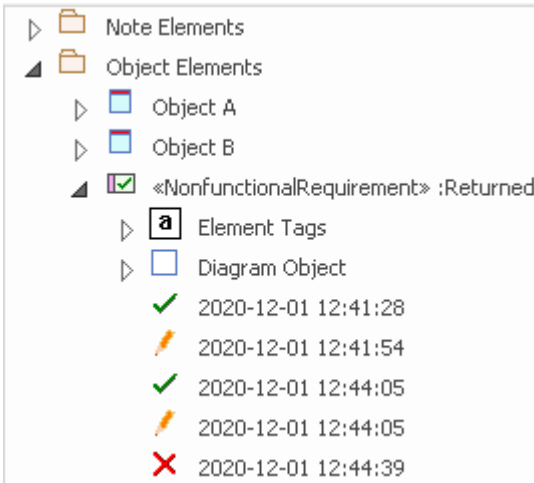
	<p>occurring in the last 24 hours</p> <ul style="list-style-type: none"> • Previous Week - to display changes occurring in the last 7 days • Previous 30 Days - to display changes occurring in the last 30 days • Previous Year - to display changes occurring in the last 365 days • Custom - to define your own time period, using the From and To fields <p>The six pre-configured time periods automatically update when you click on the Refresh button; custom periods are static and do not automatically update.</p>
<p>Group By</p>	<p>Select the appropriate radio button for the required display setting:</p> <ul style="list-style-type: none"> • Type - changes are grouped under element type (such as Class or Requirement), and then grouped under the changed element 

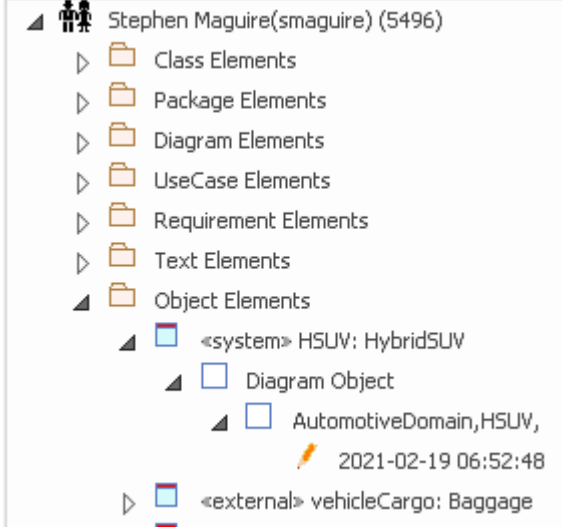
	<ul style="list-style-type: none"> • User - changes are grouped under user name, each with the number of changes for that user <p>Under each user name, changes are grouped as for the Type sort</p> 
<p>Status Text</p>	<p>(Displayed to the right of the 'Group By' panel) Read to see which:</p> <ul style="list-style-type: none"> • Mode has been selected and • Time filter is being applied to the data

System Output - Audit History

When Auditing is turned on, an 'Audit History' tab is added to the System Output window. The tab shows a history of changes to whichever element or connector you have selected in the:

- Current diagram
- Browser window
- Audit View, or
- Package Browser

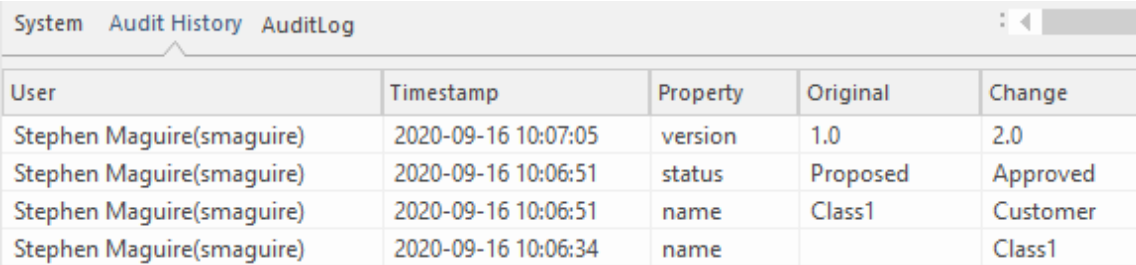

User	Timestamp	Property	Original	Change
Stephen Maguire(smaguire)	2020-09-16 10:07:05	version	1.0	2.0
Stephen Maguire(smaguire)	2020-09-16 10:06:51	status	Proposed	Approved
Stephen Maguire(smaguire)	2020-09-16 10:06:51	name	Class1	Customer
Stephen Maguire(smaguire)	2020-09-16 10:06:34	name		Class1

System Output window 'Audit History' tab showing changes to the elements in the repository.

As you select different elements or connectors, the 'Audit History' tab automatically updates to reflect your current selection. For each change made to the element or connector, the tab shows:

- Who made the change
- When the change was made
- Where the change was made
- The value of the characteristic before the change
- The value of the characteristic after the change

Access

Ribbon	Start > All Windows > Design > Explore > System > Audit History
--------	---

Notes

- To see this tab, you must first have the Audit View open; the tab continues to display if you subsequently close the Audit View
- If security is enabled, you must have 'Audit View' permission to display data on the 'Audit History' tab

Performance Considerations

Auditing is a tool for determining who made changes to the model and when the changes were made. When auditing has been enabled, every time a change is made to the model the Enterprise Architect auditing engine records the change. These changes will naturally, as for any transaction system, take some time to be written to the audit log. When the logs are small this write time will be imperceptible but when the logs grow in size the time taken to write to the log will increase and could delay the saving of changes. The tool provides a number of ways to reduce these delays in saving changes. The delays can be experienced in two different parts of the auditing process:

- **When making changes to the repository** - As described earlier, saving model changes could be delayed, affecting you or any other user who is updating an aspect of the model that is being audited; for example, a change to an element's name, changing the position of an object on a diagram or - if configured - the creation of tables or code classes resulting from reverse engineering a database or code package, will all result in a write to the audit logs
- **When accessing the Audit View** - The Audit View that is typically accessed by a Librarian or Administrator can become slow due to the volume of audit records that have to be sorted and displayed

The performance of both these aspects of the auditing process is discussed in these topics:

- *Auditing Performance*
- *Audit View Performance*

Auditing Performance

Enabling auditing on a project increases the time taken for many actions, such as insertion, change and deletion of objects and changes to properties of elements, connectors and diagrams, including moving objects in diagrams. When auditing is initially enabled, the time required to write to the audit logs will be almost imperceptible, but as the logs grow in size the log write time will become longer and could cause some frustration to you or your colleagues, whose main focus is creating useful models. Fortunately there are some simple housekeeping and administration procedures that can reduce this time, typically performed by a Librarian or Administrator.

Operation Delays

Operation	Detail
Large Deletions	Deleting large Packages or Package structures, or large numbers of elements, takes significantly longer with auditing on. You might disable auditing before performing such a deletion.
XMI Imports	Importing XMI takes longer with auditing enabled.

	<p>A project-level option is provided for disabling auditing of XMI Imports.</p>
<p>Reverse Engineering</p>	<p>Reverse engineering code takes longer with auditing enabled.</p> <p>A project-level option is provided for disabling auditing of reverse engineering.</p>
<p>Replication</p>	<p>You cannot remove replication from a model with Auditing enabled.</p> <p>If you have to remove replication, disable Auditing and - if prompted to do so - allow Enterprise Architect to roll back the database version; you can then remove replication.</p>

Audit View Performance

As the logs become larger, the Audit View can exhibit slow performance simply because of the volume of records it has to process to create the visualizations used by the Librarian or Administrator. Fortunately there are ways to reduce the delay in the presentation of changed items, and these only require a small amount of housekeeping.

Considerations and Responses

Consideration	Detail
Navigating the Browser Window Within Auditing is Slow	<p>Try setting the time period to a period in the immediate past, such as 'Today', 'Previous 24 Hours' or 'Previous Week'; this time period updates each time you open or refresh the Audit View.</p> <p>Save log items outside the project with the Save Logs button; if you then clear the logs you have just saved, the load time of the Audit View is reduced.</p> <p>You can reload logs into the project at any time, using the Load Logs button.</p>
The Audit View is Slow	As for 'Navigating the Browser Window Within Auditing is Slow'.

in Loading and Changing Modes	
Navigating the Audit Tree is Slow	Close the 'Audit History' tab in the System Output window.

More Information

Enterprise Architect's Auditing facility is a valuable governance tool that records repository changes in an Audit log. This functionality is immensely beneficial for tracking model modifications, identifying the user responsible for a change, and pinpointing when the change occurred.

Additionally, the Audit log provides insights into a user's complete list of changes or the alterations made to a specific element. The Audit View serves as a dashboard, showcasing before and after values of item properties and enabling users to navigate from Package level down to diagram objects through elements, features, and connector

Edition Information

- The Auditing facility is available in the Corporate, Unified and Ultimate editions
- Warning - If your site uses the Professional edition of Enterprise Architect (in which Auditing is not available) as well as the Corporate, Unified and/or Ultimate editions, when Auditing is turned on in a project any users of the Professional edition are locked out of that project; to restore access, turn Auditing off

Related Tools

- [Version Control](#)
- [Baselines](#)

- [The Compare Utility \(Diff\)](#)

-

Version Control

Stores Versions of parts of a Repository for Comparison and Rollback

Version Control provides a mechanism to store previous versions of any section of a model and later compare them to a current state. Version Control is a useful team feature that allows models to be developed in a coordinated way within a team environment. Sections of the model can be placed under Version Control and you can manage changes to and revisions of your model content by placing individual model Packages, view nodes or root nodes under Version Control. The information stored within the repository is a valuable corporate asset and needs to be managed as such.

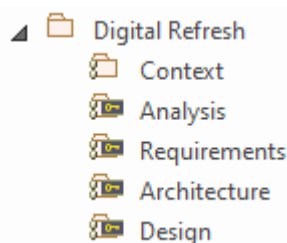

Browser window showing one Checked-Out Package (Context) and four Checked-In Packages under Version Control.

Version Control provides a safeguard against losing previous model changes. In this topic you as the Librarian will learn how to configure a Version Control product for use within Enterprise Architect and to apply the configuration to control Packages, individually or in groups. You will also learn how to use Version Control to

Check-Out and Check-In Packages, how to view previous versions, and compare a current version to a previous version.

Brief Introduction

The Version Control feature allows you to check-out a Package, which then locks it so that no other user can modify it until you have checked it back in again. You can then modify the Package, adding new elements and diagrams, changing others and deleting still others. When you have completed your changes and are ready for other modelers to see your work, you can check-in the Package. Other modelers would then need to do a Get Latest to pull the new changes down from the Version Control Server.

Enterprise Architect does not version the Packages internally; instead it integrates with industry standard Version Control servers, which an administrator must install and configure for use by Enterprise Architect. The files that Enterprise Architect uses are industry standard XMI files, which are best seen as 'binary' from the point of view of Version Control. This means that it is not possible for two modelers to be working on the same file, as it would not be possible to merge the files as is possible with source code or text files.

The basic steps to use Version Control are:

1. Select and set up a Version Control Server and Client side Software.
2. Place the required Packages under Version Control.
3. Check Out a Package.
4. Make modifications to the contents of the Checked Out Package.

5. Check In the Package, entering comments that describe the changes.
6. Compare the Repository Package with the Version Controlled Package.
7. Retrieve (rollback to) a previous version.

Enterprise Architect's Version Control integration provides several key facilities, including:

- Saving a history of changes made to your model's Packages
- Retrieving previous revisions of Packages
- Propagating model updates between team members
- Coordinating the sharing of Packages between team members

Commissioning a Version Control System

You apply Version Control through a third-party source-code control application that manages access to and stores revisions of the controlled Packages. Once the Version Control software has been installed and configured, you or a librarian must define a Version Control Configuration within your project. You can then use Version Control to manage changes to the Packages of your model.

Configuring Packages

Before you can Check Out a Package and begin making changes, you or the librarian must first configure the Package for Version Control. You simply select the 'Add Branch to Version Control' option and choose an existing configuration. This adds the Package to the Version Control System and places it in a Checked-In state.

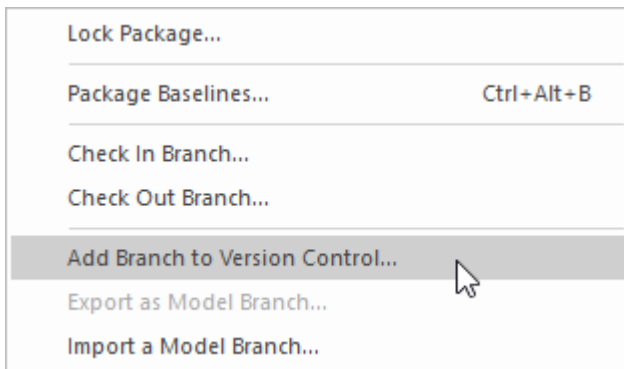

Context menu showing the 'Add Branch to Version Control' option.

Packages under Version Control are identified in the Browser window by icons that indicate the current status of the Package. When a Package is initially added to the Version Control System it will have a locked icon, as shown in this diagram.

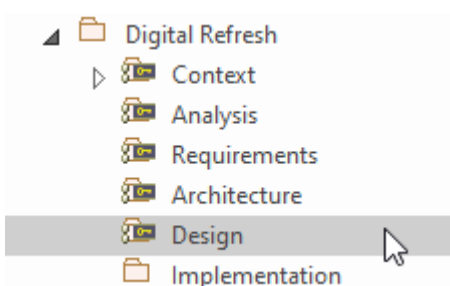

Browser Window showing the Design Package with a Lock icon after Check-In.

Checking Out Packages

Once Version Control has been set up and configured you can start checking out Packages. When you want to work on a Package that is Version Controlled, you need first to Check Out that Package. This will change the Package icon in the Browser window from locked to unlocked. While you have the Package checked-out no other user will be able to work on the Package and they will in turn see a locked Package icon.

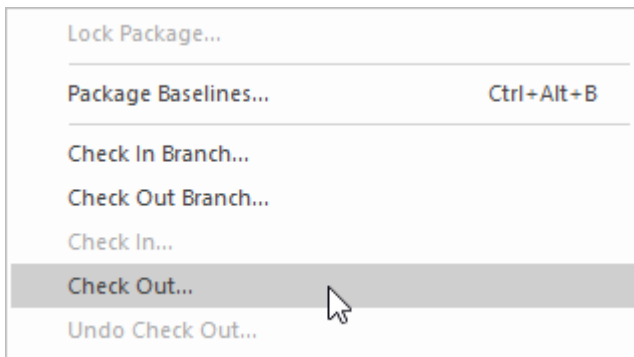

Context menu showing the Check Out option.

Make Modifications to Package Content

Once a Package has been checked out you are free to make modification to the content, just as you would in a repository that doesn't have any Version Control implemented. You will be the only one able to edit the content, as other users that attempt this will receive a message saying the Package is checked out.

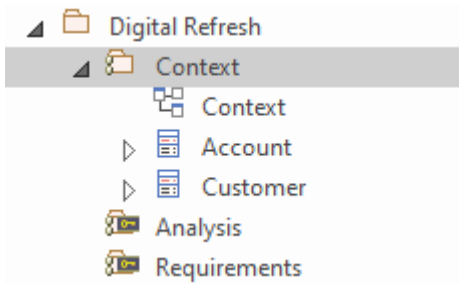

Browser window showing the Context Package that has been checked out, with the Checked-Out Package icon

Checking In Packages

Once you have finished making changes to the contents of a Checked-Out Package, you can Check In that Package. This will change the Package icon in the Browser window from unlocked to locked. As soon as you Check-In the Package it will display a locked Package icon and the Version Control system will be updated. You can also enter a comment that describes the changes that you made while the Package was under your control, which will be useful when looking back at version changes. Once the Check-In is complete, other users will be able to Check-Out the Package.

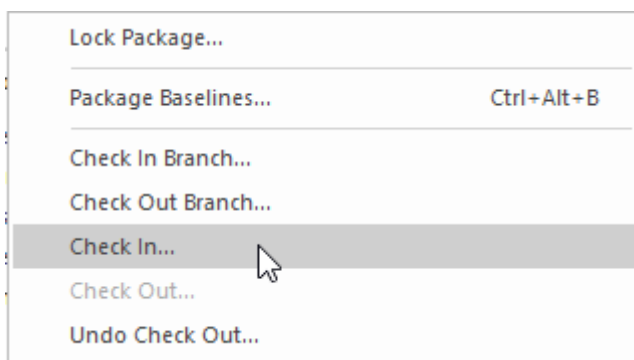

Context menu showing the Check In option.

Getting Latest Changes

If you are working in a single shared model any changes that your colleagues have made will be available by simply reloading the Package. If, however, you are working in private models then you will need to periodically get the latest changes that your colleagues have checked in to the Version Control system. You can use 'Get Latest' for a single Package or for the entire model depending on whether you are interested in just one change or all of the changes.

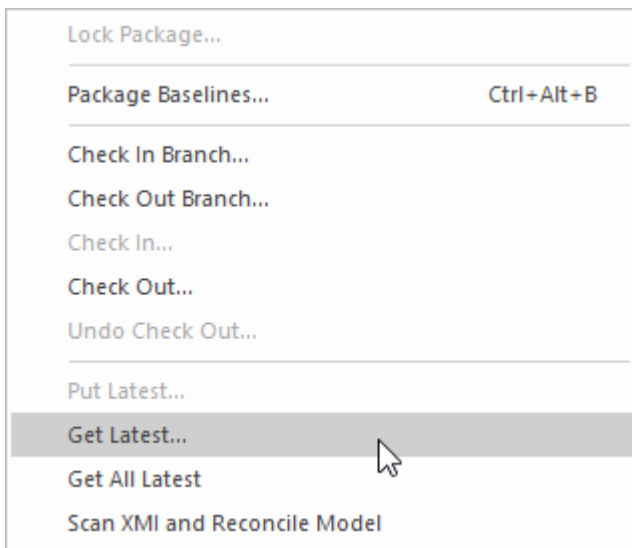

Context menu showing the 'Get Latest' option.

Comparing to Previous Version

At any stage of a model's evolution you can compare the current version of a Package to the version stored in the Version Control system. This option launches the Comparison window that displays the differences between the model's current state and the latest revision held in the

Version Control system.

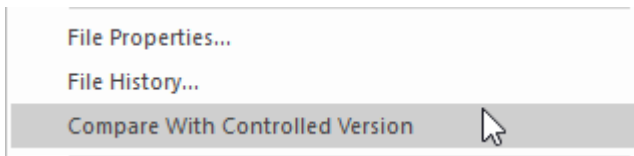

Context menu showing the 'Compare with Controlled Version' option.

Reverting to a Prior Version

As your model evolves you might want to revert to a previous version of a Package. By using the 'File History' dialog you can select any prior version. By viewing the Check-In comments and the Date and Time of the Check-In the required version can be selected. The Retrieve option will restore the current model to the selected version without the need to check-out the Package.

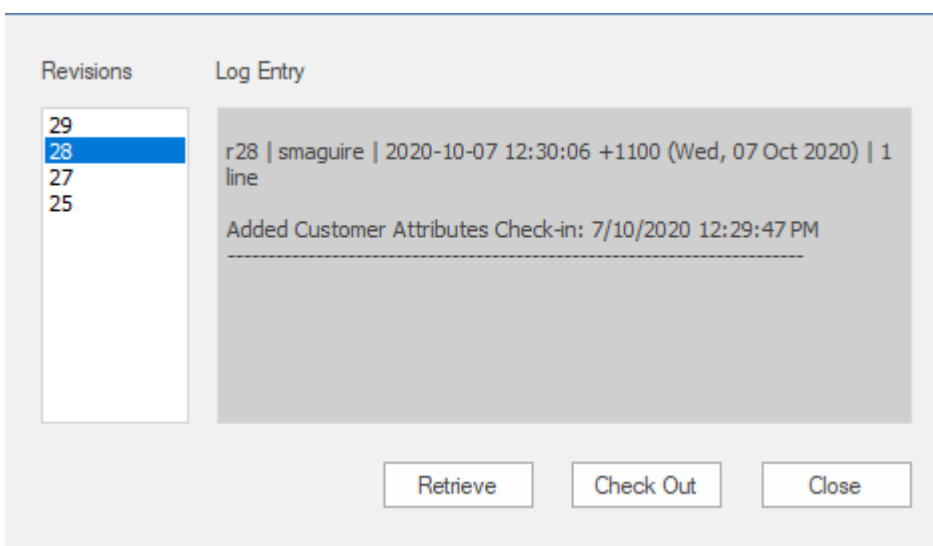

File Version History window showing a number of versions (revisions) with Comments.

Setup Options

There are a number of options that can be chosen when setting up Version Control for one or more teams in your organization. There are also some fundamentals about the way that Enterprise Architect integrates with the Version Control software with respect to locking that you should review before setting up Version Control.

Version Control Locking Overview

Enterprise Architect implements Version Control of your model by exporting Package data from the project database to XMI Package files, which are placed under Version Control in the source-code control application. The XMI file format cannot be merged in the same way as ordinary text files can be merged, which is why Enterprise Architect must enforce serialized editing of Version Controlled Packages, as discussed here.

The Lock-Modify-Unlock Solution

Many Version Control systems use a lock-modify-unlock model to address the problem of different authors in a shared source overwriting each other's work. In this model, the Version Control repository allows only one person to change a file at a time, and access is managed using locks. Harry must lock a file before he can begin making changes to it. If Harry has locked a file, Sally cannot also lock it, and therefore cannot make any changes to that file. All she can do is read the file, and wait for Harry to finish his changes and release the lock. After Harry unlocks the file, Sally can take her turn in locking and editing the file.

The Copy-Modify-Merge Solution

Subversion, CVS and a number of other Version Control systems use a copy-modify-merge model as an alternative to

locking. In this model, each user's client contacts the project repository and creates a personal working copy - a local reflection of the repository's files and directories. Users then work simultaneously and independently, modifying their private copies. In due course, the private copies are merged together into a new, final version. The Version Control system often assists with the merging, but ultimately a person is responsible for making it happen correctly.

When Locking is Necessary

While the lock-modify-unlock model is generally considered a hindrance to collaboration, there are still times when locking is necessary.

The copy-modify-merge model is based on the assumption that files are contextually merge-able: that is, that the files in the repository are line-based text files (such as program source code). However, for files with binary formats, such as artwork or sound, it is often impossible to merge conflicting changes. In these situations, it really is necessary for users to take strict turns in changing the file. Without serialized access, some users end up wasting time on changes that are ultimately overwritten.

Repository Options

The Version Control facility can be used in many different ways, although these roughly fall into one of four types of use as discussed in this table.

Usage

Type	Details
Single Shared model	<p>Users share a model stored in a central project file or DBMS repository. In this configuration you can view changes to other users' Packages without explicitly having to check them out, by simply refreshing your view of the model.</p> <p>Version Control is used to:</p> <ul style="list-style-type: none"> • Archive successive versions of your work to date • Maintain Package revision history • Recover from unwanted changes or accidental deletions, through an 'Undo' facility • Regulate access to Packages
Multiple Private	<p>One model is created by a single user who configures it for Version Control. The model file is then distributed to other</p>

models	<p>users, with each user storing their own private copy of the model.</p> <p>Version Control is used to:</p> <ul style="list-style-type: none"> • Propagate changes to the model, throughout the team • Archive successive versions of your work to date • Maintain Package revision history • Recover from unwanted changes or accidental deletions, through an 'undo' facility • Regulate access to Packages
Shared Packages	<p>Individual users create separate models but share one or more Packages:</p> <ul style="list-style-type: none"> • Users share Packages through Version Control
Standard Packages	<p>A company might have a standard set of read-only Packages that are broadly shared:</p> <ul style="list-style-type: none"> • Individual users retrieve Packages with the Get Package menu option

Factors to consider

Factor	Detail
<p>System Requirements and Configuration</p>	<p>You apply Version Control through a third-party source-code control application that manages access to and stores revisions of the controlled Packages.</p> <p>Typically the configuration consists of:</p> <ul style="list-style-type: none"> • A server component that manages a Version Control repository, and • Client components on the workstations, that manage local working copies of controlled files <p>Enterprise Architect uses the client component to communicate with the server. A Version Control client must be installed on every machine where you run Enterprise Architect and want to access your Version Control system.</p>
<p>Version Control Usage</p>	<p>There are two main ways in which projects can be deployed:</p> <ul style="list-style-type: none"> • Centralized Shared Model • Distributed Private Models <p>Version Control is employed in the same way for both scenarios; however, when using Private Model deployment you have the additional facility of propagating</p>

	<p>model updates throughout the team.</p> <p>Version Control can also be used to share standard Packages between different projects.</p>
Team Deployment	<p>Consider the process of setting up a Version Control environment and applying Version Control to a project to be accessed by a number of users.</p>
Version Control Basics	<p>Enterprise Architect enforces serialized editing of Version Controlled Packages, using the lock-modify-unlock mode of operation.</p>
Applying Version Control to Models	<p>Using Version Control consists of placing individual model Packages under Version Control, rather than Version Controlling the project as a whole.</p>
Version Control and Project Reference Data	<p>To share changes in reference data between users in a version-controlled project deployed as multiple private models, you periodically export the reference data from the model where the changes were made, and import it into the other models maintained by the team.</p>
Offline	<p>You can prevent the system from</p>

Version Control	<p>attempting to make any Version Control connections by choosing to Work Offline before loading a model.</p> <p>If Enterprise Architect is unable to connect a Version Control Configuration for any reason, it displays warning messages to notify you and provides 'offline' Version Control functionality for all Packages associated with the failed connection.</p>
------------------------	---

Version Control of Model Data

When applying Version Control in Enterprise Architect, you place individual model Packages under Version Control, and not the project as a whole.

All Enterprise Architect models are stored in databases - even the .eap file is an MS Jet database. In simple terms, the project file is a single entity of binary data. Being binary data, the project file would require the use of the lock-modify-unlock model of Version Control, which would mean that only a single user at a time could work on any given (Version Controlled) model. Therefore, it is not practical to apply Version Control to the database (.eap file) as a whole; this can also create problems for you in that:

- Most Version Control systems mark their controlled files as read only, unless they are specifically checked-out to you
- The .eap file is an MS Jet database, and Enterprise Architect must be able to open this file for read/write access when you load your model; if the model is read-only, the system displays an error message and fails to load the model

Version Controlling Packages in your Model

To overcome these limitations, Enterprise Architect exports discrete units of the model - the Packages - as XMI Package files, and it is these XMI files, not the project file, that are placed under Version Control. The XMI file format used by

Enterprise Architect dictates that they too be treated as binary files - therefore it is not possible to merge the XMI files either; however, by splitting the model into much smaller parts, many users can work on separate parts of the model simultaneously.

Version Controlled Nested Packages

Version Controlled nested Packages result in much smaller XMI files being exported, as the parent Packages' XMI files do not contain any content for the Version Controlled child Packages.

Version Control of nested Packages, together with a model structure of small individual Packages, provides greater scope for multiple users to work concurrently, as individual users are locking much smaller parts of the model.

Version Control Nested Packages

When you save a Package to the Version Control system, only stub information is exported for any nested Packages. This protects information in a nested Package from being inadvertently over-written by a top level Package.

Operations on Nested Packages

Operation	Detail
Checking Out	When you check out a Package, you do not modify or delete nested Packages; only the top level Package is modified. As a consequence of this behavior, if you check out or get a Version Controlled Package with nested Packages that are not already in your model, you see stubs in the model for the nested Packages only.
Get All Latest	If you select the 'Get All Latest' option from the Version Control menu, any new stubs are populated from the Version Control system.
Importing Models	You can populate a large and complex model, by 'getting' only the root

Packages, then using 'Get All Latest' to recursively iterate through the attached and nested Packages.

This is a practical and efficient means of managing your project and simplifies handling very large models, even in a distributed environment.

The 'Import a Model Branch' option combines the procedure steps into a single operation.

Notes

- It is recommended that, when sharing a Version Controlled model, you do not mix versions of Enterprise Architect later than version 4.5 with earlier versions; if this is necessary it is best to go to the 'Version Control Settings' dialog and deselect the 'Save nested version controlled packages to stubs only' checkbox, setting Enterprise Architect to the pre-version 4.5 behavior (for the current model only)

Version Control and Reference Data

Reference data is data that is used across a model or project; it is not Package-specific. Version Control operates at Package level, and therefore does not capture changes in reference data. Where Version Control is used in a multiple private model set up, changes in reference data are not brought into the model when Packages are updated from Version Control.

In a Shared Model environment, all users are accessing the same project reference data. Changes in reference data can be shared between users in a Version Controlled project deployed as multiple private models, by periodically exporting the reference data from the model where the changes were made, and importing it into the other models maintained by the team.

Reference data is exported and imported as an XMI file, which contains whatever types of reference data you want to transfer. You can place your project reference data under Version Control by exporting the data as an XMI file and apply Version Control to that file using your Version Control software external to Enterprise Architect.

Version Control and Teams

This is a summary of the process of setting up a Version Control environment and applying Version Control to a project to be accessed by a number of users.

Version Control - Process Overview

Step	Action
1	Install your Version Control product.
2	Create a Version Control repository.
3	Create a Version Control project to be used with your Enterprise Architect project.
4	<p>Check-out a working copy of the Version Control project (a module, project or folder within the Version Control system) into a local folder.</p> <p>You must do this for every team member that is accessing the Version Controlled Packages, whether you are using a single shared model or each team member stores his own private copy of the model.</p>
5	Before attempting to access the new Version Control environment from within Enterprise Architect, you

	<p>should first verify that it functions correctly when used outside of Enterprise Architect.</p>
6	<p>Within Enterprise Architect, define a Version Control configuration to provide access to the working copy files.</p> <p>The name of the Version Control configuration must be the same across all machines throughout a team. That is, all Version Control access to a given Package must be through Version Control configurations with the same name, across all models and all users.</p> <p>The easiest way to perform this step (throughout the team) is to have one user set up Version Control on the model and then share that model with the rest of the team.</p> <ul style="list-style-type: none">• In Shared Model deployment, all users connect to a single instance of the model database, so the model is shared automatically• In Private Model deployment, it is easiest to distribute copies of the original model (after Version Control has been set up) to all other members of the team <p>Whenever you open a model (Private or Shared) that uses a Version Control configuration that is not yet defined on your workstation, a prompt displays to complete the definition for that configuration. This typically means specifying the local working copy directory and perhaps choosing the Version Control</p>

	<p>project associated with this Enterprise Architect project.</p> <p>Once this has been done, the Version Controlled Packages that already exist in the model are ready for use.</p>
7	<p>Configure Packages within the Enterprise Architect model for Version Control. That is, apply Version Control to individual Packages.</p>
8	<p>Check-out and check-in Packages as required.</p>

Notes

- It is possible to use multiple Version Control Configurations within the same model; different Packages can still use different Version Control Configurations within the model, as long as any given Package is always accessed via the same Version Control Configuration

Offline Version Control

When loading a model that uses Version Control, Enterprise Architect normally initializes a connection to the Version Control system for each Version Control configuration defined in the model. If Enterprise Architect is unable to connect a Version Control configuration for any reason, it displays warning messages to notify you and provides offline Version Control functionality for all Packages associated with the failed connection.

You can prevent Enterprise Architect from starting to make any Version Control connections, by selecting to work offline before loading your model.

Access

Ribbon	Settings > Version Control > Work Offline
--------	---

Working Offline

Concept	Discussion
Choosing to Work Offline	Selecting to work offline is useful if you know beforehand that Enterprise

	<p>Architect cannot connect to your Version Control system. For example: If you are working on a laptop computer that is disconnected from your network, on an Enterprise Architect model that uses a large number of Version Control configurations, you can select to work offline before you load the model to avoid all the error messages that the system would normally display as each Version Control connection attempt failed.</p> <p>You can switch between working offline and working online at any time, either before or after a model is loaded, by toggling the 'Work Offline' menu option. Enterprise Architect disconnects or reconnects Version Control (depending on the connection availability) according to your selection.</p>
Using Version Control Whilst Disconnected From the Version Control	Enterprise Architect 'remembers' the status of a model's Version Controlled Packages. Packages that were checked out to you prior to disconnecting from the server are still shown as checked out to you, even though you are no longer connected to the server. You can still edit these Packages as you normally would.

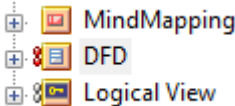
<p>Server</p>	<p>Packages that were not checked out to you prior to disconnecting from the server are shown as Version Controlled and locked. You cannot edit these Packages until you check them out.</p>
<p>Offline Check Out</p>	<p>You can 'check-out' and edit a Version Controlled Package even when your machine is disconnected from the Version Control server. In this example, the colored 'figure 8' icon for DFD indicates that you have checked it out whilst off line.</p>  <p>(The gray 'figure 8' icon shown against Logical View indicates that you have checked out a Version Controlled Package on line.)</p> <p>You should be aware that the Version Control system, and therefore other users, have no way of knowing that you have 'checked-out' a Package whilst offline. It is not possible to merge changes to an XMI file that result from two users editing the same Package at the same time. If an offline checkout leads to two</p>

	<p>people editing the same Package at the same time, when the changes are brought back online the first-saved set of changes is lost.</p>
<p>Checking In a Package That Was Checked Out Offline</p>	<p>Once you reconnect your system to the Version Control server, if the Package you checked out offline is not currently checked out by another user, you can check in that Package. However, before Enterprise Architect checks in the Package, it compares the local working copy of the Package file with the latest revision in the repository. (These Package files remain unchanged in your work area until Enterprise Architect exports the Package again before checking in.) If the repository version remains unchanged from when you last updated your local copy, Enterprise Architect exports and checks in your Package without further prompting.</p> <p>On the other hand, if the repository now contains a file that has changed since you last updated your local copy, checking in your Package would overwrite those changes. Enterprise Architect displays a message warning you of the pending data loss and giving you the opportunity to abort the check in. At this point, you must</p>

	<p>decide whether to discard your own changes, using the 'Undo Check Out' command, or continue with your check in and overwrite the changes that have been committed to the repository since you last updated your local copy from the repository.</p> <p>You can use the 'File Properties' command to determine who checked in the last changes to this Package. This might help you to discover what changes have been uploaded and decide whose changes take precedence.</p>
<p>Update Before You Disconnect</p>	<p>Whenever you are connected to the Version Control server, you are always working with the latest version of a Package. This is because you cannot modify a Package until you check it out from Version Control, and checking it out loads the latest revision from the repository into your model.</p> <p>This cannot happen when you are disconnected from the Version Control server. You are working on whatever versions you have on your machine, dating back to the last time you updated your local copy of each Version Controlled Package. So, if you are</p>

planning to work on a model whilst disconnected from Version Control, it is a very good idea to make sure that you have the latest versions of all Packages before you disconnect. The 'Get All Latest' option makes this a simple task.

Version Control Branching

Currently, Enterprise Architect does not support Version Control Branching.

Work-arounds to achieve similar results might be possible for certain version-control products; contact Sparx Support for advice.

Contacts

User Type	Contact via
Registered users	https://sparxsystems.com/registered/reg_support.html
Trial users	support@sparxsystems.com

Version Control Product Setup

To control and maintain the different revisions of your project Packages, Enterprise Architect uses third-party Version Control products. Once your Version Control product is installed and a suitable environment has been created, Enterprise Architect can use that environment to control your project's Packages.

Typically, Version Control products consist of:

- A server component
- A client component

Enterprise Architect integrates with the Version Control client components for Subversion, CVS and MS Team Foundation Server command line clients, as well as for products having API clients that comply with the MS SCCI specification.

Version Control System Components

Component	Detail
Version Control Server	<p>The server component maintains the controlled files in their many revisions, in a central repository.</p> <p>The server component is usually located on a server machine that is accessible to all team members who are using Version</p>

	Control.
<p>Server Configuration</p>	<p>The steps for configuring a Version Control server are, broadly:</p> <ul style="list-style-type: none"> • Install the software • Create a repository • Create Version Control projects (or modules or folders for use with specific projects) • Configure user IDs and passwords <p>For details on configuring any particular Version Control server, consult the appropriate documentation provided with the Version Control product.</p>
<p>Version Control Client</p>	<p>The client component manages the working copies of the controlled files, submitting files to or retrieving files from the server as required.</p> <p>A Version Control client must be installed on every machine on which you run Enterprise Architect and want to access your Version Control system.</p>
<p>Client Configuration</p>	<p>The steps for configuring a Version Control client are, broadly:</p> <ul style="list-style-type: none"> • Install the software • Create a new directory for use as a

	<p>local working copy folder</p> <ul style="list-style-type: none">• Log in to the Version Control server• Associate the working copy folder with its corresponding server repository folder <p>For details on setting up a product-specific Version Control environment for use with Enterprise Architect, click on the appropriate link in the next column.</p>
--	--

System Requirements

Enterprise Architect is a Windows-based application and requires a Windows-based Version Control client for integration. It is independent of the Version Control server component and the platform on which that runs.

Version Control Product Requirements

Product	Detail
Subversion	<p>Subversion is free, open source software. Subversion server components are available to run on a wide range of different hardware and operating systems. Enterprise Architect is not affected by your choice of server components, but requires Subversion's Windows-based command line client for integration.</p> <p>There are many graphical user interface clients available for use with Subversion, such as TortoiseSVN; this type of client cannot be used directly for integration with Enterprise Architect, but can be very useful in preparing a working Subversion environment for use by Enterprise Architect.</p> <p>Binary Packages are available for</p>

	<p>download from:</p> <ul style="list-style-type: none">• http://subversion.apache.org/packages.html <p>Subversion documentation is available from:</p> <ul style="list-style-type: none">• http://svnbook.red-bean.com/nightly/en/index.html
<p>Concurrent Versions System (CVS)</p>	<p>CVS is free, open source software.</p> <p>CVS server components are available to run on a wide range of different hardware and operating systems.</p> <p>Enterprise Architect is not affected by your choice of server components, but requires CVS's Windows-based command line client for integration.</p> <p>There are many graphical user interface clients available for use with CVS, such as TortoiseCVS; this type of client cannot be used directly for integration with Enterprise Architect, but can be very useful in preparing a working CVS environment for use by Enterprise Architect.</p> <p>The software is available for download from:</p> <ul style="list-style-type: none">• http://www.nongnu.org/cvs/ <p>CVS documentation is available from:</p>

	<ul style="list-style-type: none"> • http://cvsbook.red-bean.com/cvsbook.html
<p>Microsoft Team Foundation Server</p>	<p>Enterprise Architect is able to use either the:</p> <ul style="list-style-type: none"> • Command line client for TFS, or • MS TFS-SCC client <p>Your choice of client affects how you specify your Version Control Configuration.</p> <p>MS TFS-SCC clients are available for download from Microsoft's web pages. (Run an Internet search for 'TFS MSSCCI'.)</p>
<p>Common Source Code Control (SCC)-compatible products</p>	<p>Any Version Control product that provides a client that complies with the Microsoft Common Source Code Control standard, version 1.1 or higher, can be integrated with Enterprise Architect.</p> <p>These products are SCC-compatible and are known to successfully integrate with Enterprise Architect:</p> <ul style="list-style-type: none"> • Accurev • ClearCase • MS Visual Source Safe • MS TFS-SCC • MKS Source Integrity

- Perforce
- Source Offsite
- Snapshot CM

Products that do not appear in this list should still integrate successfully with Enterprise Architect, if there is a client available for that product that complies with the MS SCC API specification.

Create a Subversion Environment

You can use Subversion as a Version Control provider for Enterprise Architect. The first step in doing this is for a Subversion administrator to install and configure the appropriate software. A number of basic tasks are performed in creating an operational Subversion environment, and useful tools are available for performing some of these tasks.

Tasks in Creating a Subversion Environment

Task	Detail
Install server components	<p>Executable files for Subversion can be obtained from the Apache Software Foundation.</p> <p>Subversion server components are available to run on a wide range of different hardware and operating systems; Enterprise Architect is not affected by your choice of server components.</p> <p>VisualSVN is an application that can greatly simplify the installation, configuration and management of your Subversion server.</p>
Create a	Please consult the official Subversion

repository	documentation.
Create Subversion users	Please consult the official Subversion documentation.
Create a new repository sub-tree	<p>It is good practice to create a new repository sub-tree in Subversion for each new Enterprise Architect model being added to Version Control with Subversion. Users should create a new local working copy from the sub-tree to be used with that model.</p> <p>TortoiseSVN can greatly simplify the process of creating new repository sub-trees.</p>
Install client components	Executable files for Subversion can be obtained from the Apache Software Foundation.
Create a working copy folder	<p>A working copy folder must exist on each users' machine, for Enterprise Architect to use when exporting and importing the Version Controlled Package files. It is this folder that is specified as the Local Project Path, when defining your Version Control Configurations.</p> <p>The working copy folder is the 'sandbox'</p>

	<p>where you modify the controlled files. The working copy folder is usually associated with a folder that exists within the Version Control repository. In Subversion, to create a local working copy you perform an initial check-out of a folder from the Subversion repository; this downloads a copy of the folder and its contents, to create your local working copy.</p> <p>TortoiseSVN can greatly simplify the initial check out of a working copy folder.</p>
<p>Setting up Subversion under Wine/CrossOver</p>	<p>The process of setting up and using Subversion with Enterprise Architect under Wine is almost identical to the process when running natively under Windows, apart from minor differences in installing the Subversion client and performing the initial check out of the working copy folder.</p>

Notes

- Enterprise Architect relies on exclusive file locking when applying Version Control to its Packages; file locking was not introduced into Subversion until version 1.2, therefore

Enterprise Architect does not work with Subversion releases earlier than Subversion 1.2

- Enterprise Architect can only communicate with the Subversion server using the Subversion command line client `svn.exe`

Create a new Repository Sub-tree

When you set up Subversion as your Version Control tool, it is good practice to create a new repository sub-tree in Subversion for each new Enterprise Architect model. The sub-tree can be used to control the Package files for your model.

Create a new sub-tree in the Subversion Repository

Step	Action
1	Use Windows Explorer to create a temporary directory on your PC file system, to be imported into the Subversion repository as a new repository sub-tree. The directory would have this structure: <ul style="list-style-type: none">- tempDir myEAModelName
2	Open a Windows command prompt, navigate to <i>tempDir</i> and issue the Subversion command <i>import</i> . For example: <pre>C:\Documents and Settings\user> cd \tempDir C:\tempDir> svn import . https://host.example.com:8443/repos/</pre>

	--message "Repository Initialization"
3	On your PC, delete the temporary directory structure (tempDir) and all its contents.

Notes

- After the import is finished, the original tree is not converted into a Subversion working copy; you should delete the temporary structure and check out a fresh working copy of the tree
- The process can also be performed using TortoiseSVN's Repository Browser, which provides commands for simply creating new folders directly in the repository

Create a Local Working Copy

In order to use Subversion to provide Version Control of the Packages in a model, you need to prepare a functional SVN working copy folder that can be accessed through an Enterprise Architect Version Control configuration within that model.

Create a Subversion working copy folder

Step	Action
1	Choose or create a suitable directory on your system in which to create your Subversion working copy.
2	Open a command prompt window and navigate to the directory you have selected. For example: <pre>C:\> mkdir mySVNWorkSpace C:\> mkdir mySVNWorkSpace/myEAModelName C:\> cd mySVNWorkSpace/myEAModelName</pre>
3	Perform the initial check out from the Subversion repository, specifying the repository folder and local working copy folder, as well as your user name and password. For example: <pre>C:\> svn checkout</pre>

	<pre>"https://myserver:8443/svn/repos_folder "C:\mySVNWorkspace/myEAModelName" --username myUserName --password myPassword</pre> <p>(By specifying your Subversion username and password, you ensure that they are correctly cached by Subversion and available for use by Enterprise Architect.)</p> <p>If you specify the HTTPS protocol when performing the initial Subversion check out, a prompt displays to accept a security certificate; in this instance, press the P key to permanently accept the certificate.</p> <p>The nominated local folder is configured as a Subversion working copy folder.</p> <p>Any files already existing in the repository folder are downloaded to the working copy folder as working copy files.</p>
4	Verify that your Subversion environment functions correctly.

Notes

- It is important that Subversion caches your username and password, so that it never has to prompt for user input; a check-out operation might not request authentication, and if it does not you should perform an action that does

request authentication, such as adding and committing a dummy test file

- The process can also be performed using TortoiseSVN's Checkout command (which provides options to browse when specifying both your repository folder and your local folder); when prompted for authentication details by TortoiseSVN, make sure you place a check against the 'Save Authentication Data' option

Verify the SVN Workspace

After creating the Subversion local working copy to hold the working copies of your Package files, you can verify that it functions correctly before attempting to use it with Enterprise Architect. You need to be able to add files to Subversion, lock the files and commit changes to those files.

Verify correct operation of a Subversion working copy folder

Step	Action
1	Use Windows to open a command prompt window.
2	Select the directory you specified as the working copy, in the Subversion checkout command when preparing the SVN workspace. For example: <pre>C:\> cd mySVNWorkSpace</pre>
3	Create a test file, such as <i>Test.txt</i> , containing the text <i>Subversion Test</i> . For example: <pre>C:\> echo Subversion Test > Test.txt</pre>
4	Execute each of these Subversion commands: <ul style="list-style-type: none">• <code>svn add Test.txt</code>

- `svn commit -m"Commit comment" Test.txt`
- `svn update Test.txt`
- `svn lock Test.txt`
- Use your preferred editor to modify the file and save the changes
- `svn commit -m"Second commit comment" Test.txt`

The commands should execute without any errors and without prompting the user for any extra input.

Notes

- Your environment must be set up such that you can perform these operations without ever being prompted for user ID or password; for further information, please see the Caching Client Credentials topic in the official Subversion documentation

Subversion Under Wine-Crossover

If you want to set up and use Subversion with Enterprise Architect under Wine, the process is almost identical to the process for setting up and using the systems under Windows. When running Enterprise Architect under Wine or CrossOver, you still use a Windows-based Subversion command line client.

There are some minor differences in the way you prepare the Subversion working environment, specifically in the way you install your Subversion client and the way you check out a working copy folder from the Subversion repository.

System Requirements

Sparx Systems has tested the use of Enterprise Architect with Subversion under Wine 1.2, on macOS 10.4 and 10.6.2, and on Ubuntu 10.04. All tests were passed.

When using Wine 1.2 on the Ubuntu 9.10 platform, Sparx Systems was able to use the svn: and file: protocols to communicate with the SVN server; but not the https: protocol.

Installing a Subversion Client

Wine is able to install applications from either a Windows .exe file, or a .msi installer file.

Place the installer for your Windows Subversion client in a convenient location on the native file system, then open a Wine console window from within Enterprise Architect and run the installer from within the Wine console. Your Subversion installation can then access the same C: drive and folders that Enterprise Architect is accessing.

Preparing a Subversion Environment Under Wine

Under Wine, you can install Subversion from either a Windows .exe file, or a .msi file. By performing your Subversion installation and initial check out from a Wine console window opened from within Enterprise Architect, you have access to the same C: drive and folders that Enterprise Architect is accessing.

Set up Subversion for use with Enterprise Architect, running under Wine

Step	Action
1	Start Enterprise Architect. You do not have to load a project at this point.
2	From the 'Start' ribbon, select 'Appearance > Preferences > Toolbars...' The 'Customize' dialog is opened. Select the 'Tools' tab, then click on the  icon. A new, blank entry is opened on the 'Tools' tab of the 'Customize' dialog.
3	Define the new menu item entry:

	<ul style="list-style-type: none">• In the newly-opened 'Menu contents' field, type the name 'Wine Console'• In the 'Command' field, type 'wineconsole'• In the 'Arguments' field, type 'cmd'• Leave the 'Initial directory' field blank
4	Click on the Close button. The 'Customize' dialog closes.
5	Select the ribbon option: 'Settings > User Tools > Wine Console'. A Wine console window opens.
6	Type 'C:' and press the Enter key. The Wine console switches to the C: drive.
7	Issue the command to install your Subversion client. For example: <pre>C:\>/Installers/Subversion-client-1.9.5.win32.exe</pre> To install from a .msi file, use Wine's msiexec utility. For example: <pre>C:\>msiexec /i "Installers\Slik-Subversion-1.9.7-win32.msi"</pre> Installation of the Subversion command line client begins.
8	Create a folder to serve as the working copy folder to

	<p>be used by Enterprise Architect. For example:</p> <pre>C:\>mkdir C:\VC_workspaces\SVN_workcopy</pre>
9	<p>Issue the command to perform the initial checkout from the Subversion repository, specifying the repository folder, working copy folder, username and password. For example:</p> <pre>C:\>svn checkout "https://myServer:8443/svn/repos_folder" "C:\VC_workspaces\SVN_workcopy " --username myUserName --password myPassword</pre> <p>(After you specify your Subversion username and password, they are correctly cached by Subversion and are available for use by Enterprise Architect.)</p> <p>If the HTTPS protocol is specified when performing the initial Subversion check out, you are prompted to accept a security certificate; in this instance, press the P key to permanently accept the certificate.</p> <p>The nominated local folder is configured as a Subversion working copy folder. Any files already existing in the repository folder are downloaded to the working copy folder as working copy files.</p>
10	<p>Type 'Exit' and press the Enter key.</p> <p>The Wine console window closes.</p> <p>You are now ready to load a project in Enterprise Architect and apply Version Control to it, using the</p>

normal Windows-based procedures.

Notes

- You should copy the installer for your Windows Subversion client to a convenient location on the native file system, so that you can easily refer to it from within the Wine console window in step 7

TortoiseSVN

TortoiseSVN is a Windows shell extension for Subversion; it provides icon overlays in Windows Explorer that are useful as a tool for observing the status of your Subversion controlled files. You can also use it to create your repository sub-trees and check out local working copies from within Windows Explorer, using simple menu commands.

You can download TortoiseSVN from <http://tortoisesvn.net/downloads.html>.

Notes

- Enterprise Architect can only communicate with the Subversion server using the Subversion command line client `svn.exe`

Create a TFS Environment

You can use Microsoft Team Foundation Server (TFS) as a Version Control provider for Enterprise Architect. The first step in doing this is for a TFS administrator to install and configure the TFS server and client applications. A number of basic tasks are performed in creating an operational TFS environment.

Tasks in Creating a TFS Environment

Task	Detail
Obtain and install TFS	<p>Enterprise Architect uses the TFS command line client to integrate TFS Version Control.</p> <p>The TFS command line client is normally available as part of your Visual Studio installation.</p>
Choose a TFS project	<p>It is good practice to create a new TFS project, or least a new Source Control Folder within a project, for each Enterprise Architect project being added to Version Control with TFS.</p> <p>If you have a single Enterprise Architect project that contains many different models (for example, a DBMS hosted</p>

	<p>project with multiple model root nodes), you might choose to create a new TFS project for each separate model.</p> <p>For further information, please consult your TFS product documentation.</p>
<p>Create a TFS workspace</p>	<p>A working copy folder must exist on each users' machine, for Enterprise Architect to use when exporting and importing the Version Controlled Package files. It is this folder that is specified as the Local Project Path, when defining your Version Control Configurations.</p> <p>The working copy folder is the 'sandbox' where you modify the controlled files. The working copy folder is usually associated with a folder that exists within the Version Control repository. In TFS, the TFS workspace is used to map a local working folder on your PC to a Source Control Folder within a TFS project.</p> <p>TFS 2012 and VS 2012 (and later versions) feature a new type of workspace called 'local' workspaces. Do not attempt to use TFS 'local' workspaces with Enterprise Architect. You must use only 'server' workspaces for Enterprise Architect Version Control, as 'local' workspaces do not support the</p>

	<p>application of checkout locks to files. Enterprise Architect relies on the presence of checkout locks to ensure that Packages can only be checked out exclusively and that a given Package is not already checked-out in some other project (for instance, in a Private Model deployment). This is necessary because it is not practical to merge the XMI Package files that Enterprise Architect uses for Version Control.</p> <p>A single TFS workspace can map many different local folders, each one to a separate Source Control Folder. In this case, TFS can take a long time to work through and update the files in all of those folders, and the system might appear to 'freeze' whilst it waits for TFS to hand back program control.</p> <p>You can avoid this if you keep your Version Controlled Package files in a folder that is separate from other Artifacts, such as source code files, creating a separate work space to use just for your Package files, or creating and mapping a separate folder for Package files within an existing workspace.</p>
<p>Configure</p>	<p>The XMI format files used for the</p>

exclusive check-outs	Version Control of Enterprise Architect's Packages can not be merged as if they were ordinary text files. Therefore, Enterprise Architect must enforce serialized editing of its Version Controlled Packages. As a consequence, it is important that TFS is configured to use 'exclusive checkouts' for XML files.
Verify the TFS Workspace	Enterprise Architect uses the TFS command line client to checkin and checkout files from the TFS repository. After creating the TFS workspace, it is important to verify that the command line client can be used to add, check-in and check-out files residing in the working copy folder that is mapped through this workspace.

Notes

- TFS can also be used with an SCC client; the MS TFS-SCC client is available for download from Microsoft's web site
- MDG Integration for Visual Studio 2005 or 2008 enhances TFS support by providing access to, for example, work items and bugs within both Enterprise Architect and the MDG Integration product

TFS Workspaces

In order to use TFS to provide Version Control of the Packages in a model, you prepare a functional TFS workspace that can be accessed through an Enterprise Architect Version Control configuration within that model. You use the TFS workspace to map a local working folder on your PC to a Source Control Folder within a TFS project repository.

It is assumed that have TFS 2013 open and a TFS Team Project already exists for you to use in Version Control of the Packages of your Enterprise Architect project. You can create the TFS workspace through MS Visual Studio.

TFS 2013 and later versions support the use of Local workspaces. However, Local workspaces do not support the application of checkout locks. For this reason, Sparx Systems strongly advises against the use of Local workspaces when Version Controlling your Enterprise Architect Package files. Using Local workspaces carries a high risk of merge conflicts when checking in, which would almost certainly result in loss of data or a corrupted model database.

Map a local folder to a TFS Source Control Folder

Step	Action

1	<p>Connect to your TFS server.</p> <p>From the TFS main menu, choose 'View Team Explorer'.</p> <p>In the Team Explorer toolbar, click on the Connect to Team Projects button (fourth from left, with a power plug icon).</p> <p>The 'Team Explorer Connect' page displays.</p>
2	<p>Click on the link 'Select Team Projects...'</p> <p>The 'Connect to Team Foundation Server' dialog displays.</p>
3	<p>Click on the appropriate Team Foundation Server, Team Project Collection and Team Project, then click on the Connect button.</p>
4	<p>Click on the Home page of the Team Explorer, and then on the Source Control Explorer button.</p> <p>The Source Control Explorer view displays.</p>
5	<p>In the Source Control Explorer, click on the drop-down arrow in the 'Workspace' field in the toolbar, then click on 'Workspaces' at the bottom of the list.</p> <p>The 'Manage Workspaces' dialog displays.</p>
6	<p>Click on the Add button.</p>

	The 'Add Workspace' dialog displays.
7	Click on the Advanced button. A number of new fields display on the dialog.
8	Type in an appropriate name for the new workspace and, if required, type in a comment.
9	Set the 'Location' field to 'Server'. This setting is important. This setting is not available in TFS 2010 and earlier releases, where all workspaces are Server based.
10	Click in the Source Control Folder column, then click on the Browse button to select a Source Control Folder. Select the Source Control folder (in the Team Project) to use for controlling Enterprise Architect Packages.
11	Click on the Browse button in the 'Local Folder' column and create a new local folder. This is the working copy folder into which Enterprise Architect exports the Package files.
12	Click on the OK button. The new workspace is created and saved. The 'Add Workspace' dialog closes.

- | | |
|----|---|
| 13 | Click on the OK button.
The 'Manage Workspaces' dialog closes. |
|----|---|

Notes

- The local folder referenced in step 11 is the Working Copy Path that should be specified when defining an Enterprise Architect Version Control Configuration to use this TFS workspace

TFS Exclusive Check Outs

The XMI format files used for the Version Control of Enterprise Architect's Packages can not be merged as ordinary text files can. Therefore Enterprise Architect must enforce serialized editing of its Version Controlled Packages, and it is important that Team Foundation Server is configured to use 'exclusive checkouts' for XML files. Otherwise, TFS can return file statuses that make it look as if the Package file is not checked-out by another user when indeed it is.

You set exclusive checkouts in the TFS workspace through MS Visual Studio.

Configure TFS to enforce exclusive check outs for XML files

Step	Action
1	Using Visual Studio, from the main menu select 'View Team Explorer'.
2	In the 'Team Explorer' pane, right-click on the TFS Server name that is controlling the Enterprise Architect Package files, then from the context menu select 'Team Foundation Server Settings Source Control File Types'.

3	Select the entry for XML files (or create an entry if necessary) then click on the Edit button.
4	Deselect the 'Enable file merging and multiple check out' checkbox.

Verify the TFS Workspace

Enterprise Architect will be using the TFS command line client to commit file updates from the local working copy folder into the TFS repository. After creating the TFS workspace that maps your local working copy folder to a TFS repository folder, it is good practice to verify that the TFS workspace functions correctly before attempting to use it with Enterprise Architect. You need to be able to add files to TFS, place a check-out lock on the files and check-in changes to those files.

Verify correct operation of a TFS Workspace

Step	Action
1	Use Windows to open a command prompt window.
2	Select the directory you specified as the local working copy folder when creating the TFS workspace. For example: <pre>C:\> cd myTFSWorkingCopyFolder</pre>
3	Create a test file, such as <i>Test.xml</i> , containing the text ' <i>my TFS Test</i> '. For example: <pre>C:\> echo my TFS Test > Test.xml</pre>

	(The filename extension '.xml' is used because the TFS server should have been configured to allow exclusive checkouts for XML files.)
4	<p>Using the command line client, execute each of these TFS commands:</p> <ul style="list-style-type: none">• <code>tf.exe add Test.xml</code>• <code>tf.exe checkin Test.xml /override:"Manual check in." /comment:"a message"</code>• <code>tf.exe checkout /lock:checkout Test.xml</code> <p>Use your preferred editor to modify the file and save the changes.</p> <ul style="list-style-type: none">• <code>tf.exe checkin Test.xml /override:"Manual check in." /comment:"a message"</code>• <code>tf.exe get . /recursive</code>

Notes

- All of the commands in step 4 should execute without any errors; in particular, you should be able to apply a checkout lock when checking out the file
- If the checkout command reports any errors, you might have to reconfigure the TFS workspace as a server based workspace, or you might have to configure the TFS Server to use 'exclusive checkouts' for XML files

Create a CVS Environment

You can use Concurrent Versions System (CVS) as a Version Control provider for Enterprise Architect. The first step in doing this is for a CVS administrator to install and configure the appropriate software. A number of basic tasks are performed in creating an operational CVS environment, and useful tools are available for performing some of these tasks.

Tasks in Creating a CVS Environment

Task	Detail
Install server components	Executable files for CVS can be obtained from March Hare Software. CVS server components are available to run on a wide range of different hardware and operating systems; Enterprise Architect is not affected by your choice of server components.
Create a repository	Please consult the official CVS documentation.
Create CVS users	Please consult the official CVS documentation.

<p>Create a new repository module</p>	<p>It is recommended good practice to create a new repository module in CVS for each new Enterprise Architect model being added to Version Control with CVS. Users should create a new local working copy folder from the module to be used with that model.</p> <p>A repository module represents a project, or a set of related files in the repository. TortoiseCVS can greatly simplify the process of creating new repository sub-trees.</p>
<p>Install client components</p>	<p>Executable files for CVS can be obtained from March Hare Software.</p> <p>Enterprise Architect is a Windows based application - it requires a Windows based CVS command line client for integration.</p>
<p>Create a working copy folder</p>	<p>A working copy folder must exist on each users' machine, for Enterprise Architect to use when exporting and importing the Version Controlled Package files. It is this folder that is specified as the Local Project Path, when defining your Version Control Configurations.</p> <p>The working copy folder is the 'sandbox' where you modify the controlled files. The working copy folder is usually</p>

	<p>associated with a folder that exists within the Version Control repository. In CVS, to create a local working copy you perform an initial check-out of a folder from the CVS repository; this downloads a copy of the folder and its contents, to create your local working copy.</p> <p>TortoiseCVS can greatly simplify the initial check out of a working copy folder.</p>
<p>Setting up CVS under Wine/CrossOver</p>	<p>The process of setting up and using CVS with Enterprise Architect under Wine is almost identical to the process when running natively under Windows, apart from minor differences in installing the CVS client and performing the initial checkout of the working copy folder.</p>

Notes

- If you do not already use CVS for Version Control, you should consider using Subversion instead; Subversion's client-server protocols provide a broader range of possibilities for connecting to remote servers, with easier set up of secure connections
- TortoiseCVS is a Windows shell extension; Enterprise Architect cannot use TortoiseCVS as its client, it must use

the CVS command line client

Prepare a CVS Local Workspace

In order to use CVS to provide Version Control of the Packages in a model, you need to prepare a functional CVS working copy folder that can be accessed through an Enterprise Architect Version Control configuration within that model.

Prepare a CVS Working Copy Folder

Step	Action
1	<p>Ask your System Administrator to install CVS and create a remote repository, with a module that you can use to control your Enterprise Architect Package files.</p> <p>Your administrator must create a username and password for you before you can make a connection.</p>
2	<p>Select or create a suitable directory to use as your CVS working copy directory.</p>
3	<p>Open a command prompt window and navigate to your CVS working copy directory. For example:</p> <pre>C:\> mkdir myCVSWorkSpace C:\> cd myCVSWorkSpace</pre>

4	<p>Log in to the remote CVS repository. For example:</p> <pre>C:\myCVSWorkspace> cvs -d:pserver:myUserID@ServerName:/reposPath login</pre> <p>Replace <i>myUserID</i> with your CVS username, replace <i>ServerName</i> with the name of your CVS server and replace <i>reposPath</i> with the path to the repository on the server.</p> <p>A prompt for a password displays.</p>
5	<p>Enter your password.</p> <p>You are logged in to the CVS server.</p>
6	<p>Perform the initial checkout of the CVS repository module, into the local working copy directory. For example:</p> <pre>C:\myCVSWorkspace> cvs -d:pserver:myUserID@ServerName:/reposPath checkout moduleName</pre> <p>(Replace <i>moduleName</i> with the name of the repository module that you want to check out.)</p> <p>A subdirectory is created in your current working directory, with the same name as the module being checked out.</p> <p>Any files already existing in the repository module are downloaded to the working copy folder as working copy files.</p>
7	<p>Verify that your CVS environment functions</p>

	correctly.
--	------------

Notes

- Much of the process can also be performed (more simply) using the TortoiseCVS command 'Make New Module'

Verify the CVS Workspace

After creating the CVS local working copy to hold the working copies of your Package files, you can verify that it functions correctly before attempting to use it with Enterprise Architect. You need to be able to add files to CVS, and commit changes to those files. You also need to be able to register as an editor of the file and retrieve the list of currently registered editors.

Verify correct operation of a CVS working copy folder

Step	Action
1	Use Windows to open a command prompt window.
2	Select the directory you specified as the working copy in the cvs checkout command, when preparing the CVS workspace. For example: <pre>C:\> cd myCVSWorkSpace</pre>
3	Create a test file, such as <i>Test.txt</i> , containing the text <i>CVS Test</i> . For example: <pre>C:\> echo CVS Test > Test.txt</pre>

4	<p>Execute these CVS commands:</p> <ul style="list-style-type: none">• <code>cv</code>s add Test.txt• <code>cv</code>s commit -m"Commit comment" Test.txt• <code>cv</code>s update Test.txt• <code>cv</code>s edit Test.txt• <code>cv</code>s editors Test.txt <p>The commands should execute without any errors and without prompting the user for any extra input. The editors command should produce output that resembles this:</p> <pre>Test1.txt myUserID Tue Aug 9 10:08:43 2009 GMT myComputer C:\myCVSWorkspace\moduleName</pre>
5	<p>Take note of the userID that follows the filename. Enterprise Architect must find and use this user ID when you create your Version Control configuration.</p>

Notes

- Your environment must be set up such that you can perform these operations without ever being prompted for input, such as user ID or password

TortoiseCVS

TortoiseCVS is a Windows shell extension for CVS; it provides icon overlays in Windows Explorer that are useful as a tool for observing the status of your CVS controlled files. You can also use it to create your repository modules and check out local working copies from within Windows Explorer using simple menu commands.

You can download TortoiseCVS from:

<http://www.tortoise cvs.org>.

Notes

- Enterprise Architect must use the CVS command line client to communicate with the CVS server; it cannot use TortoiseCVS

Create an SCC Environment

You can use a Microsoft Common Source Code Control (SCC) compatible product as a Version Control provider for Enterprise Architect. The first step in doing this is for an administrator to install and configure the server and client applications. A number of basic tasks are performed in creating an operational SCC-based environment.

Tasks in Creating an SCC Environment

Task	Detail
Install and configure your chosen Version Control product	<p>A Version Control server component is typically installed on a dedicated server machine. All Enterprise Architect users who require access to Version Control must be able to connect to the server machine.</p> <p>After installing the Version Control software, the administrator should also create Version Control user IDs for all users who require access to Version Control.</p> <p>For further information, consult the product documentation for your particular Version Control product.</p>

<p>Create a new SCC project</p>	<p>It is good practice to create a new SCC Version Control project, or least a new folder within a project, for each Enterprise Architect project being added to Version Control with SCC.</p> <p>If you have a single Enterprise Architect project that contains many different models (for example, a DBMS hosted project with multiple model root nodes), you might choose to create a new SCC Version Control project for each separate model.</p> <p>For further information, consult the product documentation for your particular Version Control product.</p>
<p>Configure your SCC project to support exclusive check-outs for .XML files</p>	<p>The XMI-format files used for the Version Control of Enterprise Architect Packages can not be merged in the same way as ordinary text files can. Therefore, Enterprise Architect must enforce serialized editing of its Version Controlled Packages. As a consequence, it is important that your Version Control application is configured to use 'exclusive checkouts' for XML files.</p>
<p>Create a local working copy</p>	<p>A working copy folder must exist on each users' machine, for Enterprise Architect</p>

folder	<p>to use when exporting and importing the Version Controlled Package files. It is this folder that is specified as the Local Project Path, when defining your Version Control Configurations.</p> <p>The working copy folder is the 'sandbox' where you modify the controlled files. The working copy folder is usually associated with a folder that exists within the Version Control repository. Your Version Control product provides some means by which you associate a working copy folder with a repository folder. For further information, consult the documentation for your particular Version Control product.</p>
--------	--

Notes

- When installing the client component software on users' PCs, check that the SCC client is also installed, as it might not be a part of the default installation

Upgrade at Enterprise Architect Version 4.5, Under SCC Version Control

If you are working in Enterprise Architect release 4.5 or later and you open an SCC Version Controlled project that was created under a release earlier than 4.5, you must identify the SCC connection with a new unique ID. You can assign a name to the existing SCC configuration or associate the project with another configuration that has previously been assigned a unique ID.

By having a unique ID for each Version Control configuration, you can assign a configuration quickly and efficiently using configurations that have been created previously for other Version Controlled repositories. This enables you to configure the many Packages to use an existing Version Control repository; this can apply to Packages created for more than just one model enabling a great deal of flexibility.

Upgrade an existing SCC Version Controlled project created before release 4.5, in Enterprise Architect release 4.5 or later

Step	Action
1	Open the project that has an SCC Version Control

	<p>configuration created in Enterprise Architect earlier than version 4.5.</p> <p>The 'Select or Create Unique ID for Version Control' dialog automatically displays.</p>
2	<p>On the dialog, either create an ID for an existing configuration or choose a previously created one from the 'Unique ID' drop-down list.</p>
3	<p>The existing SCC configuration is the initial value, represented by SCC-XXXXX; this number is not especially meaningful, therefore it is recommended that the configuration be given a meaningful name.</p>
4	<p>You can associate the Version Controlled Package with a previously-defined configuration by selecting an existing configuration from the 'Unique ID' drop-down list (if one exists).</p>
5	<p>After you have assigned the unique ID, click on the OK button to load the model.</p>

Version Control Configuration

Once you or an Administrator have installed and configured the Version Control product software, to start using Version Control you must first define a Version Control configuration within your project in Enterprise Architect, to be used to control the Packages in the project. You can define any number of Version Control configurations in a single model, but any given Package is associated with only one configuration. Typically, a single Version Control configuration is used to control all of the packages within a model.

Access

Ribbon	Settings > Version Control > Project-VC
Context Menu	Right-click on Package > Package Control > Version Control Settings

Define Version Control Configuration

Step	Action

1	On the 'Version Control Settings' dialog, click on the New button.
2	In the 'Unique ID' field, type a suitable configuration name.
3	Select the Type of Version Control product you are connecting to, by clicking on the corresponding radio button.
4	<p>At this point, the middle section of the dialog changes to display a collection of fields specific to the type of Version Control configuration you are defining.</p> <p>Enter details relating to the Version Control workspace that this configuration is to use.</p>
5	Click on the Save button. The new configuration is added to the Defined Configurations list.
6	<p>If you want to create another Version Control configuration, return to step 1.</p> <p>When you have finished defining your Version Control configurations, click on the Close button.</p>

Notes

- Version Control Configuration details are stored in the user's Windows Registry settings, but each project stores a list of the configurations it uses, so that Version Control connections can be initialized as the project is being loaded
- If you are using the Corporate or extended editions of Enterprise Architect with security enabled, the administrator must also set up access permissions to configure and use Version Control

Version Control Settings

Defining Version Control settings within Enterprise Architect should only be performed after you have successfully created the Version Control environment that you intend to use to control your Package files. If you have not yet done so, please refer to the Help topic *Applying Version Control in a Team Environment* for a summary of what is required.

To set up a Version Control configuration on your model, or update an existing Version Control configuration, you define a number of settings that control how the status of your model is communicated to your Version Control system. You define these settings using the 'Version Control Settings' dialog.

Access

Ribbon	Settings > Version Control > Project-VC
Context Menu	Right-click on Package > Package Control > Version Control Settings

Configuration Options

Option	Action
This model is private	<p>Select to specify that this model database is to be accessed by just a single user (Private Model).</p> <p>Leave unselected (the default) or deselect to specify that the database is to be accessed by multiple concurrent users (Shared Model).</p> <p>If in doubt, use the default setting.</p>
Save nested Version Controlled Packages to stubs only	<p>Select to specify that the exported XMI file for a Version Controlled Package will contain Package stubs (place holders) for nested Version Controlled child Packages (recommended).</p> <p>Deselect to specify that the exported XMI file will contain the full content of nested Version Controlled child Packages.</p>
For all Packages, create placeholders for external references	<p>Select to force all XMI 1.1 imports across the model to exclude incoming relationships and instead create external references.</p> <p>If the 'Create placeholders for missing External References during XMI 1.1/2.1 and Native File Import' checkbox is not selected in the XML Specifications options for a user, this field overrides that</p>

	<p>setting.</p> <p>The <i>XML Specifications</i> Help topic provides an example of the benefits of selecting this option.</p>
Unique ID	<p>Specify a name that uniquely identifies the configuration. Either:</p> <ul style="list-style-type: none"> • Type a name to identify a new configuration, or • Click on the drop-down arrow and select the name of a configuration previously defined in a different project (if any exist)
Type	<p>Click on the appropriate radio button for the type of Version Control system you are associating with this configuration.</p> <p>The middle section of the dialog changes to display a collection of fields relating to the type of Version Control configuration you are defining.</p> <p>Set the type to SCC for:</p> <ul style="list-style-type: none"> • MS Visual Source Safe • Rational Clear Case • Perforce • AccuRev • Any other SCC-compatible clients <p>For any other product that you are using,</p>

	select the type that matches the product - CVS, Subversion or TFS.
New	Click on this button to clear the fields and create a new Version Control configuration.
Save	Click on this button to save the details of a new or updated configuration.
Delete	Click on an entry in the Defined Configurations list and click this button to remove the definition of the selected configuration from this model.
Defined Configurations	Review a list of configurations that are in use in the current model.
In future, do not prompt for incomplete configurations	Select to specify that the user is not prompted to complete the definition of configurations that are not fully specified (the default). Deselect to prompt the user to complete configurations that are not fully defined.
Close	Close the 'Version Control Settings' dialog.

Help	Display this Help topic.
------	--------------------------

Notes

- It is important that, for any given Version Controlled Package file, any user accessing that file from any model uses Version Control configurations having the same Unique ID
- When you first open a model that was created by another user and that uses Version Control, the Version Control configuration(s) used by that model do not yet exist in your Windows registry settings; you have to complete the definitions of those configurations before you can use Version Control in that project
- If User Security is enabled, you must have 'Configure Version Control' permission to set up Version Control options for the current model
- It is possible to use multiple Version Control configurations in the same model

SCC Settings

When you are setting up your Version Control configurations on the 'Version Control Settings' dialog, and you set the configuration type to 'SCC', the dialog presents a set of fields specific to SCC-based configurations. You can then define details such as:

- The working copy folder to be used with the configuration
- The details necessary to connect to the SCC Version Control system

You set the Version Control configuration type to SCC for version Control providers such as:

- MS Visual Source Safe
- Rational Clear Case
- Perforce
- AccuRev
- Any other SCC-compatible clients

Access

Ribbon	Settings > Version Control > Project-VC : Type: SCC
Context Menu	Right-click on Package > Package Control > Version Control Settings: Type: SCC

Settings

Option	Action
Local Project Path	<p>Displays the full path of the folder that contains the local (working) copies of the XMI Package files.</p> <p>This field is read-only; its value can only be set through use of the Select Path button.</p>
Select Path	<p>Click on this button to choose the Local Project Path, by opening a file browser dialog and navigating through the file system to the appropriate folder.</p> <ul style="list-style-type: none">• After you choose the appropriate folder path, the 'Select SCC Provider' dialog displays, listing all SCC providers that are installed on the current workstation; choose the SCC provider to use and click on the OK button• At this point, the SCC client opens its own dialog to prompt you for information; SCC products implement this functionality in varied ways, but typically you are prompted to log in to

	<p>the Version Control system, then prompted to choose the SCC project to use and possibly a (server) folder contained within that project</p> <ul style="list-style-type: none"> • At the conclusion of this process, all of the SCC details should be filled in; you can then save the definition by clicking on the Save button on the 'Version Control Settings' dialog
Current User	<p>Displays the user name used to log on to the Version Control system that is accessed through this configuration. This field is read-only; the value it displays is retrieved from the SCC client.</p>
SCC Provider	<p>Displays the name of the SCC provider. This field is read-only; the value it displays is retrieved from the SCC client.</p>
SCC Project	<p>Displays the name of the SCC Project that this configuration attaches to. This field is read-only; the value it displays is retrieved from the SCC client.</p>

Notes

- You define the SCC-specific details as part of the broader process of setting up a Version Control Configuration on the 'Version Control Settings' dialog

CVS Settings

When you are setting up your Version Control configurations on the 'Version Control Settings' dialog, and you set the configuration type to CVS, the dialog presents a set of fields specific to CVS-based configurations. You can then define details such as:

- The working copy folder to be used with the configuration
- The path to the CVS command line client

Access

Ribbon	Settings > Version Control > Project-VC : Type: CVS
Context Menu	Right-click on Package > Package Control > Version Control Settings: Type: CVS

Settings

Option	Action
Working Copy Path	Displays the full path of the folder that contains the local (working) copies of the

	<p>XMI Package files.</p> <p>This field is read-only; its value can only be set through use of the Select Path button.</p>
Select Path	<p>Click on this button to choose the working copy path, by opening a file browser dialog and navigating through the file system to the appropriate folder.</p>
Current User	<p>This field is read-only; its value is retrieved from a file named CVS\Root, located in the folder selected using the Select Path button.</p>
CVS Exe Path	<p>Displays the full path of the CVS command line client executable file.</p> <p>This field is read-only; its value can only be set through use of the Select Path button.</p>
Select Path	<p>Click on this button to specify the path to the CVS command line client, by opening a file browser dialog and navigating through the file system to locate the appropriate file.</p>
VC Time-Out	<p>Specify the amount of time that Enterprise Architect waits for a CVS</p>

Value	<p>command to complete; if the command does not complete within the allowed time, the system displays a Time-out error message, detailing the command that failed to complete.</p> <p>This single time-out value is applied to all Version Control Configurations (of types SVN, TFS and CVS) that the user accesses from this workstation.</p>
-------	---

Notes

- When connecting to a remote CVS repository, the 'Current User' field should display the user name used to log into that repository; if this does not happen, it indicates that Enterprise Architect cannot extract the user name from the file ...\`WorkingCopyPath\CVS\Root` and the configuration does not work correctly
- You define the CVS-specific details as part of the broader process of setting up a Version Control configuration on the 'Version Control Settings' dialog

SVN Settings

When you are setting up your Version Control configurations on the 'Version Control Settings' dialog, and you set the configuration type to 'Subversion', the dialog presents a set of fields specific to Subversion-based configurations. You can then define details such as:

- The working copy folder to be used with the configuration
- The path to the Subversion command line client

Access

Ribbon	Settings > Version Control > Project-VC : Type: Subversion
Context Menu	Right-click on Package > Package Control > Version Control Settings: Type: Subversion

Settings

Option	Action
Working Copy Path	Displays the full path of the folder that contains the local (working) copies of the

	<p>XMI Package files.</p> <p>This field is read-only; its value can only be set through use of the Select Path button.</p>
Select Path	<p>Click on this button to choose the Working Copy Path, by opening a file browser dialog and navigating through the file system to the appropriate folder.</p>
Subversion Exe Path	<p>Displays the full path of the Subversion command line client executable file.</p> <p>This field is read-only; its value can only be set through use of the associated Select Path button.</p>
Select Path	<p>Click on this button to specify the path to the Subversion command line client, by opening a file browser dialog and navigating through the file system to locate the appropriate file.</p>
VC Time-Out Value	<p>Specify the amount of time that Enterprise Architect should wait for a Subversion command to complete; if the command does not complete within the allowed time, the system displays a Time-out error message, detailing the command that failed to complete.</p>

	<p>This single time-out value is applied to all Version Control Configurations (of types SVN, TFS and CVS) that the user accesses from this workstation.</p>
--	--

Notes

- You define the Subversion-specific details as part of the broader process of setting up a Version Control configuration on the 'Version Control Settings' dialog

TFS Settings

When you are setting up your Version Control configurations on the 'Version Control Settings' dialog, and you set the configuration type to 'TFS', the dialog presents a set of fields specific to TFS-based configurations. You can then define details such as:

- The working copy folder to be used with the configuration
- The user name and password to log in to the TFS server
- The path to the TFS command line client

Access

Ribbon	Settings > Version Control > Project-VC: Type: TFS
Context Menu	Right-click on Package > Package Control > Version Control Settings: Type: TFS

Settings

Option	Action
Working	Displays the full path of the folder that

Copy Path	<p>contains the local (working) copies of the XMI Package files.</p> <p>This field is read-only; its value can only be set through use of the associated Select Path button.</p>
Select Path	<p>Click on this button to choose the Working Copy Path. The file browser dialog opens, through which you navigate through the file system to the appropriate folder.</p>
Server Name	<p>Displays the name of the TFS Server that is associated with the working copy folder specified in the 'Working Copy Path' field.</p> <p>This field is read-only; Enterprise Architect retrieves the value it displays by querying the TFS client.</p>
Workspace Name	<p>Displays the name of the TFS Workspace that is associated with the working copy folder specified in the 'Working Copy Path' field.</p> <p>This field is read-only; Enterprise Architect retrieves the value it displays by querying the TFS client.</p>
User Name	<p>Type in the user name with which to log</p>

	into the TFS Server.
Password	Type in the password with which to log into the TFS Server.
Display Name	<p>TFS 2013 and later releases use a Display Name to report on who owns a checkout lock on a file. TFS 2010 uses AccountID when reporting lock owners and so does not require a Display Name.</p> <p>If using TFS 2013, type in your TFS Display Name as shown in the User column of the Visual Studio Source Control Explorer when you checkout a file.</p>
Checkout Locks Required	<p>This checkbox defaults to selected.</p> <p>TFS 2013 supports the use of Local workspaces, but these do not support checkout locks. If you want to use TFS Local workspaces (not recommended), you must deselect this checkbox.</p> <p>Otherwise, leave the checkbox selected.</p> <p>It is recommended that all workspaces used for Version Controlling Enterprise Architect Package files are set as 'Server' workspaces.</p>
TFS Exe Path	Displays the full path of the TFS

	<p>command line client executable file.</p> <p>This field is read-only; its value can only be set through use of the associated Select Path button.</p>
Select Path	<p>Click on this button to specify the path to the TFS command line client.</p> <p>The file browser dialog opens, through which you navigate through the file system to the appropriate folder.</p>
VC Time-Out Value	<p>Type in the number of seconds that Enterprise Architect should wait for a TFS command to complete; if a command does not complete within this allowed time, the system displays a Time-out error message, detailing the command that failed to complete.</p> <p>This single time-out value is applied to all Version Control configurations (of types SVN, TFS and CVS) that the user accesses from this workstation.</p>

Notes

- If you automatically log in to TFS through a path external to Enterprise Architect (for example, through MS

Integrated Security), you can leave the 'User Name' and 'Password' fields blank

- If the 'Password' field is blank, Enterprise Architect retrieves your Windows username and uses that value when determining whether a Package file is checked out to you or to another user
- TFS Version Control can also be accessed using the TFS MSSCCI client; to make use of the TFS MSSCCI client, please define an SCC based Version Control configuration
- You define the TFS-specific details as part of the broader process of setting up a Version Control configuration on the 'Version Control Settings' dialog

Re-use an Existing Configuration

Once a Version Control configuration has been defined for use in one project, it is possible to re-use that configuration in other projects to provide access to:

- An already existing Version Control environment (a working copy directory and its associated repository that is already in use)
- Version Controlled Packages that were created (and Version Controlled) in another project

Access

Ribbon	Settings > Version Control > Project-VC
Context Menu	Browser window right-click on Package Package Control Version Control Settings

Select existing configuration

Step	Action
1	On the 'Version Control Settings' dialog, click on the

	<p>New button.</p> <p>The various fields on the dialog are cleared, ready for data entry.</p>
2	<p>In the 'Unique ID' field, click on the drop-down arrow and select one of the previously-defined Version Control configurations.</p> <p>The details of the selected configuration are displayed in the dialog.</p>
3	<p>Click on the Save button.</p> <p>The configuration details are saved and are ready for use in the current project.</p>

Applying to Packages

Version Control in Enterprise Architect operates at a Package level. Any Package in the repository can be put under Version Control and assigned to any Version Control Configuration. This means that different Packages can be controlled by different Version Control systems. However, in typical usage, all packages in a model will be controlled by just one Version Control configuration.

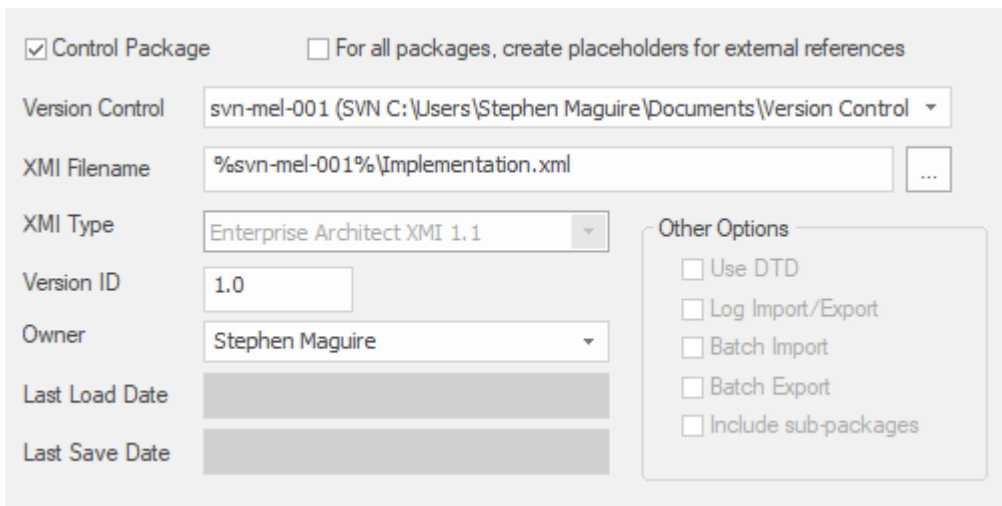

The screenshot shows the 'Package Control Options' dialog box. It features a 'Control Package' checkbox which is checked, and an unchecked checkbox for 'For all packages, create placeholders for external references'. The 'Version Control' dropdown is set to 'svn-mel-001 (SVN C:\Users\Stephen Maguire\Documents\Version Control)'. The 'XMI Filename' is '%svn-mel-001%\Implementation.xml'. The 'XMI Type' is 'Enterprise Architect XMI 1.1'. The 'Version ID' is '1.0'. The 'Owner' is 'Stephen Maguire'. There are fields for 'Last Load Date' and 'Last Save Date'. An 'Other Options' section contains five unchecked checkboxes: 'Use DTD', 'Log Import/Export', 'Batch Import', 'Batch Export', and 'Include sub-packages'.

The Package Control Options window showing the setting for the selected Package.

Configure Controlled Package

Once your Version Control application is set up and you have Version Control configurations in place, you can place the individual Packages in your model under Version Control. To put a Package under Version Control, you:

- Flag the Package as a controlled Package
- Specify the Version Control configuration to control it and
- Associate an XMI file with the Package

You can then export and import the Package data to and from the file and issue commands to the Version Control system.

Access

Ribbon	Settings > Version Control > Package-VC
Keyboard Shortcuts	Ctrl+Alt+P

Apply Version Control to a single Package

Step	Action
1	Click on the 'Control Package' checkbox to select it, indicating that this Package is to be controlled.
2	Click on the 'Version Control' drop-down arrow and select the Version Control configuration to be used to control this Package.
3	<p>The 'XMI Filename' field displays a default filename for the Package export file, based on the Package name.</p> <p>Optionally, modify the filename. Either:</p> <ul style="list-style-type: none">• Type a new name, or• Click on the  button to open a file selection dialog <p>The target file must be located within the working copy folder of the selected Version Control configuration, or one of its sub-folders.</p>
4	<p>The 'Version ID' field defaults to '1.0'.</p> <p>Optionally, change this to a different version number.</p>
5	<p>The 'Owner' field defaults to your user name.</p> <p>Optionally, type or select the name of the user who actually owns the Package.</p>

6	<p>Click on the OK button.</p> <p>The 'Add Package to Version Control' dialog displays.</p>
7	<p>Optionally, clear the 'Keep checked out' checkbox.</p> <p>After applying Version Control, the Package either remains checked-out for editing, or is checked-in and locked against editing, depending on this setting.</p>
8	<p>Click on the OK button.</p> <p>The 'Add Comment' dialog displays.</p>
9	<p>Optionally, add any further comments to the default comment.</p> <p>Enterprise Architect provides a default comment that includes the current date & time.</p>
10	<p>Click on the OK button.</p> <p>The current Package is exported to the nominated XMI file, which is then committed to Version Control. The Package icon in the Browser window is updated to reflect the Package's Version Control status.</p>





Notes

- If you are using the Corporate or extended editions of Enterprise Architect with security enabled, these features are only available to users who have been granted permission to configure and use Version Control

Browser Window Indicators

Packages under Version Control are identified in the Browser window by icons that indicate the current status of the Package.

Indicators

Icon	Indicates that
	<p>This Package is Version Controlled and not checked out to you.</p> <p>You cannot edit the Package (until you check out the Package yourself).</p>
	<p>This Package is Version Controlled and checked out to you.</p> <p>You can edit the Package.</p>
	<p>This Package is Version Controlled, but you checked it out whilst not connected to the Version Control server.</p> <p>You can edit the Package but there could be version conflicts when you check the Package in again.</p>
	<p>This Package is controlled and is represented by an XMI file in the file</p>

	<p>management system, but it is not under Version Control. You can edit this Package.</p>
--	---

Apply Version Control To Branches

It is possible to apply Version Control to all Packages within a selected model branch, in a single operation. In this context, a model branch is a Package that is currently selected in the Browser window, and all of the Packages contained within it.

Access

Context Menu	Browser window right-click on Package Package Control Add Branch to Version Control
--------------	---

Apply Version Control to all Packages within a selected model branch

Step	Action
1	On the 'Apply VC to Branch' dialog, click on the drop-down arrow in the 'Version Control Configuration' field and select the configuration to use.

2	<p>Optionally, tick the checkbox 'Export as Model Branch'.</p> <p>Once the Version Control operation is complete a Model Branch file (.EAB file) is created for this branch.</p>
3	<p>Click on the OK button.</p> <p>The system creates a number of sub-folders within the Version Control working copy folder, then exports all of the Packages within the selected model branch. The system generates filenames for the XMI files, based on the Package GUIDs.</p>

Notes

- The Version Control configuration to be used in this operation must be defined within the model before selecting this command
- When invoked on the model root node, this command applies Version Control to every Package within the model

Fundamental Usage

Once your Version Control product is installed and you have created a suitable environment, Enterprise Architect can make use of that environment to control the Packages in your project. The fundamental Version Control functions are outlined in this table.

Fundamental Functions

Facility	Detail
Define Version Control Settings	Version Control Configurations are used by Enterprise Architect to communicate with your Version Control system. You define one or more Version Control configurations in your project and then use those configurations to control the Packages in your project.
Configure a Package	To put a Package under Version Control you mark the Package as a controlled Package, specify the Version Control configuration to control it, and associate an XMI file with the Package.
Check Out a Package	Checks out the Version Controlled Package currently selected in the Browser

	<p>window, so that you can update modeling objects within it.</p>
<p>Undo Check Out of a Package</p>	<p>Reverses the check-out of a Package, discarding any modifications that have been made by restoring the Package content to the latest revision held in Version Control.</p>
<p>Check In a Package</p>	<p>Checks in the Package currently selected in the Browser window.</p> <p>Checking-in updates the reference version of a Package or group of Packages in the model.</p>
<p>Check In a Model Branch</p>	<p>Checks in all Packages involved in a particular unit of work, as a single operation.</p> <p>Checking-in updates the reference version of a Package or group of Packages in the model.</p>
<p>Check Out a Model Branch</p>	<p>Checks out all Packages within a selected model branch as a single operation, so that you can update modeling objects within them.</p>
<p>Import a Package</p>	<p>Retrieves Packages from Version Control that have been created by other users, or</p>

From Version Control	by you in another model, and imports them into your current model.
Apply Version Control to a Model Branch	<p>Applies Version Control to all Packages within the selected model branch, in a single operation.</p> <p>In this context, a model branch is a Package in the Browser window, and all of the Packages contained within it.</p>
View Package Revision History	<p>Displays the change history of Version Controlled Packages.</p> <p>You can also check out a prior revision of the Package for editing, effectively rolling-back to a prior revision of the Package.</p>

Package Version Control Options

When you have set up a Package for Version Control, you gain access to a range of Version Control operations that can be performed on that Package, such as:

- Open the dialog for working with baselines of the Package
- Check-in and check-out single Packages or a selected hierarchy of Packages
- Update Packages to the latest revision from the Version Control repository
- Inspect the revision history or properties of the XMI file associated with a Package
- Revert a Package to a previous revision
- Compare the current model content of a Package, against the latest revision of the Package in Version Control
- Import and export hierarchies of Packages (model branches) to and from the model, through the Version Control system
- Synchronize the status of a Package, with the Version Control system

Access

Context Menu	Right-click on Version Controlled Package > Package Control
--------------	---

Options

Option	Action
Check In Branch	<p>Check-in Packages contained in the currently selected model branch (that is, the selected Package and all of its child Packages).</p> <p>The 'Select Packages to Check In' dialog lists all Version Controlled Packages within that branch that are checked out to you; you can then select Packages in the displayed list, to be submitted for check-in.</p> <p>You can also choose to keep the Packages checked-out after committing a new revision to Version Control.</p>
Check Out Branch	<p>Recursively check out all Packages contained within the currently selected model branch (that is, the selected Package and all of its child Packages) that are Version Controlled and checked-in.</p>
Check In	<p>Commit a new revision of the currently</p>

	<p>selected Package to the Version Control repository and lock the Package against further editing.</p> <p>Only available for Packages that you have checked-out yourself.</p>
Check Out	<p>Synchronize the currently selected Package with the latest revision from the Version Control repository and unlock the Package to allow editing.</p> <p>Only available for Packages that are not already checked-out (and whose associated Package file is not checked-out).</p>
Undo Check Out	<p>Restore the selected Package to the latest revision in the Version Control repository and lock the Package against further editing.</p>
Put Latest	<p>Commit a new revision of the currently selected Package to the Version Control system, while keeping the Package checked-out.</p> <p>This is equivalent to checking a Package in and immediately checking it back out again.</p> <p>Only available for Packages that you have checked-out yourself.</p>

Get Latest	<p>Synchronize the currently selected Package with the latest revision from the Version Control repository.</p> <p>Available only for Packages that are checked in.</p>
Get All Latest	<p>Updates all of the Version Controlled Packages in the project, to the latest revision retrieved from Version Control. Only updates Packages that are currently checked in.</p> <p>Once the latest revisions are retrieved, the system scans all the controlled Packages and fixes any missing cross-references by comparing the Package with its XMI 1.1 file.</p> <p>If the cross-reference information in the XMI does not match the model, the system updates the model with the information from the XMI and records this update in the System Output window. You can roll back such updates by selecting the entry in the System Output window and using the context menu option 'Rollback Update' (or 'Rollback Selected Updates' if multiple entries are selected).</p> <ul style="list-style-type: none">• Closing the model clears the entries in

	<p>the System Output window</p> <ul style="list-style-type: none">• An entry in the System Output window is also cleared as and when you roll-back the update for it
<p>Scan XMI and Reconcile Model</p>	<p>Scan the Package XMI files associated with each of the project's controlled Packages and restore any diagram objects or cross-references that are detected as missing from the project.</p> <p>This function is useful in team environments where each user maintains their own private copy of the model database (that is, multiple private project files) and model updates are propagated through the use of controlled Packages. It provides no benefit when the model is hosted in a single shared database that is accessed by all team members.</p> <p>Each controlled Package is compared with its associated XMI file and, if the cross-reference information in the model does not match the XMI, the system updates the model with the information from the XMI and records the update in the System Output window.</p> <p>You can roll back such updates by right-clicking on the entry in the System Output window and selecting the</p>

'Rollback Update' option (or 'Rollback Selected Updates' if multiple entries are selected).

Closing the model clears the entries in the System Output window; an entry in the window is also cleared as and when you roll-back the update for it.

This functionality is invoked automatically as part of the 'Get All Latest' operation.

When working in an environment that uses a Private Model deployment and your model contains a significant number of cross-Package references, it is recommended that you invoke 'Scan XMI and Reconcile Model' from time to time, following the re-importation of controlled Packages - for example, after using 'Get Latest' to update a number of Packages - or after performing a number of Package check-outs.

As a general rule, avoid running 'Scan XMI and Reconcile Model' while you have uncommitted changes in your model; generally, you:

- Check-out a number of Packages
- Invoke 'Scan XMI and Reconcile Model'

	<ul style="list-style-type: none"> • Make your modifications • Commit any outstanding changes before you check-out more Packages and run 'Scan XMI and Reconcile Model' again
<p>File Properties</p>	<p>Display Version Control properties pertaining to the XMI export file associated with the currently selected Package; this also identifies who has checked out the Package.</p>
<p>File History</p>	<p>Display change history information for the currently selected Package. Revert to or check-out a prior revision of the Package.</p>
<p>Compare with Controlled Version</p>	<p>Compare the currently selected Package with the latest revision of its associated XMI file retrieved from Version Control.</p>
<p>Add Branch to Version Control</p>	<p>Apply Version Control to all Packages within a selected model branch, in a single operation. In this context, a model branch is a Package that is currently selected in the Browser window, and all of the Packages contained within it.</p>

Export as Model Branch	Export a newly created model branch from your own private copy of a model.
Import a Model Branch	Retrieve a model branch and import it into either the source model or another model.
Get Package	Access Packages in the Version Control repository that are not currently available in your model.
Re-synch Status With VC Provider	Update the Version Control status value recorded for the selected Package in the project to match the value reported by the Version Control provider, without performing an XMI import or export. Use this function when the Package's Version Control status recorded in your project is out of synchrony with the Version Control status reported by your Version Control provider.
Version Control Settings	Display the 'Version Control Settings' dialog.

Notes

- You set up Version Control using options from the project 'Version Control' submenu
- If the selected Package is not under Version Control, a different set of options is available
- If a Version Control configuration has not been defined for the model, no options for using Version Control are available, only the options for configuring Version Control

Check Out a Package

When you need to work on a Version Controlled Package, you check it out. The local XMI file associated with the Package is then checked-out from Version Control. No other user can check out the Package to make changes to it until it has been checked in again.

Access

Context Menu	Right-click on Package > Package Control > Check Out
Keyboard Shortcuts	Ctrl+Alt+L

Check out a single Package

The Package file is imported into your model, and the 'Package' icon is updated to reflect the change in the Package's Version Control status.

When working in a Private Model, if the system detects that the Package content in the model is already up to date with the latest revision of the Package file retrieved from Version Control, then the 'Import Package' dialog displays first. This dialog is not displayed for a Shared Model.

These options are available:

- Force Reload From XMI - reload the Package from XMI regardless of whether it is up to date or not
- Accept current Package - select to skip the process of re-importing the Package from XMI
- Refresh model view - select to refresh the Browser window and diagrams, by reloading the Package content from the project database
- Always use these settings - when selected, if you subsequently check out a Package that is found to be up to date, the same settings are applied again without displaying the dialog

Notes

- If you check out a Version Controlled Package whilst offline, the 'Package' icon has a red figure 8 in front of it
- If you have selected the 'Always use these settings' checkbox and you want to reconfigure the 'Import Package' dialog, press the Ctrl key whilst you select the 'Package Control | Check Out' context menu option; the dialog displays and you can change the settings

Undo Check Out of a Package

If you check out a Package and then decide not to proceed, you can undo the check-out and discard any modifications that have been made, by restoring the Package content to the latest revision held in Version Control. The Package returns to a checked-in state and subsequently can be checked out by any user, including yourself if, for example, you need to reverse incorrect changes before checking the Package out and starting again.

Access

Context Menu	Right-click on Package > Package Control > Undo Check Out
--------------	---

Undo check out of a selected Package

A confirmation dialog displays; click on the OK button.

The latest revision of the Package is retrieved from Version Control and re-imported into your model. The icon against the Package in the Browser window is updated to reflect the change in the Package's Version Control status.

Check In a Package

When you have finished working on the contents of a Package under Version Control, and you want to return it to the model for other users to see, you check it in.

Access

Context Menu	Right-click on Package > Package Control > Check In
Keyboard Shortcuts	Ctrl+Alt+S

Check in a single Package

Step	Action
1	The selected Package is exported and the 'Add Comment' dialog displays. A default comment is provided that contains the current date and time. Optionally, modify the default check-in comment
2	Click OK.

<p>The Package file is checked-in to Version Control and the Package icon is updated to reflect the change in Version Control status.</p>

Check Out a Model Branch

If you need to check out a number of related Packages involved in a particular unit of work, to update the contents, you can do so in a single operation by checking out the whole model branch that contains them.

Access

Context Menu	Right-click on Package > Package Control > Check Out Branch
--------------	---

Check out a sub-tree of model Packages

Step	Action
1	The selected root-node Package and all of its contained sub-Packages are recursively checked out. Any Packages that cannot be checked-out are listed in a message box, with a brief description of the problem; for example: <i>The Package is already checked out by user 'Fred'</i> .
2	When Project Security is enabled in Lock to Edit

<p>mode, Enterprise Architect prompts you to apply a User Lock throughout the selected model branch before proceeding.</p>
--

Check In a Model Branch

If you need to check in a number of related Packages involved in a particular unit of work, and that you have updated, you can do so in a single operation by checking in the whole model branch that contains them. You can also commit new revisions of the affected Packages as you complete milestones, whilst keeping the Packages checked-out for further editing.

Access

Context Menu	Right-click on Package > Package Control > Check In Branch
--------------	--

Check in Packages from within a model branch

Step	Action
1	The 'Select Packages to Check-in' dialog lists all Version Controlled and checked-out Packages within the selected model branch. By default, the entire list is selected.

	<p>Optionally:</p> <ul style="list-style-type: none">• Click an individual Package to select just that Package• Ctrl+click on an individual Package to add or remove it from the selection• Shift+click on a range of Packages to select them• Click on the All button to select all listed Packages• Click on the None button to clear the selection
2	<p>Optionally, you can commit into Version Control a new revision of all selected Packages, while keeping those Packages checked out for further editing. To do this, select the 'Keep packages checked-out after committing new revision' checkbox.</p>
3	<p>Click on the OK button.</p> <p>The 'Add Comment' dialog displays. A default comment is provided that contains the current date and time. This comment is applied to all Packages that are checked in.</p>
4	<p>Optionally, modify the default check-in comment.</p>
5	<p>Click on the OK button.</p> <p>The selected Packages are exported and checked-in. The Package icons are updated to reflect any change in Version Control status. If you opted to keep Packages checked out, there is no change in status.</p>

Update to the Latest Revision of Selected Package

When you are part of a team working in a Distributed Model environment, you will want to periodically update your model with the changes that other team members have committed into Version Control. You can transfer the other users' updates from Version Control into the selected Package in the Browser window.

Access

Context Menu	Right-click on Package > Package Control > Get Latest
--------------	---

Update Package to latest revision

The local XMI file associated with the Package is updated to the latest revision from Version Control. The XMI file is imported into your model database, updating the Package in your model.

When working in a Private Model, if the system detects that the Package content in the model is already up to date with the latest revision of the Package file retrieved from Version Control, then the 'Import Package' dialog displays first. This

dialog is not displayed for a Shared Model.

These options are available:

- 'Force Reload From XMI' - reload the Package from XMI regardless of whether it is up to date or not
- 'Accept current Package' - select to skip the process of re-importing the Package from XMI
- 'Refresh model view' - select to refresh the Browser window and diagrams, by reloading the Package content from the project database
- 'Always use these settings' - when selected, if you subsequently check out a Package that is found to be up to date, the same settings are applied again without displaying the dialog

Notes

- The 'Get Latest' command is disabled for any Package that is checked-out (to anybody) in the currently loaded project
- When using a Shared Model environment, where all users are connected to a single model database, you should reload the Package from the database, rather than using the 'Get Latest' command
- If you have selected the 'Always use these settings' checkbox and you want to reconfigure the 'Import Package' dialog, press the Ctrl key whilst you select the 'Package Control | Get Latest' context menu option; the dialog displays and you can change the settings

Update to the Latest Revision of All Packages

When you are part of a team working in a Distributed Model environment, you will want to periodically update your model with the changes that other team members have committed into Version Control. You can transfer the other users' updates to all Version Controlled Packages into the currently loaded project.

Access

Context Menu	Right-click on Package > Package Control > Get All Latest
--------------	---

Update all Packages in project to latest revision retrieved from Version Control

All the local XMI files for all the Version Control configurations used in the project are updated to the latest revision from Version Control. The system then scans the Packages in the model, to determine which ones are up to date and which are not, compared to the latest revisions of the associated Package files.

A prompt displays, providing these import options for

Packages that are up to date:

- Import changed files only
- Always import
- Prompt for each file

Click on the OK button. The Version Controlled Packages in your project are updated according to the option you selected; if you chose the 'Prompt for each file' option, a prompt displays to confirm import of each file.

Notes

- There is no need to re-import Packages that are already up to date - re-importing Packages first deletes them from the project and then re-imports them from the XMI file, which is time consuming as well as unnecessary; we strongly recommend using the default option 'Import changed files only'
- The 'Get All Latest' command does not update any Package that is checked-out (to anybody) in the currently loaded project; otherwise, any changes not yet committed to Version Control would be discarded
- When using a Shared Model environment, where all users are connected to a single model database, the information in the model database is always the same as, or ahead of, what is committed into Version Control; in this situation, the Get All Latest command will simply refresh your view of the model database, by reloading diagrams or reloading Package content in the Browser window

Review Package History

It is possible to review the change history of Version Controlled Packages by examining previous revisions. If necessary, you can check out one of these earlier revisions of a Package for editing, effectively rolling-back to that prior revision of the Package.

Access

Context Menu	Right-click on Package > Package Control > File History
--------------	---

Review change history of a version-controlled Package

Step	Action
1	<p>For Version Control environments using Subversion, CVS or TFS command line clients, the 'File Version History' dialog displays.</p> <p>Click on a revision number in the 'Revisions' field, to select that revision and view its log entry.</p> <p>For Version Control environments using SCC based</p>

	clients, your particular product opens its own 'File Version History' dialog.
2	<p>On the 'File Version History' dialog, you can optionally click on either:</p> <ul style="list-style-type: none">• Check Out - the selected revision of the Package file is retrieved from Version Control and imported into your model as a Package that is checked out for editing; you can subsequently check in this revision as a new HEAD revision, effectively allowing you to revert the Package to a prior revisionor• Retrieve - the selected revision of the Package file is retrieved from Version Control and imported into your model, but the Package remains flagged as checked-in and cannot be modified; subsequently checking out the Package updates it to the latest revision before it is unlocked for editing

Notes

- If the selected Package was already checked out in the current model, the Retrieve and Check Out buttons are disabled
- If the selected Package contains any sub-Package that is already checked-out in the current model, a warning will

be displayed and the retrieval or check-out will not go ahead

- If you check out a prior revision of a Package, but do not want to commit it as a new revision, right-click on the Package and select Package Control | Undo Check Out

Review Package History - SCC Client

It is possible to review the change history of Version Controlled Packages by examining previous revisions. If necessary, you can check out one of these earlier revisions of a Package for editing, effectively rolling-back to that prior revision of the Package. The process for reviewing the change history of Packages configured for Version Control with an SCC client (including products such as Visual Source Safe, TFS-SCC, ClearCase, Perforce, AccuRev and MKS Source Integrity) differs from that for Subversion, CVS or TFS command line clients.

Access

Context Menu	Right-click on Package > Package Control > File History
--------------	---

Review change history of a version-controlled Package (SCC client)

Step	Action
1	The change history mechanism offered by the third

	<p>party SCC provider displays.</p> <p>To import a prior revision of the Package into your model, use the 'SCC History' dialog to retrieve the revision, then close the dialog.</p>
2	<p>The SCC client notifies Enterprise Architect that a different revision has been retrieved. A prompt then displays, asking whether you want to check-out the prior revision.</p>
3	<p>Optionally, click on either:</p> <ul style="list-style-type: none">• Yes, to check out the prior revision - the selected revision of the Package file is retrieved from Version Control and imported into your model as a Package that is checked out for editing; you can subsequently check in this revision as a new HEAD revision, effectively reverting the Package to the prior revision <p>OR</p> <ul style="list-style-type: none">• No, to import the prior revision as read-only - the selected revision of the Package file is retrieved from Version Control and imported into your model, but the Package remains flagged as checked-in and cannot be modified; subsequently checking out the Package updates it to the latest revision before it is unlocked for editing

Notes

- If the selected Package was already checked out in the current model, the system does not proceed with retrieving a prior revision
- If you check out a prior revision of the Package, but do not want to commit it as a new revision, right-click on the Package and select 'Package Control | Undo Check Out'

Retrieve Prior Revision - SCC Client

Depending on your Version Control product, retrieving a prior revision of a controlled Package can involve a number of prompts regarding overwriting the current local copy.

This example details retrieval of a prior revision from a TFS-SCC Version Control configuration.

Access

Context Menu	Right-click on Package > Package Control > File History
--------------	---

Example Procedure - retrieve prior revision, TFS-SCC client

Step	Action
1	Display the 'TFS File History' dialog.
2	Click on the Get button. The TFS-SCC client displays the 'Resolve Conflicts' dialog.

	<p>This dialog offers the 'Automerge All XML Package files' option. DO NOT select this option.</p> <p>It is important to prevent any merging of Enterprise Architect's XML Package files.</p>
3	<p>Click on the Resolve button.</p> <p>The TFS-SCC client displays the 'Resolve writeable file conflict' dialog.</p>
4	<p>Select the 'Overwrite local file/folder' option.</p> <p>The existing working copy of the Package file is overwritten by the prior revision retrieved from Version Control.</p>
5	<p>Click the OK button.</p> <p>The TFS-SCC client redisplay the 'Resolve writeable file conflict' dialog; it should now show no conflicts.</p>
6	<p>Click on the Close button.</p> <p>The TFS-SCC client redisplay the 'File History' dialog.</p>
7	<p>Click on the Close button.</p> <p>Enterprise Architect displays a prompt, asking whether to check-out the prior revision.</p>
8	<p>Click on the:</p>

- | | |
|--|--|
| | <ul style="list-style-type: none">• Yes button to check-out the prior revision• No button to retrieve a read-only version of the Package, that is NOT checked-out and is NOT editable |
|--|--|

Advanced Usage

Once you get familiar with using the fundamental functions of Version Control there are a number of more advanced functions that you might want to use in working with your models. The advanced Version Control functions are outlined in this table.

Advanced Functions

Export a Version Controlled Model Branch	Exports Version Control information about the root Package of a model Branch, that is used to simplify the process of exporting and importing a hierarchy of Packages from one model to another.
Include Other Users' Packages	Other users might be developing Packages in their own models that you could use in your model, or you might have other models containing Packages that you want to use in the current model.
Import a Model Branch From	Uses Enterprise Architect's Model Branch files, of which there are few, to retrieve information about the root Package file

Version Control	<p>and to import the model branch.</p> <p>Model branch files can simplify the process of exporting and importing a hierarchy of Packages from one model to another.</p>
Add Connectors To Locked Elements	<p>Generally, when working in a diagram containing locked elements, you cannot add a connector to a locked element. There are scenarios in which a connector can be created on a locked element depending on the locking status of the parent Packages.</p>
Validate Package Configurations	<p>You can test the validity of the Version Control settings associated with each Version Controlled Package within your current model.</p>
Resynchronize the Status of Version Controlled Packages	<p>Re-synchronizes the Version Control status of Packages within your project with the status reported by your Version Control provider.</p>

Include Other Users' Packages

Other users might be developing Packages in their own models that you could use in your model, or you might have other models containing Packages that you want to use in the current model. Unless you are sharing an SQL database or project file, those Packages are not automatically available to you. However, if the Packages have been placed into Version Control, you can import them into your model as children of one of your model's Packages.

Access

Context Menu	Right-click on Package > Package Control > Get Package
--------------	--

Import Packages from Version Control into current model

Step	Action
1	On the 'Get Shared File' dialog, click on the drop-down arrow of the 'Version Control Configuration' field and select the Version Control

	<p>configuration associated with the Package to retrieve.</p> <p>The file list is populated with the names of files available through that configuration, for retrieval and import into your model.</p>
2	<p>Click on the Package file to import into your model and click on the OK button.</p> <p>The Package file is imported as a new child Package, under the parent Package you selected.</p>

Notes

- You must have access to the Package files through the Version Control system and you must define a Version Control configuration through which to access those files
- The Version Control configuration must use the same unique ID that was originally used to add the Package to Version Control
- XMI Package files associated with Packages that are already part of your project, are NOT included in the list of files available for import

Export Controlled Model Branch

Applying Version Control to a model can result in many XMI files being placed under Version Control. It might then be hard to locate and import the file corresponding to the root of a particular model branch. Using Model Branch Files (.eab files) overcomes this problem by making it easier to export and import Package hierarchies from one model to another.

You could export a newly created model branch from your own private copy of a model so that, for example:

- Another user can import that branch into their own private copy of the same model
- It can be imported for inclusion as a common branch in a number of different models

Access

Context Menu	Right-click on Package > Package Control > Export as Model Branch
--------------	---

Create a Model Branch File to represent a Package hierarchy stored in Version Control

Step	Action
1	<p>On the 'Export as Model Branch' dialog, in the 'EAB Filename' field, type a name for your Model Branch File.</p> <p>Alternatively, click on the  button and browse for the file location.</p> <p>Note that the Package name is supplied as a default.</p>
2	<p>Click on the OK button.</p> <p>A branch file is created to represent the selected Package. The branch file is committed to Version Control using the same Version Control configuration that controls the Package you selected.</p>

Notes

- You can specify any file name, including sub-folder names, as long as the file is contained in or below the working folder of your Version Control configuration
- The facility is only enabled for Packages that are already under Version Control

Import Controlled Model Branch

Applying Version Control to a model can result in many XMI files being placed under Version Control. It could then be hard to locate and import the file corresponding to the root of a particular model branch, if you want to:

- Retrieve a model branch created by another user in a private copy of a model, to import it into your own private copy of the same model
- Retrieve a model branch that is common in many models, for inclusion in a new model

Model Branch Files overcome this problem by simplifying the retrieval of Package hierarchies for use in other models. You use Enterprise Architect's Model Branch Files, of which there are few, to retrieve information about the root Package file - such as the name and type of the Version Control configuration for the selected Package, and the relative filename of the Version Controlled XMI file associated with the Package. The system then uses this information to import the branch into your model.

Prerequisites

Before you begin, you must have:

- An operational Version Control environment that can be accessed by Enterprise Architect, and
- All of the Version Controlled Package files and the model branch file associated with the model branch to import, in

a valid and accessible working copy folder

Access

Context Menu	Right-click on target Package for import > Package Control > Import a Model Branch
--------------	--

Import a Model Branch

Step	Action
1	<p>On the 'Import VC Model Branch' dialog, either:</p> <ul style="list-style-type: none"> Use the lower portion of the dialog to select a model branch file (this is the simpler option if the associated Version Control configuration has already been saved in the current model; continue to step 2) <p>OR</p> <ul style="list-style-type: none"> Click on the Find a Model Branch (.EAB) file button (this option is useful when you have not yet defined the Version Control configuration that is associated with the model branch to be imported; see the <i>Manually Locating Model Branch Files</i>)

	topic)
2	<p>Click on the drop-down arrow in the 'Select a Version Control Configuration' field and select a configuration.</p> <p>A list of .eab files controlled by that configuration is displayed in the 'Select a Model Branch (.EAB) file' list.</p>
3	<p>Select the Model Branch File you need, then click on the OK button.</p> <p>The system imports the root Package specified in the Model Branch File and recursively imports and populates all the sub-Packages contained in the root Package.</p>

Notes

- The Import a Model Branch command is only enabled for Packages that you (the current user) are able to edit, as the imported model branch is inserted into the model under your selected Package

Manually Locating Model Branch Files

When importing a Model Branch File from Version Control, you might not have the associated Version Control configuration saved in the model that is receiving the import. In this situation, it is simpler to manually browse the file system to locate the Model Branch File (.eab) and let Enterprise Architect derive the details of the configuration from the branch file you select.

Prerequisites

Before you begin, you must have:

- An operational Version Control environment that can be accessed by Enterprise Architect, and
- All of the Version Controlled Package files and the model branch file associated with the model branch to import, in a valid and accessible working copy folder

Access

Context Menu	Right-click on target Package for import > Package Control > Import a Model Branch : Find a Model Branch (.EAB) file
--------------	---

Locate the Model Branch File

Step	Action
1	Access the 'Import VC Model Branch' dialog, then browse for and select the Model Branch File that represents the model branch to import.
2	Click on the Open button. If the Version Control configuration referenced by the file is fully defined within the current model, the import commences at this point. Otherwise, Enterprise Architect displays a dialog prompting you to complete the required configuration.
3	Click 'Yes' to proceed with completing the definition of the Version Control configuration. The 'Version Control Settings' dialog is displayed.
4	Complete the definition of the configuration. (Typically this involves simply specifying the working copy folder.)
5	Click on the Save button. The configuration details are saved.

	The import of the model branch proceeds.
--	--

Notes

- The Import a Model Branch command is only enabled for Packages that you (the current user) are able to edit, as the imported model branch is inserted into the model under your selected Package

Add Connectors To Locked Elements

Generally, when working in a diagram containing locked elements, you cannot add a connector to a locked element. However, this depends on the lock status of the source and target elements (or more precisely, the lock status of the parent Packages of the source and target elements, when the source and target element are held in different Packages). There are scenarios in which a connector can be created on a locked element.

Lock Scenarios

Element Status	Add Connectors
Source unlocked, target unlocked	Yes, any kind of connector can be added
Source unlocked, target locked	Yes, except for Composition connectors
Source locked, target unlocked	No, except for Composition connectors

Source locked, target locked	No, prohibited for all connectors
------------------------------------	-----------------------------------

Notes

- A connector can be added if its source is unlocked - you are modifying what the source can see
- The exception is Composition connectors, where the target (the parent) must be unlocked - you are modifying the parent by adding children

Validate Package Configurations

Having defined the Version Control settings for your current model, you can test the validity of those settings associated with each Version Controlled Package within the model.

Access

Ribbon	Settings > Version Control > Check Configuration
--------	--

Validate Version Control settings

Step	Action
1	<p>The validation process scans the model database and verifies that the Version Control configuration associated with each Version Controlled Package is fully specified in the current model. It also queries the corresponding Version Control provider to find the status of the Package file associated with each Version Controlled Package.</p> <p>The results of the validation process are sent to the System Output window.</p>

2	Open the 'Version Control Settings' dialog to complete the definition of any invalid or missing Version Control configurations.
3	Click on an error message in the System Output window to highlight the corresponding Package in the Browser window.
4	Right-click a Package node and select 'Package Control Configure Package' to open the 'Package Control Options' dialog. Correct any problems with the Version Control details for the Package. Correct any problems with the Package's associated XMI file.

Resynchronize the Status of Version Controlled Packages

It is possible to update the Version Control status of Packages within your project to re-synchronize with the status reported by your Version Control provider. This can be useful if you are creating copies of your project, where checking in a Package from one copy of the model leaves the Package in the second copy of the model with an out-of-date Version Control status.

For a given Package, the re-synchronization process queries the corresponding Version Control provider to find the status of the Package file associated with the Version Controlled Package. If necessary, the process then updates the Package flags within the model database, to synchronize the Package status recorded in the model with the value reported by the Version Control provider.

Access

Ribbon	Settings > Version Control > Re-Synch Status (applies to all Packages in model)
Context Menu	Right-click on Package > Package Control > Re-synch Status With VC Provider (applies to single Package only)

Resynchronize Version Control status

Step	Action
1	The results of the re-synchronization process are sent to the System Output window.
2	Double-click on any result message to select, in the Browser window, the corresponding Package.

Notes

- This process does not cause any Package data to be either exported from your model to the associated Package file, or imported from a Package file into your model's Package data
- If a Package has been checked-out and modified with Enterprise Architect, but your Version Control provider reports the Package file as checked-in, running this process marks the Package within Enterprise Architect as being checked-in, without exporting and committing the pending changes; subsequently checking-out the Package imports the latest revision of the Package file from Version Control, effectively discarding the uncommitted modifications from the model

- Similarly, if a Package file is checked-out to you in your local working copy folder, but not in the Enterprise Architect model, running this process marks the Package within the model as checked-out, but it does not import the associated Package file from the Version Control system; consequently, it is possible to check-in a Package from Enterprise Architect that is potentially out of date, compared to the latest revision of the Package file within the Version Control system

Performance Considerations

This topic presents a few 'best practices' for version control that improve model performance, along with a short explanation of how that benefit is realized.

Apply Version Control to All Packages

Apply Version Control to each and every package within your model. This is easily achieved using the convenience function "Add Branch to Version Control".

Version Control performance can be dramatically improved by following this practice.

The mechanism used for applying Version Control in Enterprise Architect is to export the information describing a package and its contents, from the model database to an XMI file, which is then added to the version control repository. If version control is applied only to the top-level package, then the entire model is exported and saved to a single XMI file. Every time you update the package from version control, for either a "Check Out" or a "Get Latest", the package and its contents are first deleted from the model database, before being re-imported from the associated XML file. In this case, the entire model would be deleted from the database, before being re-imported from XML. By contrast, if *all* packages are version controlled, then only a tiny portion of the model is exported to each XML file and only a tiny portion of the model is deleted and re-imported when checking-out or updating a package.

Concurrent access for editing the model is also vastly improved by following this practice.

When a version controlled package is checked-out, that package and its contents are locked to other users - only the user who has checked-out the package can edit it. If version control was applied only at the top-level package, when one user checks out that package, then the entire model would be locked, preventing any other team members from making modifications until the top-level package is checked in by the first user and subsequently checked out by the other. If, on the other hand, version control is applied at multiple levels within a package hierarchy, independently controlled sub-packages remain unaffected when the parent package is checked out. So, if one user checks out a package to make modifications, a second user can still check out a separate package at the same time and make modifications to that package.

Select "Import Changed Files Only" for Get All Latest

The performance of the "Get All Latest" function, is dramatically reduced by re-importing package files that have not changed. So, for best performance do not re-import unchanged package files. When the "Get All Latest" command is invoked, you will be prompted to select which files to import. You should always choose the option "Import Changed Files Only".

For Shared Model environments, when the option "Import Changed Files Only" is used, the Get All Latest command will simply refresh your view of the model, by reloading diagrams and Browser window content, from the model database. If you select "Always import" or "Prompt for each file", you are forcing Enterprise Architect to delete the package from the model database, then re-import exactly the same information back into the model.

When using a Shared Model environment, where all users are connected to a single model database, there is *never* any need to re-import package files from version control. The information in the model database is always the same as, or ahead of, what is committed into Version Control. In this situation, the information in version control has been exported from the model database before being committed into version control. You simply cannot import new information into the model from the version control repository. When using a Private Model environment, where each user connects to a private copy of the model database, there is still no benefit in re-importing package files that have not changed since your last update. It only extends the time taken for the operation to complete.

Use a Single Version Control Configuration to Control All Packages in Model

Minimising the number of Version Control configurations in your model will result in a faster model loading time. Using multiple Version Control configurations in a single

Enterprise Architect model will extend the time taken to load the model.

While it is possible to use many different Version Control Configurations to control different packages in your model, unless you have a specific reason to this, then you should use just one configuration for all packages in the model.

When Enterprise Architect loads a model that uses version control, it verifies that it can communicate properly with each of the Version Control configurations as the model is loaded. Depending on the version control provider, EA issues a command such as "status" in the working copy folder associated with the Version Control configuration, which verifies that the working copy folder exists and can be accessed and that the version control client can communicate with the version control server. All of this takes time. When there are many Version Control configurations in one model, this can have a significant impact on the time it takes to load your model.

More Information

The Version Control feature in Enterprise Architect allows users to check out a Package, locking it from modifications by other users until it's checked back in. You can then make changes to the Package, adding new elements, modifying existing ones, or deleting others. Once your changes are complete and you're ready to share them with other modelers, you can check in the Package, requiring other modelers to do a Get Latest to fetch the new changes from the Version Control Server.

Edition Information

- Version Control facilities are available in the Professional, Corporate, Unified and Ultimate Editions of Enterprise Architect.
- A team needs to provide their own Version Control Server and Client that are compatible versions.

Notes

- Sparx Systems strongly urge you not to manipulate Version Controlled Package files outside of Enterprise Architect; it is possible to leave the Package files in a state that Enterprise Architect cannot recognize
- Database replication should not be combined with Version Controlled Packages

- If the Packages under Version Control contain any alternative images and those images are subject to frequent change, you can set the 'Export alternate images' option on the 'Preferences' dialog to export the images to the Version Control repository when you check in the Packages; if the images are not subject to frequent change, do not select this option and instead use 'Export/Import Reference Data' to manage alternative images

Compare Projects

Compares a Source and Target Repository for Differences

The Compare Project facility provides a summary of the changes to a repository by providing a comparison of the number of rows in each system table in the source and the target repositories. The modeling information contained in an Enterprise Architect repository is stored in a set of tables in a relational database. These are system tables that allow you to compare the number of rows in each of the tables, which will provide valuable insights into the differences between two repositories. The tables (with rare exceptions) have intuitive names as indicated by these examples:

- t_attribute - stores element attributes
- t_diagram - stores diagrams
- t_object - stores elements
- t_package - stores Packages (folders)

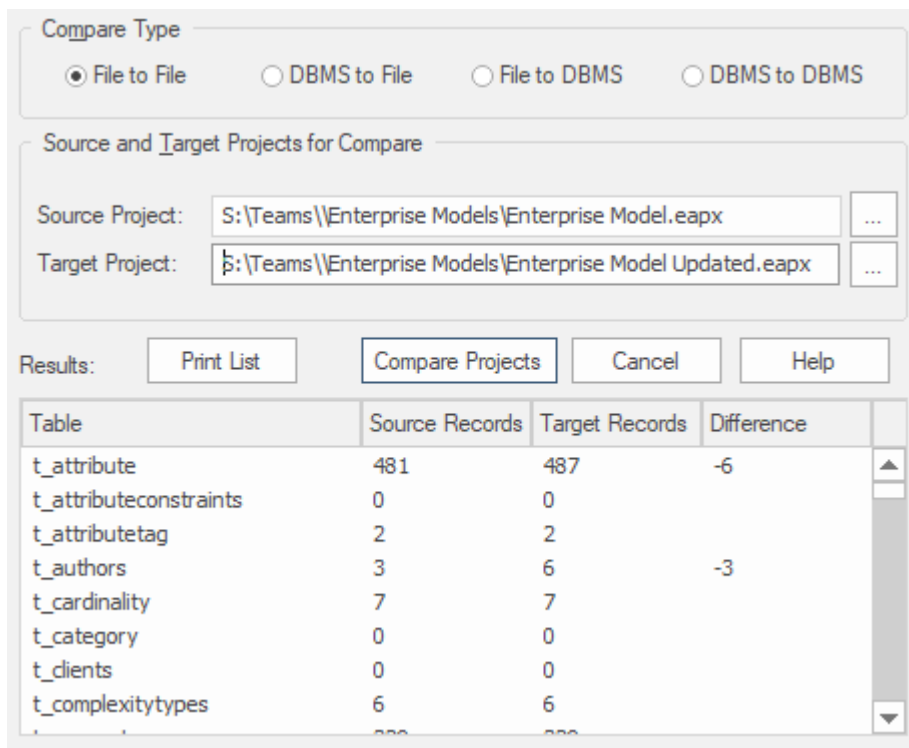

Apart from the deliberate changes that you and other modelers make when working on your repository, a number of operations can also make changes to your project that you either want to monitor carefully or that you do not want to retain. Such events include:

- Recovering from a database problem
- Restoring a backup
- Performing a Project Data Transfer
- Importing from XMI, and
- Deleting model elements

You might have made a copy of the original project, or the purpose of the operation is to generate a copy, in which case you can compare the size and row counts of the 'before' and 'after' copies as a convenient 'sanity check' that the two repositories are equivalent. The repositories can be on different platforms and the comparison can be made

between files and server based repositories as described here:.

- Compare a project file to another project file (e.g. a *.qeax file and a *.feap)
- Compare a project file to a DBMS-based repository (e.g. a *.qeax file and an Oracle db)
- Compare two DBMS repositories (e.g. a MySQL db and an Oracle db)

The comparison examines the number of rows in each database table, producing a report indicating the total records in each and the difference in record count between the two. If discrepancies are found, you would need to investigate further manually. The comparison does not examine the actual data in the tables but rather provides the summary in the form of table row counts

Access

Ribbon	Settings > Model > Integrity > Project Compare
--------	--

Compare two projects

Step	Action
------	--------

1	<p>On the 'Project Compare' dialog, select the radio button for the database types of the two projects you want to compare:</p> <ul style="list-style-type: none">• File to File• DBMS to File• File to DBMS• DBMS to DBMS
2	<p>In the 'Source Project' and 'Target Project' fields, select the connection strings for the source and target projects.</p>
3	<p>Click on the Compare Projects button.</p> <p>The results of the comparison display in the panel at the bottom of the dialog.</p>
4	<p>If you want to print the results of the comparison, click on the Print List button.</p>

Time Aware Models

The Time Aware Modeling feature allows analysts to create incremental versions of their models by providing easy access to tools that facilitate the migration of elements through multiple versions. It is now easy to see the evolution of a model over different versions, and create new versions of model elements automatically without altering the underlying structure of the 'As-Is' model.

Background

Models by definition are an abstraction of things that exist in the real world. Just as time is an important dimension in the physical world, it is also an important concern with models that represent that world. These are some common situations where time and the evolution of versions is important in modeling:

- Architects use models to document the current state and then move on to the more challenging and rewarding task of defining what the future state will look like, often in a series of transitions
- When new customers are acquired, a Business Analyst is often challenged with describing how a base product should be configured for these different customer groups, resulting in different versions of the same product
- Business Strategists typically prescribe what a Capability model will look like for the organization of the future, resulting in at least two versions of the Capability model

- During mergers and acquisitions, Business Architects are tasked with describing the possible states of the enterprise after the takeover is complete
- Engineers are required to develop better or more efficient solutions to meet the challenges of the future, so define newer and better versions of the solution
- Testers need to be aware of different versions of a product when designing and running test cases
- Infrastructure engineers have to define future environments in response to performance or security concerns, creating multiple versions of servers, devices and even whole facilities

All of these situations require that time is incorporated into the models so that it can be reasoned and made explicit. Enterprise Architect's Time Aware modeling facilities can be used in all these situations, to ensure that time is included as a first class citizen in the models. Time is not measured or modeled in absolute or relative terms, but by representing any number of future states or differences in the form of versions.

Introduction

Time Aware modeling is based on using tools to clone a Package structure (Packages and diagrams only) as a new version, and then selectively over-riding parts of the old version with new elements and relationships using either the 'Clone as New Version' capability or simply adding new material to the model as required. This method allows a

highly selective and incremental revision or development of a model, whilst maintaining traceability to both earlier and later development.

Time Aware modeling is not dependent on Version Control or Baseline functionality, but is an entirely separate capability that helps analysts manage multiple versions or revisions of a model in a consistent and fully traceable manner. Conceptually it is analogous to the branching and merging in a Version Control system but as stated it is a separate and unrelated mechanism.

Benefits

- Easily compare 'As-Is' and 'To-Be' models
- Make changes to subsequent versions without altering the underlying structure of the 'As-Is' diagram
- Get greater control over the evolution and traceability of your overall model
- Create Traceability diagrams that outline each stage of the elements' evolution

Time Aware Model

The screenshot displays the Enterprise Architect interface for a 'Glider Control System' project. The main workspace shows a class diagram with several packages and classes. The 'Glider Control System' package contains 'Dashboard', 'Stick', and 'Airspeed'. The 'Glider Control System::Wings' package contains 'Wings::Ailerons', 'Wings::Spoilers', 'Wings::Flaps', and 'Wings::Airbrakes'. A 'StatusLight' class is also present. The 'Stick' class is highlighted with a yellow border.

Below the diagram, the 'Relationships' table provides details on the connections between classes:

Relationship	Source	Source Version	Target	Target Version	Target Role	Target Cardinality	Navigability	Target Type	Target Stereotype	View
Association	Dashboard	2.0	Stick	2.1			Unspecified	Class		Visible
Abstraction	Stick	2.1	(Stick)	1.0			Source -> Desti...	Class		
Association	Stick	2.1	Wings	1.1		2	Unspecified	Class		Visible

At the bottom of the window, the status bar indicates: 'Class Diagram: Glider Control System: created: 2/06/2016 modified: 2/06/2016 3:16:04 PM 100% 799 x 1134'.

Clone Structure as New Version

When using Time Aware modeling, you will typically want to create a new version of a group of elements that are collected together in one or more Packages, and so will need to create a new version of a whole Package structure.

Creating a clone of your current model structure is a simple migration process driven by version number. The structure migration process builds a clone of your current Package hierarchy, including diagrams, and updates the Packages and diagrams with a user defined version number. You can also change the structure name, if necessary. All diagram elements translated to the clone diagram are included as linked elements (references) to ensure their encapsulation is maintained with the 'As-Is' model.

As the 'To-Be' model evolves, linked diagram elements from the previous version can be selected and automatically cloned into the new Package structure as required. This ensures model assets continue to develop seamlessly between the 'As-Is' and the 'To-Be' model without crossing over.

The facility can operate on Model Packages, Views and lower-level Packages regardless of their location in the Browser window.

Access

--	--

Ribbon	Design > Package > Manage > Clone Structure as New Version
Context Menu	Browser window Right-click on Package Clone Structure as New Version

Create new clone structure

Step	Action
1	On the 'Enter Name and Version' dialog, the 'Name' field defaults to the currently-selected Package name; if necessary, overwrite this with a new name. Type in the version number for the ('To-Be') clone of the selected structure, and click on the OK button. The 'Select Structure destination' browser displays.
2	Select the Package in the project under which to create the clone structure. The <i>current</i> location of the structure is highlighted until you select the clone location.
3	Click on the OK button. The clone structure is inserted under the target Package, and the clone diagrams are all opened within the Diagram View as

separate tabs.

Example

Start with selecting the root of your 'As-Is' model structure.

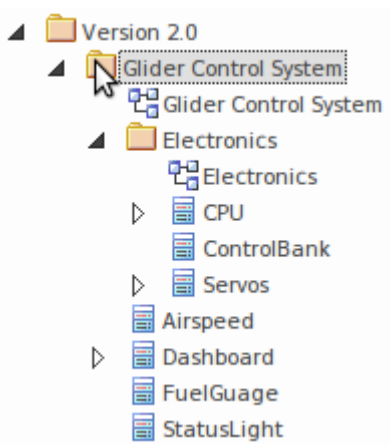

Select the 'Design > Package > Manage > Clone Structure as New Version' ribbon option.

(Alternatively, right-click on the Package and select the 'Clone Structure as New Version...' context menu option.)

Specify the name, version number and the target Package for the structure clone.

Finish with the new 'To-Be' model structure.

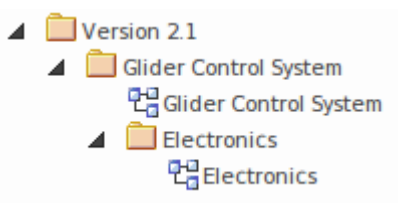

Notes

- All Packages in the new structure will be updated with the newly entered version number
- All diagrams in the new structure will be updated with the newly entered version number
- Elements in the new structure shown in the Browser window are linked elements from the 'As-Is' source Package and retain their 'As-Is' version status
- Note, Text and Boundary elements are cloned into the new version with the diagram
- Object and Sequence elements are copied into the new structure as new elements with the new version number, and with Trace connectors to the original version elements
- On the 'Select Structure destination' dialog, you can either select an existing Package as the destination, or create a new Package

Clone Diagram as New Version

There will be circumstances when a modeler needs to clone a diagram on an ad-hoc basis. Even when the modeler has used the 'Clone Package Structure' facility, a diagram might have subsequently been added to the original structure and this diagram can then be cloned separately to ensure the two versions of the Package structure are kept synchronized.

Creating a clone of your current model diagram is a simple migration process driven by version number. The diagram migration process builds a clone of your selected diagram and updates it with a user defined version number. All diagram elements contained on the clone diagram are migrated as linked elements to ensure their encapsulation is maintained with the 'As-Is' model.

As the new diagram version evolves, linked diagram elements can be selected and cloned into the new diagram's location as required. This ensures model assets continue to develop seamlessly between the 'As-Is' and 'To-Be' models without crossing over.

As you can have a sequence of cloned diagrams in separate Packages, it might not be apparent that a diagram is one of a line of clones. You can check whether a diagram has clones using the 'Show Diagram Versions' dialog.

Access

--	--

Ribbon	Design > Diagram > Manage > Clone as New Version
--------	--

Create new clone diagram

Step	Action
1	<p>On the 'New version number' dialog, type in the version number for the ('To-Be') clone of the selected diagram, and click on the OK button.</p> <p>The 'Select Diagram destination' browser displays.</p>
2	<p>Browse for and select the destination ('To-Be') Package for the clone diagram, and click on the OK button.</p> <p>The diagram is cloned to the destination Package, and automatically opened in the Diagram View.</p>

Example

Select a diagram to clone.

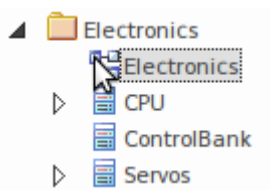

Select the 'Design > Diagram > Manage > Clone as New Version' ribbon option.

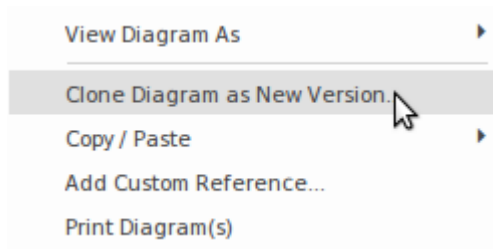

Specify the version number and the target location for the clone diagram. Review the clone diagram when it is automatically opened.

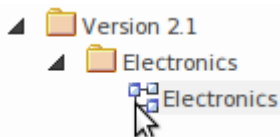

Show Diagram Versions

When a diagram is cloned, a custom reference is added to the diagram (in the `t_xref` table). This custom reference provides information on the clone, through the 'Show Diagram Version' dialog.

To display this dialog, right-click on the diagram in the Browser window and select the 'Show Diagram Versions' option.

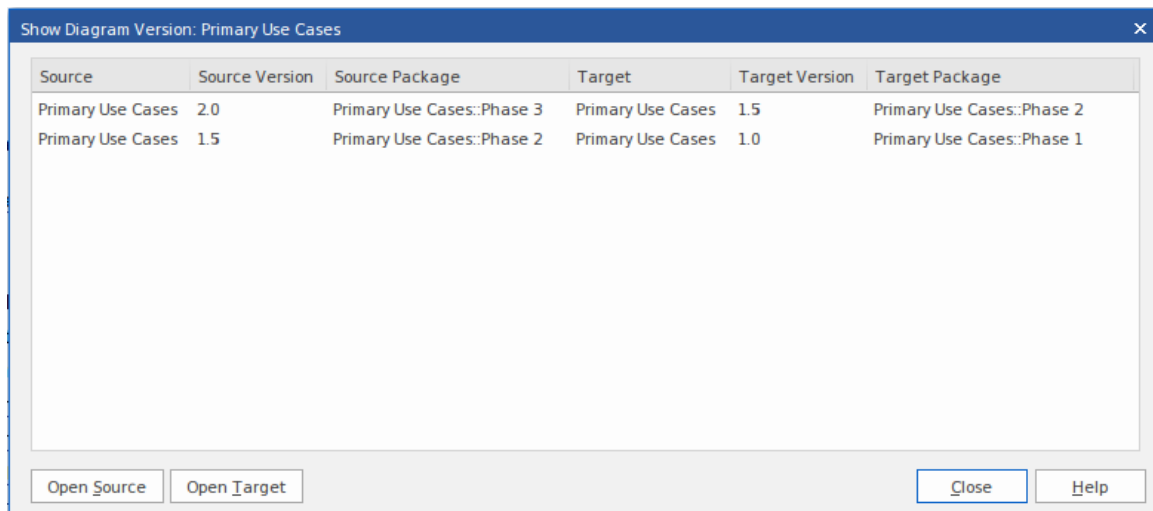

Source	Source Version	Source Package	Target	Target Version	Target Package
Primary Use Cases	2.0	Primary Use Cases:Phase 3	Primary Use Cases	1.5	Primary Use Cases:Phase 2
Primary Use Cases	1.5	Primary Use Cases:Phase 2	Primary Use Cases	1.0	Primary Use Cases:Phase 1

Where there is more than one clone in a sequence, the versions are listed with the most recent first and the original clone last.

You can open either the clone diagram (the source) or the diagram it was cloned from (the target) by clicking on the Open Source button or Open Target button.

You can also right-click on a diagram entry and select from there context menu options:

- Open Source Diagram - display the clone diagram in the Diagram View
- Open Target Diagram - display the cloned diagram in the Diagram View
- Find Source Diagram - highlight the clone diagram in the Browser window
- Find Target Diagram - highlight the cloned diagram in the Browser window

Notes

- Clone diagrams will be updated with the newly entered version number
- Browser window elements in the new structure are linked elements from the 'As-Is' Package source and retain their 'As-Is' version status
- Note, Text and Boundary elements are cloned into the new version with the diagram
- Object and Sequence elements are copied into the new version, with the new version number, and with Trace connectors to the original version elements
- You can either select an existing Package or create a new destination Package in the 'Select Diagram destination' dialog

Clone Element as New Version

Cloned elements are the core of the Time Aware modeling capability. When a clone is made, a new element is added to the 'To-Be' model and a trace relationship is added that connects the new element back to its 'protege' in the 'As-Is' model. This allows details to be added to the cloned element leaving the 'As-Is' element in its original state. Creating clone elements helps maintain seamless development between the 'As-Is' and 'To-Be' model, ensuring changes are well defined, encapsulated and traceable.

Creating a clone of the linked elements on a diagram is a simple migration process driven by version number. The element migration process builds a clone of your selected element and updates it with a user defined version number. In addition to duplicating their base version, the necessary relationships between the clone and the original are created to ensure the logical consistency and traceability of the new model. When cloning an element as a new version, Enterprise Architect intelligently determines where to route the new element's relationships to correctly reflect the intent of the new model version.

Where a relationship exists to another model element in a previous version, the model is examined to see if there is a new version of the target element first and, if so, that element is now used as the target of the relationship. If there is no over-ride, the relationship is set to the existing element. This behavior is extremely useful when studying the impact of making changes to elements in base versions

that are expected to remain unchanged throughout multiple versions of a model's lifecycle.

Access

On a 'To-Be' clone diagram containing an external element (an element held in a different Package) to be cloned, click on the element.

Ribbon	Design > Element > Manage > Clone Element as New Version
Context Menu	On a diagram, right-click on element Clone Element as New Version

Create a new clone element

Step	Action
1	On the 'New version number' dialog, the 'Enter Value' field defaults to the version number of the current diagram as the version number to apply to the clone element. You would tend to use this number but, if necessary, you can overtype it with a different one.

- Click on the OK button. The external element becomes a clone in the diagram's parent Package, with the specified version number.

Example

Select a linked element on the 'To-Be' diagram clone.

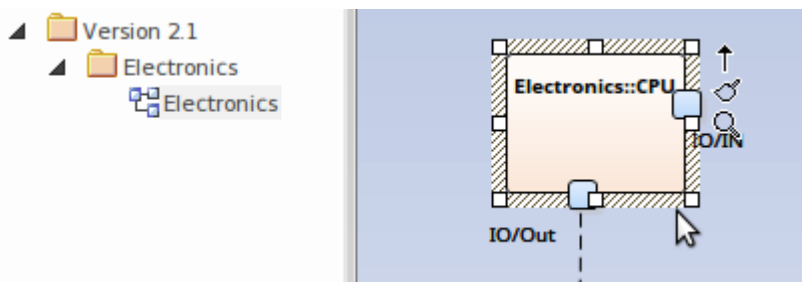

Select the 'Design > Element > Manage > Clone Element as New Version' ribbon option.

Alternatively the option can be found in the diagram context menu.

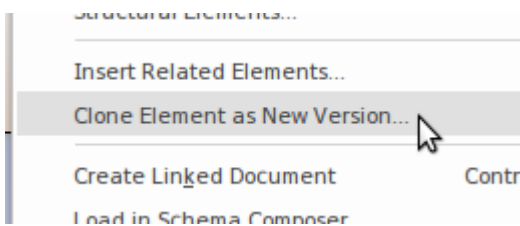

Finish with the new 'To-Be' element.

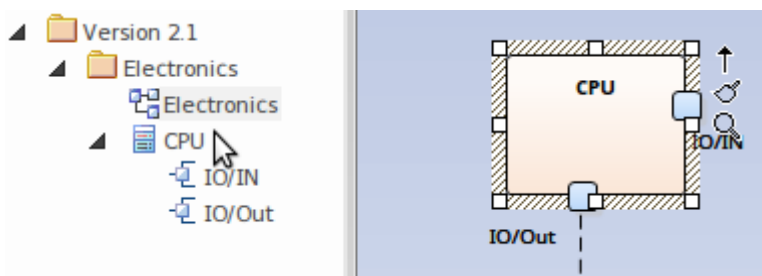

Update linked diagram objects

When an element has been updated to the current version, update diagrams might still contain linked diagram object references to the old version of that element. If you want to make one of these diagram objects the same version as the updated element:

1. Right-click on the object linked to the old version and
2. Select the 'Update Element to Version '%s'' option from the element context menu

This will update the old linked diagram object with the new version of the diagram object.

Notes

- The clone element will be created in the same Package as the current diagram
- When cloning an element, all parent and child elements will also be cloned to maintain element hierarchy
- The 'Clone Element as New Version' menu option is not available for elements contained in the diagram's parent Package
- Package, Note, Text and Boundary diagram elements are excluded from this feature
- The clone element will maintain relationship links with previous version elements
- A Trace relationship link is created between the clone and the source element
- Use the 'Filter to Version' option in the diagram

'Properties' dialog to filter elements by version on the diagram

Traceability

Time Aware models are effective, but it quickly become difficult to understand all the connections between new and existing elements particularly over multiple versions. Enterprise Architect is a collaborative platform and excels at creating visualizations of the relationships and traces between different parts of the model. There are a range of useful and compelling tools that can be used to visualize these relationships.

The Traceability Window

You can use the Traceability window to trace element relationships. Access the window using the 'Design >Element > Trace' ribbon option.

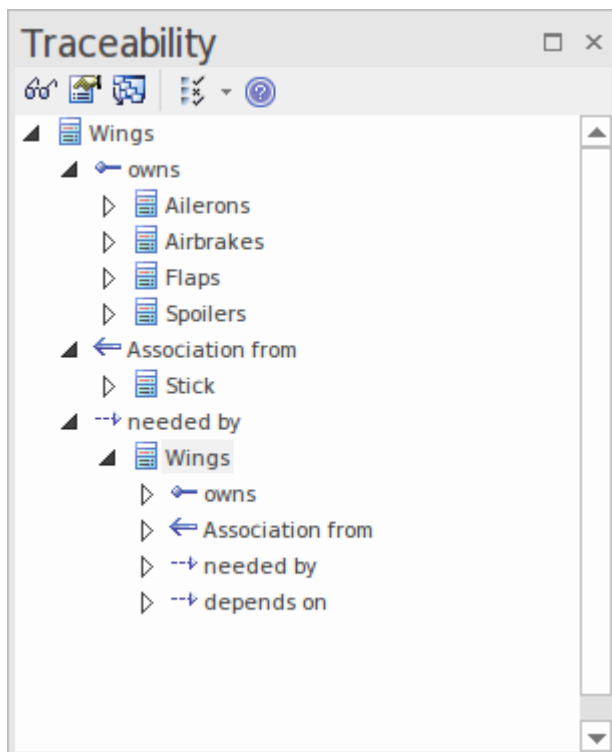

Insert Related Elements

You can use the Insert Related Elements feature to create a Traceability diagram that outlines each stage of the element's evolution.

Step	Action
1	Create a Custom diagram with the name 'Traceability'. (Use 'Technology Type': 'Extended' and 'Diagram Type': 'Custom'.)
2	Drag the subject element from the Browser window onto the diagram.
3	Right-click on the element in the diagram and select the 'Design > Element > Add Element > Related Element' ribbon option. The 'Insert Related Elements' dialog displays.
4	On the dialog: <ul style="list-style-type: none">• Select 'Trace' in the 'Connector types' panel• Set the 'Find Relationships to' depth level• Click on the Refresh button
5	In the list of results, select the checkbox against each required diagram element, and click on the OK button. The elements are added to the diagram.

Example

Drag the required element onto the diagram.

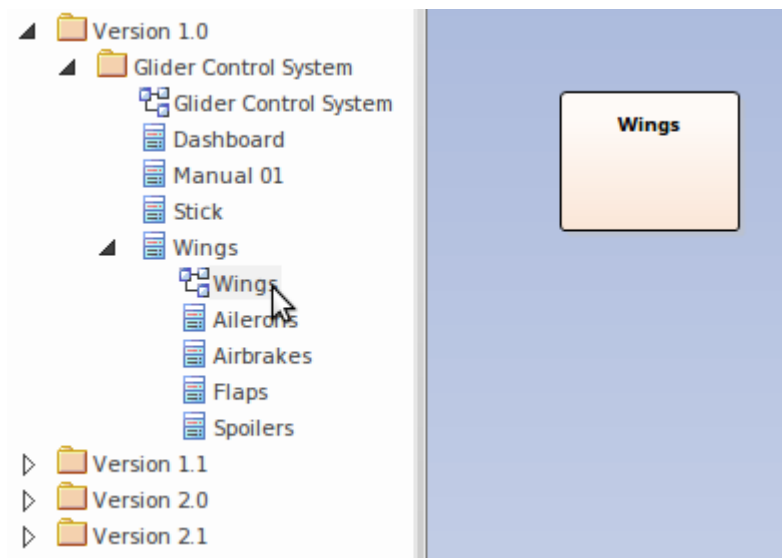

Click on the element and select the 'Design > Element > Add Element > Related Element' ribbon option, or right-click and select the context menu option 'Insert Related Elements...'

Configure the 'Insert Related Element' dialog.

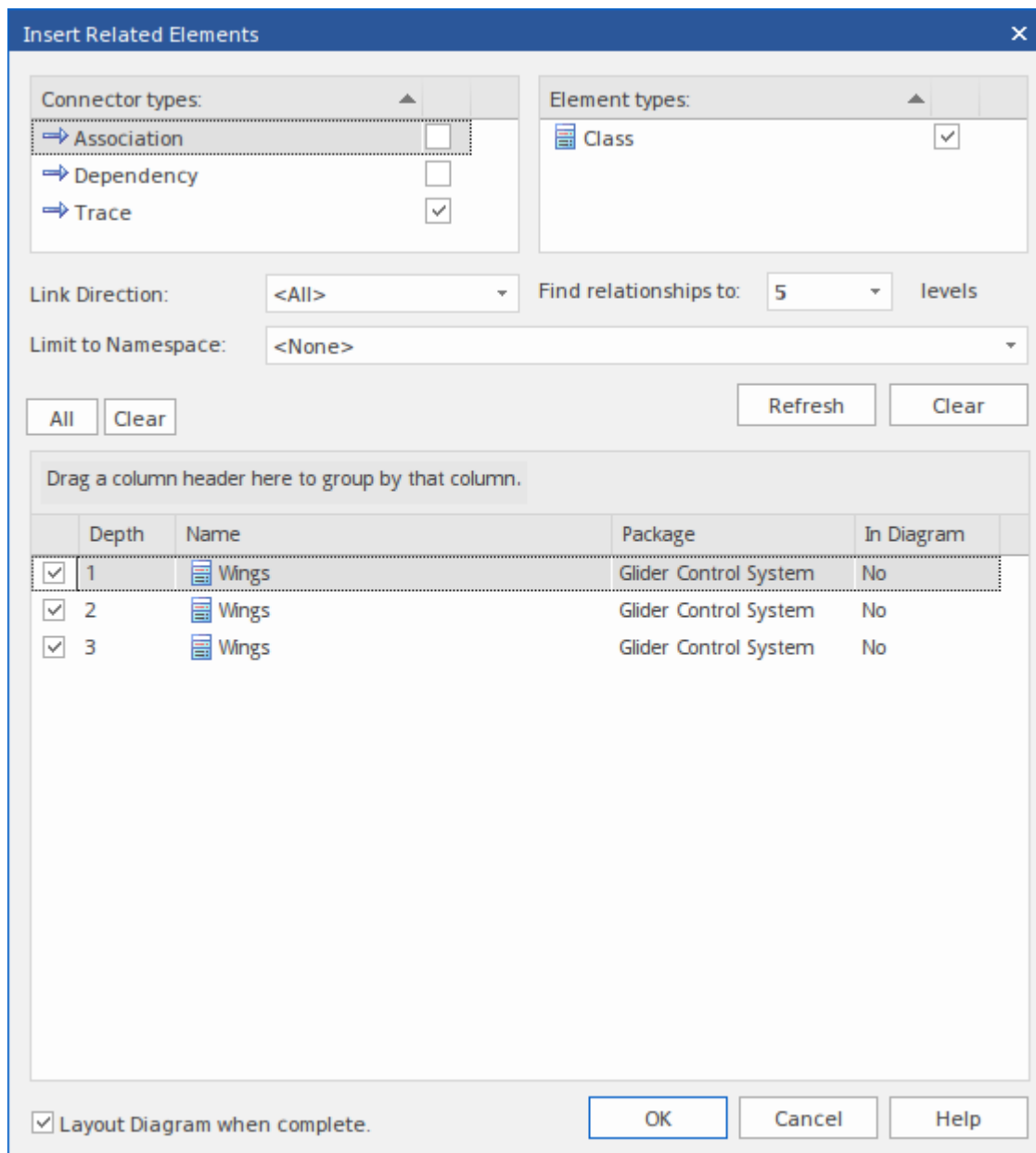

Finish setting the diagram layout and property options, and click on the OK button.

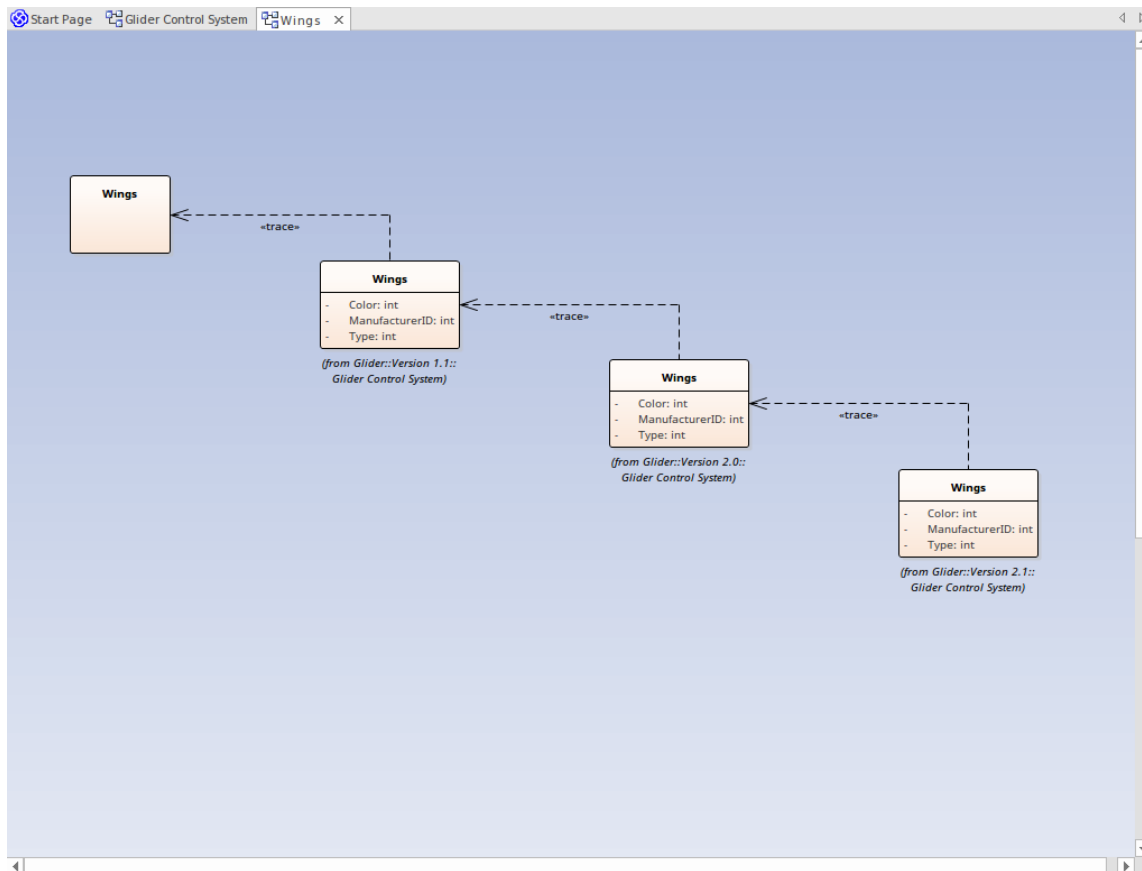

Relationships

The docked Relationships window is a useful tool for viewing the relationships between 'As-Is' and 'To-Be' models. Selecting the 'Source Version' and 'Target Version' report columns brings clarity of relationships.

In the Relationships window, right-click on a selected relationship to open the context menu; you can view properties, find element usage and locate source and target elements.

Relationships										
Relationship	Source	Source Version	Target	Target Version	Target Role	Target Cardinality	Navigability	Target Type	Target Stereotype	View
Association	Stick	1.0	(Wings)	1.0		2	Unspecified	Class		
Association	Stick	1.0	Wings	1.1		2	Unspecified	Class		Visible
Association	(Dashboard)	1.0	Stick	1.0			Unspecified	Class		
Association	Dashboard	2.0	Stick	1.0			Unspecified	Class		Visible

Version Filtering

When working on a diagram containing elements from different versions of your model, you can easily select to filter out elements not in the current version.

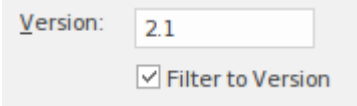
Step	Action
1	Right-click on the diagram background and select the 'Properties' option to display the diagram 'Properties' dialog.
2	The 'Version' field displays the diagram version number; all elements having a version number different from this will be grayed out. 
3	Select the 'Filter to Version' checkbox to enable the diagram filter feature, and click on the OK button.

Filter Example

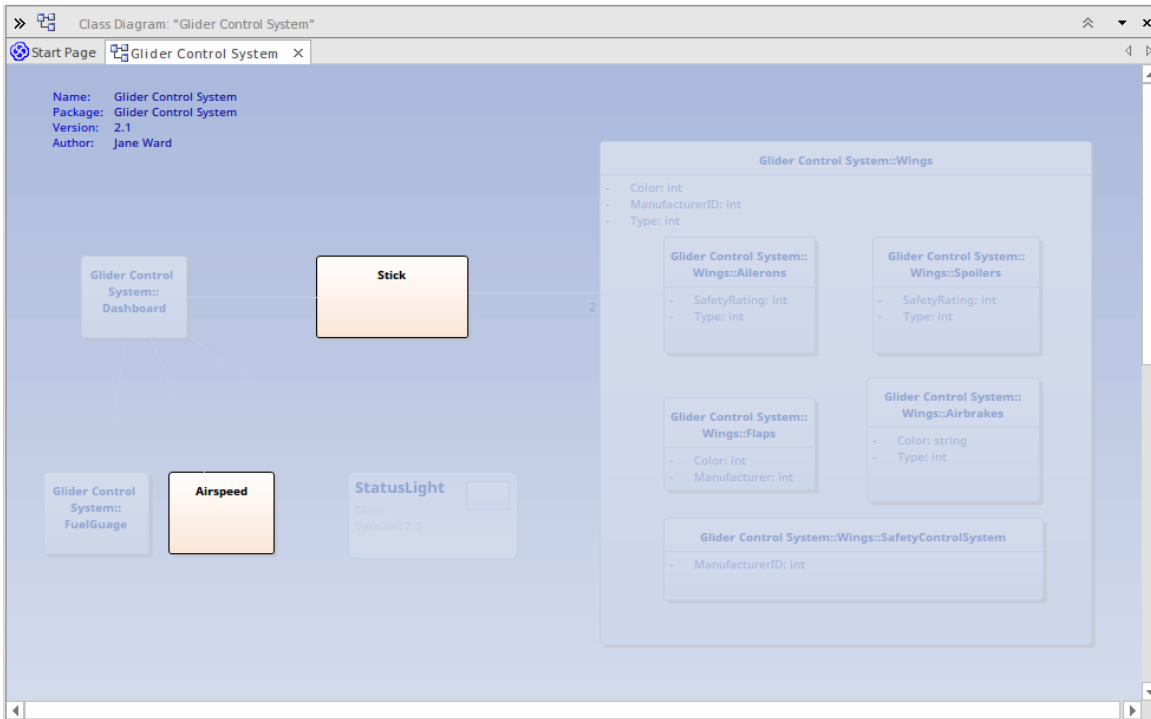

The Specification Manager

In developing a model, you can use a wide range of Enterprise Architect tools to create the model specification. For the preliminary specification, such as defining Requirements, you can adopt one of two general methods:

- Diagram-based, creating UML-defined element icons in, for example, Requirements diagrams, and building the model graphically, or
- Text-based, creating elements as simple text descriptions, sketching out the elements, relationships and properties in a broad definition that you - or team members with more specific roles - can refine and develop into a more complete model

Your 'sketch pad' for the second approach is the Specification Manager.

The Specification Manager is a simple document-based interface to a selected Package or diagram in the model, providing the means of creating and reviewing elements as text representations of objects in the model, using a process that is familiar to all users including business professionals and management, who might not have expertise in model development.

Facilities

The Specification Manager is also an interactive reporting tool for displaying, in icon form, the status of various other features against each entry and providing access to edit each

feature.

In the Specification Manager you can:

- Work on the element entries as paragraph text in the same way as you would edit a document using a word processor; this includes copying or dragging text from an external file into the Specification Manager, and importing data from an external spreadsheet (.csv) file
- Switch easily from element to element in a displayed Package, with a single mouse-click
- Show and edit in-place the current status of a number of properties of each entry
- Directly interface to a range of Enterprise Architect tools that you can quickly invoke to display, edit and discuss the properties of the selected Package or element; these tools span the range of Project Management and Model Management facilities, including:
 - Traceability (Traceability window and Relationship Matrix)
 - Change Management (Baselines and Auditing)
 - Maintenance
 - Testing
 - Risk Management
 - Documentation (document format, web format, and spreadsheet format)
 - Metrics
 - Review and Discussion (Model Library, Discussions, Formal Reviews and Model Mail)

Once any tool window is open, the details reflect the currently-selected element in the Specification Manager, so

you can quickly run through the properties of a number of elements just by selecting them in sequence in the list.

The Specification Manager makes it very easy to develop a simple, visual description of your model for initial specification, ongoing development and program management, with immediate access to a range of types of detailed information on any selected element, should you need this detail.

Specification Manager - Overview

The Specification Manager is a document-based interface to a selected Package in the model, providing the means of creating and reviewing elements as text representations of model objects in that Package. You can rapidly define or edit properties of the elements in the Specification Manager window itself, and also immediately open a range of windows and dialogs to add or review further properties and characteristics specific to each element. A key feature of the Specification Manager is the speed and ease with which you can create, filter and review a large number of elements from one point, and develop or examine complex detail on each element *or not*, as you require.

You also have the facility to switch the display of the contents of a diagram to the Specification Manager view, either completely or as an inline display panel beside the graphical view of the diagram.

Access

Ribbon	Design > Package > Specification View
Context Menu	Right-click on Package Specification Manager
Keyboard	Ctrl+0

Shortcuts

The Specification Manager View

The Specification Manager initially displays as a tabbed view in the application work area, containing a:

- Tailored instance of the Navigator Toolbar
- List header bar of column names, and
- Blank work area

Displaying the Specification Manager automatically opens the 'Specification - Specify' ribbon, which provides a range of options for working in the Specification Manager.

The selected Package defaults to the currently-selected Package or, if none have been selected, the first top-level Package in your model, and the element type defaults to any type held in the Package.

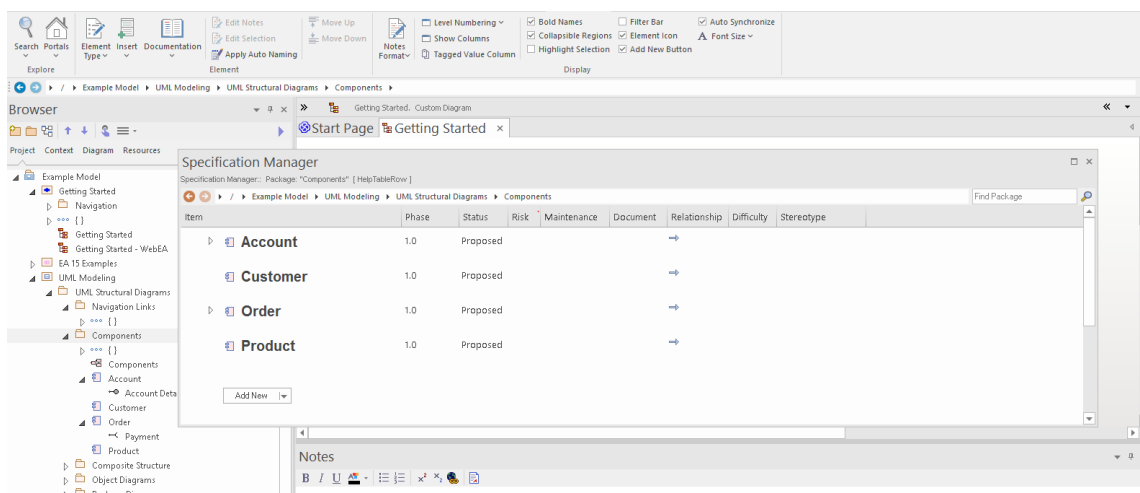

If you prefer, you can drag the 'Specification Manager' tab out of the application workspace and use it as a floating or docked window.

To begin you can either:

- Work with the selected Package, or
- If you have selected the 'Auto Synchronize' checkbox in the Specification-Specify ribbon 'Display' panel, click on another Package in the Browser window to switch to that, or
- Select another Package from the Package path in the Navigator Toolbar, or
- Create and/or select another Package in the 'Project' tab of the Browser window

If you want to select a specific type of element to review, use the 'Element Type' icon in the 'Element' panel of the 'Specification - Specify' ribbon. This also provides the option of switching back to displaying elements of any type in the Package

You can also adjust the column headings to include the columns that show the information of interest to you, and display the Filter bar to further isolate particular elements for review. For an existing Package, the Specification Manager might now resemble this:

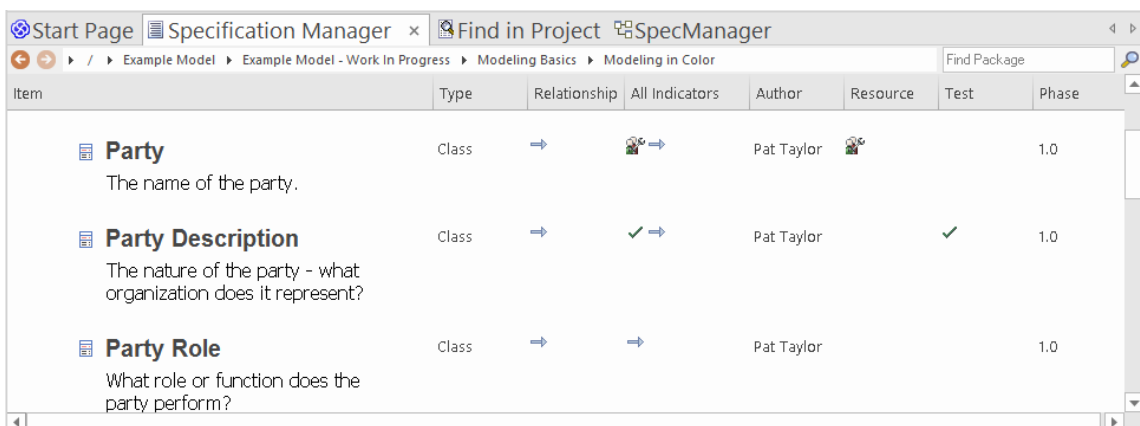

The screenshot shows the Specification Manager window with a table of elements. The table has columns for Item, Type, Relationship, All Indicators, Author, Resource, Test, and Phase. The elements listed are Party, Party Description, and Party Role.

Item	Type	Relationship	All Indicators	Author	Resource	Test	Phase
Party The name of the party.	Class	⇒	👤 ⇒	Pat Taylor	👤		1.0
Party Description The nature of the party - what organization does it represent?	Class	⇒	✓ ⇒	Pat Taylor		✓	1.0
Party Role What role or function does the party perform?	Class	⇒	⇒	Pat Taylor			1.0

The display shows:

- The element icons and names, and any notes they might have (you can configure the display to hide the icons and notes)
- The text values of each property represented by a column, where those values have been set; you can quickly edit any of the values
- Icons in several columns, which indicate that the element has an associated object, file or Linked Document; you can double-click on these icons to display the object properties or document in the window in which it was created and, if necessary, you can edit the details

After you become familiar with what each indicator icon represents, you can display them all within the single 'All Indicators' column to save space.

When you click on an element in the display, it is marked by a vertical colored line in the left margin to indicate that the element is selected, and a vertical or horizontal line against the element property you clicked on, to indicate that the focus is on that property. In the illustration, the Author of the 'Party Description' element is selected. If you click again on the element property, the margin line changes color, to indicate that the property is open for editing. For example:

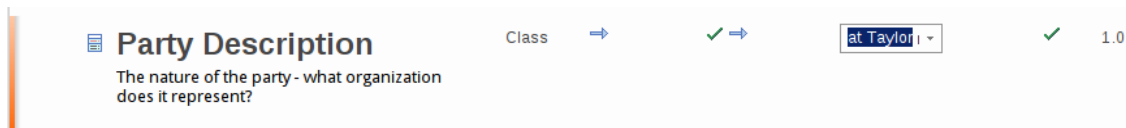

Adding, displaying and changing information

When you create or review an element on the Specification

Manager, you operate through one of four areas:

1. The Navigator toolbar, which provides options to:
 - Change the Package under review
2. The Specification - Specify ribbon, which provides options to:
 - Change the specification element type
 - Set the option to automatically change the display to whatever Package you click on
 - Open tools to create, display or review the properties, characteristics and associated records of the Package or specific elements in the Package
 - Configure the appearance of the Specification Manager display and the types of information you might develop from the data in the display
3. The display area itself, where you can:
 - Perform in-place editing by directly editing text (such as Version, Phase or element notes) or selecting alternative values from drop-down lists (such as Difficulty, Status or Priority)
 - Double-click on an indicator icon and review the record or document attached to the element
 - Drag in elements from any page of the Diagram Toolbox
4. The element context menu, which you can display by right-clicking anywhere on an entry in the display; this provides options for:
 - Creating and deleting elements
 - Editing element properties (including adding and reviewing extended properties, or Tagged

Values)

- Locating the element in the Browser window and
- Refreshing the display

Notes

- In the Corporate and extended editions of Enterprise Architect, User Security can be applied to restrict or enable access to a range of operations and functions; if you cannot access a function in the Specification Manager, check with your System Administrator or Security Administrator to see if you have access permissions to work with that function

Specification - Specify Ribbon

The 'Specification - Specify' ribbon provides a selection of facilities that you might use when creating and editing model elements as a text-based specification, using the Specification Manager. The ribbon becomes available when the Specification Manager is open.

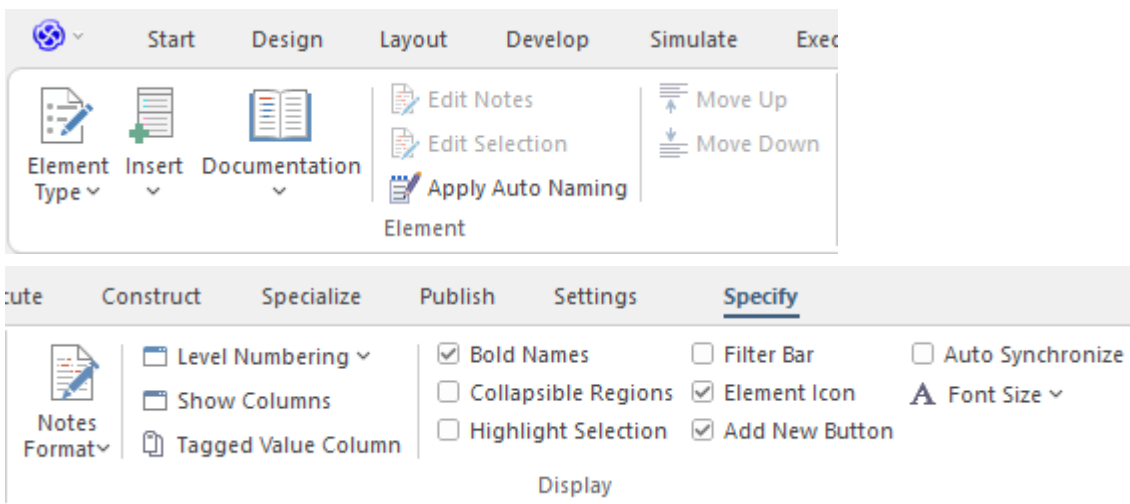

Panels

Panel	Description
Element	The 'Element' panel offers a range of facilities for working with the elements that are displayed in the Specification Manager view. There are facilities for adding new elements and viewing and editing element properties.
Display	The 'Display' panel provides a range of

options that make it possible to tailor the appearance of the Specification Manager view, to better display the information you want to examine. There are options providing visual cues, such as highlighting the selected element and using bold fonts to emphasize element names, as well as options to filter the list of elements that are displayed.

Using the Specification Manager

When you begin working in the Specification Manager, there are three general areas of activity you work through:

- Setting up the Specification Manager to suit your work requirements
- Creating and/or organizing the elements in the View
- Performing whatever work you need to do on the elements

The Specification Manager is extremely versatile, and you can use it very simply to create a set of basic elements or at varying levels of complexity to develop and manage those elements in your project, as you need.

Access

Ribbon	Design > Package > Specification View
Context Menu	Right-click on Package Specification Manager
Keyboard Shortcuts	Ctrl+0

Initial Tasks

Task	Action
Specify the type of element to work on	<p>Either:</p> <ul style="list-style-type: none"> • Work with the default (all element types) or • Select a specific type of element <p>You specify the element type first because when you come to browse for or select the Specification Package, if you have specified a particular element type the system automatically filters the Package selection to only those that contain elements of that type.</p>
Select the Package to work in	<p>Either:</p> <ul style="list-style-type: none"> • Work with the default Package • Select another existing Package in the model, or • Create a new Package in the model
Set up List Header and Filter bars	<p>Use the 'Field Chooser' dialog to organize the columns that contain the type of information you want to work with. You can use the Filter bar to select for information that includes specific values, or hide the Filter bar altogether.</p> <p>Some of the columns contain indicators</p>

	<p>that represent records and documents associated with an element. You can access the item represented by an indicator by clicking on it.</p>
<p>Configure the display</p>	<p>As you begin, or at any other time in your use of the Specification Manager, you can change the appearance of the display to, for example, use smaller or larger text font, partially or totally hide Notes text, or show the element names in bold.</p> <p>You can further configure the display and the element definition by including level numbering and automatic naming, and by applying customized properties such as additional Requirement Types, Glossary entries and Tagged Value Types.</p>

Organize elements

Task	Action
<p>Add new elements</p>	<p>Create new elements in the model as direct members of the Package or as child elements of those members.</p>
<p>Delete</p>	<p>You can filter out elements from the</p>

elements	display by type or according to the value of various properties. However, if an element does not belong in the Package and model, you can delete it completely.
Reorganize elements	<p>The Specification Manager reflects the sequence of elements in the Package as shown in the Browser window.</p> <p>To put the elements in the Specification Manager in a different order, either:</p> <ul style="list-style-type: none">• Move them in the Browser window, then right-click on the Specification Manager and select the 'Reload View' menu option, or• Right-click on the element to move and select the 'Move Up' or 'Move Down' option• Click on the element to move and on the 'Specification-Specify > Element > Move Up' or 'Move Down' ribbon options, or• Click on the element and press Ctrl+Shift+Up arrow or Ctrl+Shift+Down arrow

Review the elements

Task	Action
<p>Create and Review Relationships</p>	<p>You can examine existing relationships and create new ones using the Relationship Matrix, creating and using specific Matrix Profiles.</p> <p>You can also review existing relationships by opening the Traceability window, either from the Toolbar or by double-clicking on the blue arrow displayed in the 'Relationship' and 'All Indicators' columns. If the element has no relationships, the blue arrow is not shown.</p>
<p>Discuss and review elements amongst project members</p>	<p>It is possible to create review documents and have recorded text message discussions on the development of your elements, using the Review, Discussion, and Model Mail facilities.</p> <p>If an element has an existing Discussion or Review, this is represented by a 'speech bubble' icon in the 'Discussion' and 'All Indicators' columns. You can open the discussion by double-clicking on that icon.</p>
<p>Make, Review and</p>	<p>You can easily view and edit elements directly in the Specification Manager or</p>

<p>Manage Changes</p>	<p>by displaying the appropriate window such as the Properties window.</p> <p>You can also monitor changes to the selected Package or element made anywhere in the system, using the Baselines and Auditing Facilities.</p> <p>Further, you can manage changes made by other users, opening the Project Tools window to quickly assign resources and risks to the work on the element. You can review work on the elements in the Package by displaying the Specification Manager in another tab in the form of the Project Gantt chart.</p> <p>Maintenance and Testing are integrated and easily available to help improve software quality from the beginning of your project.</p> <p>Existing records of these items are indicated by icons in the corresponding column, and can be quickly opened by double-clicking on the icon.</p>
<p>Print the list of entries</p>	<p>A print-out of the Specification Manager element list is a document containing a simplified version of the screen display:</p> <ul style="list-style-type: none">• All elements are included, both parent and child elements• The columns are narrowed to fit the

	<p>page width (if necessary)</p> <ul style="list-style-type: none"> • The indicator icons are not printed • The font size and type face are uniform across the report <p>To generate the print-out:</p> <ol style="list-style-type: none"> 1. Click on the 'Specification - Specify > Element > Documentation > Generate Documentation (RTF/PDF/DOCX)' ribbon option. On the 'Generate Documentation' dialog, the 'Template' field defaults to 'Specification Manager List'. 2. If necessary, specify the output file location and extension, then click on the Generate button. 3. Display and print the output file.
<p>Generate reports</p>	<p>If you should need to extract and/or publish more of the information in the Specification Manager, you can do so in a range of forms such as:</p> <ul style="list-style-type: none"> • Using other templates and generation options to produce standard or customized document reports in RTF, DOCX or PDF format • Publishing on the web in HTML or Joomla!, or • Exporting to a spreadsheet tool in CSV

	format
--	--------

Notes

- As you work on the information on the Specification Manager, periodically press F5 to refresh the view to include any updates performed by other users elsewhere in the system
- In the Corporate and extended editions of Enterprise Architect, User Security can be applied to restrict or enable access to a range of operations and functions; if you cannot access a function in the Specification Manager, check with your System Administrator or Security Administrator to see if you have access permissions to work with that function

Specification Manager Configuration

As you work with the Specification Manager, you can tailor the display to provide more precise information, and to better represent the information. The Specification Manager provides options to:

- Create reference data to work from
- Modify the appearance of the entries, including the amount of Notes text to show
- Apply level numbering and automatic element naming and numbering

Appearance Options

It is possible to tailor the appearance of the Specification Manager view to better display the information you want to examine.

Access

Ribbon	<p>Specification - Specify > Display > Notes Format > [format option]</p> <p>Specification - Specify > Display > Bold Names</p> <p>Specification - Specify > Display > Collapsible Regions</p> <p>Specification - Specify > Display > Highlight Selection</p> <p>Specification - Specify > Display > Font Size > [size option]</p> <p>Specification - Specify > Display > Element Icon</p>
---------------	--

Adjust the appearance of the display

Aspect	Description

Display of Notes

In the Specification Manager you can choose to hide, check, or create and edit Notes text on the screen.

Click on the 'Notes Format' icon and one of these options:

- 'Hide' to not show the Notes at all; the element rows close up
- 'Preview' to show the first line (the width of the 'Item' column) of Notes text for each element; in this mode, you cannot edit the Notes text in the Specification Manager, only in the Notes window
- 'Full Notes Inlined' to show the complete Notes text for each element underneath the element name; in this mode you can create, edit and delete Notes text in the Specification Manager and perform the same operations as are available in the Notes window context menu
- 'Full Notes in Column' to show the complete Notes text for each element in a new column next to the element names; you have the same freedom to edit the text as for 'Full Notes Inline'
- 'Document View' to show the element names and text only, with no column headings or properties

<p>Display element names in bold</p>	<p>Select the 'Bold Names' checkbox. All element names, including the names of child elements, are displayed in bold.</p>
<p>Enable the use of Expansion arrows on parent elements</p>	<p>If an element has child elements, you can configure the Specification Manager to either:</p> <ul style="list-style-type: none">• Hide the child elements but provide an expansion arrow that you can click on to open and collapse the element hierarchy (select the 'Collapsible Regions' checkbox), or• Automatically display the child elements indented underneath the parent element (deselect the 'Allow Collapsible Regions' checkbox)
<p>Highlight the current element details</p>	<p>When you click on an element name or property, the Specification Manager defaults to indicating the selection with side bars and/or underlines. You can, if you prefer, also highlight the entire row of data for the element, by selecting the 'Highlight Selection' checkbox.</p>
<p>Show Element</p>	<p>The Package you are reviewing might contain elements of a number of different</p>

Type as Icon	types, so it is helpful to be able to see at a glance the type of the element you are reviewing. Select the 'Element Icon' checkbox to display an icon representing the element type, to the left of each element name.
Change Font Sizes of display	<p>Across the Specification Manager view, the various display components such as parent element names, child element names, Notes/property values and column headings each have their own font size. You can select to increase or decrease the font sizes as a set across the display, relative to the current sizes.</p> <p>Select the 'Font Size' option and either:</p> <ul style="list-style-type: none">• 'Small'• 'Medium' or• 'Large'

Model Options

The Specification Manager helps you to develop the elements in a Package from 'the ground up'. You use standard, or reference, data in doing this, such as the names of team members who can create and edit model data, or the automatic naming system to apply in creating your elements. Because you can start from an early stage in the model's development, some of the reference data you want to use might not exist. The Specification Manager makes it easier to keep the elements in focus and check the development of properties as you use the facilities for defining the types of data you need.

Access

Ribbon	Design > Dictionary > Glossary > Glossary View Settings > Reference Data > Model Types > General Types > Requirement Settings > Reference Data > Model Types > People > Project Authors Settings > Reference Data > Settings > Auto Names and Counters Settings > Reference Data > UML Types > Tagged Value Types
--------	---

Configure data for development

Data Type/Option	Description
Project Glossary	It is possible to create a Glossary of terms and definitions used throughout the Project, and to automatically link to the definition of a term where it occurs in the model text.
Requirement Types	Requirement elements can be of one of several system-defined types, as shown in the 'Stereotype' column of the Specification Manager, if you have selected to work on Requirements. If these types are not sufficient for your needs, you can define alternatives on the 'Requirement' page of the 'General Types' dialog.
Project Authors	A Project Author is a system user who has responsibility for creating modeling structures and data in a project. Initially there are no Project Authors defined on the system, and you might need to identify the users who are in your

	<p>development team.</p> <p>Click on the 'Settings > Reference Data > Model Types > People > Project Authors' ribbon option to display the 'People' dialog, on which you define the Project Authors.</p>
Auto Names and Counters	<p>When you start to create elements in your model, the system automatically gives them a name based on the element type and the number of elements of that type that already exist. For example, if you create a series of Requirement elements the default names are 'Requirement1', 'Requirement2', 'Requirement3' and so on. You then edit these default names.</p> <p>Alternatively, you can define your own default naming and numbering system for specific element types, for either the element name, the element alias, or both. Display the 'Auto Name Counters' dialog, with which you can define your naming and numbering system.</p>
Extended Property Types	<p>You can add Extended Properties (Tagged Values) to the elements in the Specification Manager, using the 'Extended Properties' option on the element content menu.</p>

However, you might want to use a type of Tagged Value that is not currently available; in this case, you can create that type using the 'Tagged Value Types' page of the 'UML Types' dialog.

Click on the 'Settings > Reference Data > UML Types > Tagged Value Types' ribbon option to display the 'UML Types' dialog.

Notes

- In the Corporate and extended editions of Enterprise Architect, a User Security system can be applied that restricts or enables access to a range of operations and functions; if you cannot access a function in the Specification Manager, check with your System Administrator or Security Administrator to see if you have access permissions to work with that function

Package Options

As you define the elements in your specification you can make them easier to reference by giving them more appropriate element names and/or numbers, either as the elements are created or retrospectively when a naming and numbering system has been finalized. You can also make the elements easier to locate and view by enabling level-numbering and indenting, helping you to organize and review the sequence and arrangement of the elements in the Specification Package. If you have been exploring other areas of the Browser window, you can return focus to the Specification Package in the Browser window.

Access

Ribbon	Design > Package > Manage > Options > Level Numbering Specification-Specify > Element > Apply Auto Naming Specification-Specify > Display > Level Numbering > Enable Specification-Specify > Display > Level Numbering > Indent Description
--------	--

Configure Package options

Option	Description
Apply Auto Naming to Elements	<p>If you had to create elements before setting up an auto-naming and/or auto-numbering system, you can select this option to apply the system to the existing elements retrospectively.</p> <p>If you set up an auto-naming and/or auto-numbering system before creating your elements, that system is automatically applied as you create the elements.</p>
Level Numbering - Enable	<p>Click on this option to apply level numbering to the elements in the Specification Package and indent each successive level, both in the Specification Manager and in the Browser window. Nested elements are numbered hierarchically; that is:</p> <ul style="list-style-type: none"> 1 Name 2 Name <ul style="list-style-type: none"> 2.1 Name <ul style="list-style-type: none"> 2.1.1 Name 2.1.2 Name

	3
Level Numbering - Indent Description	<p>If you have enabled level numbering, this option is available to indent the element description under each element name, to align with the element name. If the option is not selected, the text is aligned with the left-hand edge of the level number. For example:</p> <p><i>Option ON:</i></p> <ul style="list-style-type: none">1 Name Description2 Name Description<ul style="list-style-type: none">2.1 Name Description<ul style="list-style-type: none">2.1.1 Name Description2.1.2 Name Description3 Name Description <p><i>Option OFF:</i></p> <ul style="list-style-type: none">1 Name Description

	<p>2 Name</p> <p>Description</p> <p>2.1 Name</p> <p>Description</p> <p>2.1.1 Name</p> <p>Description</p> <p>2.1.2 Name</p> <p>Description</p> <p>3 Name</p> <p>Description</p>
--	--

Notes

- In the Corporate and extended editions of Enterprise Architect, a User Security system can be applied that restricts or enables access to a range of operations and functions; if you cannot access a function in the Specification Manager, check with your System Administrator or Security Administrator to see if you have access permissions to work with that function

Select Specification Type

When you start to use the Specification Manager you can work on elements of all types in the Package (the default) or identify a specific type of element to work on. You can select any type of element supported by Enterprise Architect or the MDG Technologies that are integrated with the system.

If you specify the element type first, when you go on to locate the Package to work in, the system automatically filters for Packages that already contain that type of element.

Access

Ribbon	Specification-Specify > Element > Element Type Specification-Specify > Element > Element Type > Limit Display to Selected Type
--------	---

Select the element type

Click on either:

- 'Other', and expand the technologies and element groups until you can click on a specific element type to filter for, or

- An element type from the list of recently used types (if you have not previously selected a specific element, or you have cleared the list, this list is not available)

Also check that the 'Limit Display to Selected Type' option is selected.

To revert to listing any type of element in the Package, click on either the:

- '<Any>' option or
- 'Limit Display to Selected Type' option again to deselect it

The list of recently used types (after the 'Other' option) accumulates entries as you focus on elements of different specific types. This helps you cycle through work on elements of a small group of types.

If the list is no longer relevant to your work (for example, you have moved on to a different module or stage of development) you can clear the list by selecting the 'Clear Recent Items' option, and start to accumulate a different set of frequently used element types.

Select Specification Package

When you start to work with the Specification Manager, you identify the Package in which to build your specification.

When you open the facility, the Specification Package defaults to the first top-level Package in your model, as indicated by the 'Package path' in the Navigator toolbar. If this is the Package in which you intend to work, you can go on to configure the display and create or review elements.

You might, however, want to use a different Package that:

- Already exists in the model and already contains elements of the specified type
- Already exists in the model but contains no elements of the specified type
- You will create underneath the current Specification Package, or
- You will create underneath a different Package elsewhere in the model

You can perform these tasks using the 'native' facilities of the Navigator Toolbar.

Access

Click on a Package in the Browser window, then use one of these options to open the Package in the Specification Manager.

Ribbon	Design > Package > Specification View
--------	---------------------------------------

Context Menu	Right-click on Package Specification Manager
Keyboard Shortcuts	Ctrl+0

Locate Existing Package Containing Specification Elements

Step	Action
1	<p>In the Navigation toolbar, right-click on the name of a Package in the Package path, and select the 'Go to Package' option.</p> <p>The 'Select a Specification Package' dialog displays. This dialog presents your model hierarchy, filtered to show only those Packages that already contain elements of the type you selected as the Specification element type (which is identified in the 'Element Type' field at the top of the dialog).</p>
2	<p>To expand a Package and reveal sub-Packages it contains, click on the expansion arrow next to the Package name, or click on the Expand All button. (If a Package does not contain any sub-Packages, it has</p>

	no expansion arrow.)
3	<p>Click on the required Package, and click on the OK button.</p> <p>The Package name displays in the 'breadcrumb trail' in the toolbar, and the elements in the Package are shown in the main body of the Specification Manager window, filtered to the specified type if appropriate.</p>
4	<p>Customize the columns and/or add elements to the Package.</p>

Locate Existing Package

It is possible that you want to create your specification in a Package that has been set up for this purpose but does not yet contain any elements (or any elements of the specified type). In this case the Package would not be included in the 'Select a Specification Package' dialog. To select this Package for the Specification Manager:

- Right-click on the Package name in the Browser window and select 'Specification Manager' from the context menu, or
- Select the Package in the Browser window, then press Ctrl+0, or
- Click on the Package name and on the 'Design > Package

> Specification View' ribbon option

The Package name displays in the view header and Toolbar.

Create New Package

This method creates a new Package underneath the current Specification Package.

Step	Action
1	From the ribbon bar, select 'Specification-Specify > Specification > Package > New'. The 'New Package' dialog displays.
2	In the 'Name' field, type the name of the new Package. (Optionally, you can also select a radio button to automatically create a new diagram in the Package.)
3	Click on the OK button. The new Package becomes the current Specification Package in the Navigator toolbar. The Package is also added to the Browser window, underneath the previous Specification Package.
4	Customize the columns and/or add elements to the Package.

Create New Package Elsewhere in the Model

This method creates a new Package underneath a different Package in the model.

Step	Action
1	From the ribbon bar, select 'Specification-Specify > Specification > Package > New'. The 'New Package' dialog displays.
2	Click on the Browse button beside the 'Owner' field. The 'Select Owner' dialog displays.
3	Browse through the model and click on the existing Package under which to create the new Package. Click on the OK button. The 'Owner' field in the 'New Package' dialog is updated.
4	In the 'Name' field, type the name of the new Package. Optionally, you can also select a radio button to automatically create a new diagram in the Package.
5	Click on the OK button. The new Package becomes the current Specification

	Package, named in the window toolbar. The Package is also added to the Browser window underneath the selected parent Package.
6	Customize the columns and/or add elements to the Package.

Customize Columns

The Specification Manager can display a wide range of properties for the elements in the selected Specification Package, each property being shown in a separate column. Using the 'Field Chooser' dialog, you can customize the display of the columns so that you show as many or as few as you need, in an appropriate sequence. Also, you can add columns to show the values of specific tags used in individual elements or globally across the Package.

Having added the columns you need, you can use full or partial property values in the Filter bar as a means of filtering the display to show only those elements that have property values that match the filters.

Access

Ribbon	Specification - Specify > Display > Show Columns Specification - Specify > Display > Filter Bar
Other	Right-click column headings Field Chooser Right-click column headings Toggle Filter Bar

Using the Field Chooser

Drag the column headings that you want to include out of the 'Field Chooser' and onto the header bar, in the position you want the column to occupy in the sequence of column headings. You can drag an existing heading from its current position in the bar to another position in the sequence, including making it the final column.

If you do not want to include a column that is already in the heading bar, drag it up or down out of the bar. It is automatically returned to the 'Field Chooser' dialog.

Using the Filter bar

In the Filter bar, you define a text string that any displayed values in the corresponding column must include.

In the filter field for a column, type the character or string that must form part of the value shown in each row of that column. As you type the string, element rows in the Specification Manager that do not match the filter are hidden from display.

To clear the text in the filter field, click on the green cross at the right of the field.

You can display or hide the Filter bar by right-clicking on the column headings and selecting the 'Toggle Filter Bar' option.

Add Tagged Value Column

If you want to show the value that any element in the list has for a particular tag, you can add a column specifically for that tag. There are two ways in which to do this:

Method	Action
1	<p>Open the 'Tags' tab of the 'Properties' dialog for the element (Alt+5 Properties Dialog > General > Tags) and drag the tag onto the Specification Manager; a new column is added for each tag you drag onto the list.</p>
2	<p>Either:</p> <ul style="list-style-type: none">• Right-click on the element in the Specification Manager and select the 'Add Tag Value Column' option, or• Right-click on the column headings and select the 'Add Tag Value Column' option, or• Select the 'Specification - Specify > Display > Tagged Value Column' option <p>The 'Add Tag Value Column' dialog displays.</p> <p>Either type the tag name into the 'Tagged Value' field, or select one of the two radio</p>

buttons:

- Global Tagged Values - populates the 'Tagged Value' drop-down list with all global Tagged Values in the project; you can select a Tagged Value that is applicable to a large number of elements
- Tagged Values from the selected element - populates the 'Tagged Value' drop-down list with the Tagged Values defined for the selected element (as listed on the 'Tags' tab for that element); select the Tagged Value from this filtered list of tags

When you have selected the required tag, click on the OK button to add a column for that tag to the Specification Manager columns.

Notes

- You can edit the values of the tags in the Tagged Value columns; see the *Editing Elements* Help topic
- The column layout for any added Tagged Value columns is preserved when you close the Specification Manager and re-open it for the same Package
- You can hide a Tagged Value column by dragging the

column title off the header bar - as for any other column - so that the column header is added to the 'Field Chooser' dialog

- You can remove a Tagged Value column altogether by right-clicking on the column header and selecting the 'Remove Tag Value Column' option

Adding Elements

The Specification Manager is an excellent model development tool, through which you can create elements in the Package you are reviewing in a number of ways. You can add new elements either:

- Directly to the Package or
- As child elements of an element in the Package

There are several methods of adding a new element, some of which vary depending on whether you have set a specific element type as the Specification Type, or set the display to list all types of element in the Package. If you import a set of element data from an external spreadsheet (.csv) file, this setting will also filter the imported information to show elements of the specified type or all types.

Access

With the Specification Manager window open:

Diagram Toolbox	Drag an element icon from an appropriate page of the Diagram Toolbox onto the Specification Manager
Ribbon	Specification-Specify > Element > Insert > Add Default Specification-Specify > Element > Insert > Add Child

	<p>Specification-Specify > Element > Insert > Repeat Previous</p> <p>Specification-Specify > Element > Insert > Add Other</p> <p>Specification-Specify > Element > Insert > Add Multiple Elements</p>
Context Menu	<p>Right-click window Add New Element</p> <p>Right-click window Add New Child</p> <p>Right-click window Repeat last Element</p> <p>Right-click window Create Multiple Elements</p>
Add New Button	Click on the Add New button at the end of the display
Keyboard Shortcuts	<p>Ctrl+N (new element)</p> <p>Ctrl+Shift+N (new child element)</p> <p>Shift+F3 (repeat previous element)</p>

Add an element from the Diagram Toolbox

When you have the appropriate page of the Diagram Toolbox displayed (press Ctrl+Shift+3), click on  and use the Toolbox 'Find Toolbox Item' dialog to locate the page), you can drag an element icon to a specific point on the Specification Manager View. The element entry

immediately above the cursor is indicated by a blue side-bar, and a context menu displays with three options:

- 'Insert after Selection' - the new element will be added as a peer immediately underneath the highlighted element
- 'Insert as Child' - the new element will be added as a child of the highlighted element
- 'Add to End of Document' - the new element will be added to the end of the list, as a peer of the highest level of the hierarchy

Add element using the Add New button

At the bottom of the Specification Manager view, this button displays:



Select a current element, then click on the button or use the keyboard down-arrow to move to and select it, then select either:

- An element type from the list of appropriate types based on the current Package type and content
- The 'Other' option and select an element group and type from the submenu, or
- The 'Any' option to display the 'New Element' dialog, from which you can select an element type from any defined in the model

The new element is added to the Package immediately after and at the same level as the selected element.

The button can be hidden and redisplayed using the 'Add New Button' option on the 'Display' panel of the Specification - Specify ribbon.

Add element of predefined Specification Type

If you have set the Specification Type to a particular type of element:

- An element of that type is immediately added to the Specification Manager; the element has either the system default element name or a name that you have set up under your own naming conventions
- The name is highlighted and, if you want to change it, you can immediately type in an alternative name
- If the element is a child of an existing element, the entry is added underneath the parent, indented and in a smaller font; the parent element is given an expansion arrow

Add element of any Specification Type

If the Specification Manager is listing elements of any type, or if you have set the 'Specification Type' to '<Any>', the 'New Element' dialog displays. You can use this dialog to create an element of any type that the model supports.

Add elements from Pattern

Enterprise Architect provides Patterns in the Diagram Toolbox and in the 'Resources' tab of the Browser window; you can create your own Patterns and make them available from the same places. Patterns are a great way to create template structures of elements in your specifications, and you can 'drag and drop' them from the Toolbox or 'Resources' tab of the Browser window into the Specification Manager.

When you release the mouse button to 'drop' the Pattern, a short menu displays from which you select to add the Pattern elements underneath the item immediately above, either as a peer structure or as a child structure.

Notes

- If you add an element of the defined Specification Type to the selected Package in the Browser window, it is also added to the Specification Manager
- In the Corporate and extended editions of Enterprise Architect, User Security can be applied that restricts or enables access to a range of operations and functions; if you cannot access a function in the Specification Manager, check with your System Administrator or Security Administrator to see if you have access permissions to work with that function

Deleting Elements

The Specification Manager provides a direct view of a Package in your model, and reflects the contents of the Package as it appears in the Browser window. If you delete an element from the Specification Manager, it is removed from the model and therefore also disappears from the Browser window. Any child objects that the element has are also deleted from the model.

Access

Context Menu	Right-click on element Delete Selected
Keyboard Shortcuts	Ctrl+D Ctrl+Del

Delete an element

When you select to delete an element in the Specification Manager, a prompt displays to confirm that you want to delete the element from the model.

Click on the Yes button. The element is removed from the Specification Manager and all other windows and diagrams in which it appears.

Notes

- You cannot select more than one separate element at a time in the Specification Manager, and therefore you cannot delete multiple elements there; you can, however, select and delete multiple elements from the Browser window, which also removes them all from the Specification Manager in one operation
- In the Corporate and extended editions of Enterprise Architect, a User Security system can be applied that restricts or enables access to a range of operations and functions; if you cannot access a function in the Specification Manager, check with your System Administrator or Security Administrator to see if you have access permissions to work with that function

Editing Elements

When you have created elements in the Specification Manager, you can add and review the properties and characteristics of each element to whatever extent you need. You could simply set some basic properties such as the element version, status and general description in the Notes area, or you could develop extended properties (Tagged Values) or add a Linked Document to add more detailed and extensive information on the element.

Editing tasks

Task	Action
Display/Edit Element Properties	<p>Where a column in the Specification Manager contains a property value, you can double-click on the value and either:</p> <ul style="list-style-type: none"> • Type a different value (such as the element name) or • Click on the field to display a drop-down arrow and select a value from the list <p>Alternatively, click on the value and press F2.</p> <p>Otherwise, you can right-click on the item and select the:</p> <ul style="list-style-type: none"> • 'Properties' menu option (or press

	<p>Alt+Enter) to display the 'Properties' dialog, or</p> <ul style="list-style-type: none">• 'Properties window' menu option (or press Ctrl+2) to display the Properties window
Edit Element Notes	<p>The 'Specification - Specify' ribbon provides the 'Notes Format' icon for defining how you view existing Notes text on each element, or how you create and edit Notes, depending on how you have configured the display of Notes on the screen.</p> <p>If you select the 'Preview' option, the first line of any Notes text in the Notes window displays underneath the element name. You cannot add or edit text in this space, but you can work on the text in the Notes window itself (click on the text and press the Space bar).</p> <p>If you select a 'Full Notes' option, either inline or in column, the complete text of any existing Notes displays underneath or to the right of the element name, respectively. You can now create and edit the Notes directly in the field - simply click twice on the area and type in the text. The text you type here can also be viewed in the Notes window; text edits in</p>

one of the views (Notes window or Specification Manager) are updated in the other view as soon as you click off the item.

In either view, you can also right-click on a text string to display the 'Notes' context menu and perform further operations, and use keyboard shortcuts. These operations include:

- Creating a Glossary definition from the text, and linking to existing definitions in the text
- Generating a new element in the same Package, with the selected text as the name and linked to the text
- Generating a new element linked to the text, that you effectively drag directly onto an open diagram
- Creating a link from the selected text to an existing element in the model (in the Notes window only)
- Creating a hyperlink to a wide range of target objects, including image files, diagram images, web pages, text files, Help topics and Enterprise Architect commands (Notes in the Specification Manager, or using the 'Hyperlink' icon in the Notes window toolbar)
- Mark the text for a specific translation,

	<p>or for excluding from automatic translation</p> <ul style="list-style-type: none"> • Searching for instances of the selected text in a range of sources (options derived from the 'Code Editor' context menu) • Editing the text, with cut, copy, paste, undo and delete • Hiding or revealing Glossary definition markers (underlines) in the text (Specification Manager Editing Notes row) <p>You can also select to display only the element names and notes in the Specification Manager (Document View) or to hide the Notes text altogether, in which case the element rows close up.</p>
<p>Locate a selected element in the Browser window</p>	<p>Right-click on the element item and select the 'Find in Project Browser' option (or click on the item and press Ctrl+F). The system expands the Browser window and highlights the element name.</p>
<p>Review extended properties (Tagged Values) on an</p>	<p>Right-click on the element item and select the 'Tagged Values' option (or click on the item and press Ctrl+2). The Properties window displays; select the 'Tags' tab, through which you can</p>

<p>element</p>	<p>view, add, edit and delete Tagged Values on the selected element.</p> <p>Once the Properties window is open, you can click on any element in the Specification Manager and immediately switch the focus of the 'Tags' tab to that element.</p> <p>You can also show the values for specific tags used in the Package, with a Tagged Values column for each named tag. See <i>Customize Columns</i>. If an element has a Tagged Value that matches the column header, you can edit the value. For:</p> <ul style="list-style-type: none"> • Values selected from a defined list, double-click on the value and change it in the 'Tags' tab • Free-text values, whether simple or <memo> type, click twice on the value and edit it in place <p>The field is not editable if the element does not have the tag, is locked or has duplicate tag names.</p>
<p>Create and edit a Linked Document on an element</p>	<p>You can create a Linked Document on the selected element in the Specification Package, by:</p> <ul style="list-style-type: none"> • Right-clicking on the element line and selecting the 'Linked Document' option,

	<p>or</p> <ul style="list-style-type: none">• Clicking on the element line and pressing Ctrl+Alt+D <p>The 'New Linked Document From Template' dialog displays, from which you select any template you want to base the document on, or 'None' for a free-style document with no template.</p> <p>When you click on the OK button, the 'Linked Document Editor' view becomes active, with the 'Document - Edit' ribbon, and you can create a document describing any aspect of the selected element.</p> <p>If the element already has a Linked Document, selecting the 'Linked Document' option opens that document.</p> <p>If you no longer want the Linked Document, select the 'Start > Application > Design > Document' ribbon option and, on the 'Linked Document' tab of the Document window, click on the  icon and select the 'Delete Linked Document' option.</p>
Finishing and Saving your changes	A quick way to save your changes and exit from the item editor is to press Esc.

Notes

- You can also copy-and-paste text from a text file into the Specification Manager, using the text to fill the element name or notes text area of an existing element entry
- In the Corporate and extended editions of Enterprise Architect, a User Security system can be applied that restricts or enables access to a range of operations and functions; if you cannot access a function in the Specification Manager, check with your System Administrator or Security Administrator to see if you have access permissions to work with that function





Indicator Columns



An element specification can have any of a number of resources associated with it. You can obtain a quick indication that resources exist for the element by displaying the corresponding column (selected from the 'Field Chooser' dialog) on the Specification Manager; if the resource exists, an icon displays in the column against that element. When an indicator is displayed, you can double-click on the icon to immediately access the record or the first in a set of records for the element, in the corresponding window. You can use these windows to edit, delete or (where appropriate) add to the records against the element.

The Package you are reviewing might also contain elements of a number of different types, so it is helpful to be able to see at a glance what the type is of the element you are reviewing. In the 'Specification - Specify > Display' ribbon panel, select the 'Element Icon' checkbox to display an icon representing the element type, to the left of each element name.

Columns

Column Header	Indicator
Relationship	 Indicates that: The selected element has

	at least one relationship to another element, which is shown in the Traceability window.
Resource	 <p>Indicates that: There is at least one resource assigned to a task on the element, in the Resource Allocation window.</p>
Risk	 <p>Indicates that...: There is at least one Risk item defined for the element, in the Risk window.</p>
Maintenance	 <p>Indicates that...: There is at least one Maintenance item defined for the element, in the Maintenance window.</p>
Test	 <p>Indicates that...: There is at least one Test item defined for the element, in the Test Cases window.</p>
File	 <p>Indicates that...: The selected element has at least one associated file, defined on the 'Files' page of the Properties window.</p>

Discussion	 Indicates that...: There is a discussion thread or review of this element, in the Discuss & Review window.
Journal	 Indicates that...: There is a Journal entry for this element, in the Discuss & Review window under the Journal tab.
Document	 Indicates that...: There is a Linked Document for this element.
All Indicators	- Indicates that...: Any or all of the listed items exist for the element, as indicated by the corresponding icon.

Traceability

As you create and set up the elements in your Specification Package, using the Specification Manager, it is critical to:

- Trace any existing relationships those elements have to the elements in the model that realize them, or are realized by them
- Follow the relationships of such elements further, to check how changes to a source element or its relationships might affect other relationship chains in which the target elements are involved
- Create new relationships, where you can do so quickly and with an immediate view of how elements as a group are connected across the model

The two most significant tools for this are the Traceability window and the Relationship Matrix.

When you display the Traceability window, you can review every relationship in which the element selected in the Specification Manager is the source or target, the details of each of the related elements, and the relationships in which each of those elements are involved.

In the context of the Specification Manager, the Relationship Matrix provides a view of the relationships between the elements within the Specification Package, or between the elements of the Specification Package and a different Package. You can also use it to quickly create many relationships between the elements, defining a simple organization within the Specification Package and defining

its relationships with other Packages.

Access

Ribbon	'Design > Package > Specification View > In Navigation toolbar, right-click on final Package in the Package pathway > Open Relationship Matrix > <options> Design > Element > Trace
Keyboard Shortcuts	Ctrl+7 (display Traceability window)

Open Relationship Matrix

If you want to quickly create relationships on the elements in your Specification Package, or review the relationships that already exist, you can do so very easily using the Relationship Matrix. By opening the Relationship Matrix from within the Specification Manager, you can use the parameters already set in the Specification Manager to automatically configure the Relationship Matrix.

Access

Ribbon	Design > Package > Specification View > In Navigation toolbar, right-click on the Package name > Open Relationship Matrix > <options>
--------	---

Open the Relationship Matrix

Option	Action
As Source	Open the Relationship Matrix with the Specification Package set as the Source Package and the Specification Type element type as the Source element type.

	Other fields default from the last settings of the Relationship Matrix; you can change any fields as necessary.
As Target	Open the Relationship Matrix with the Specification Package set as the Target Package and the Specification Type element type as the Target element type. Other fields default from the last settings of the Relationship Matrix; you can change any fields as necessary.
As Both	Open the Relationship Matrix with the Specification Package set as both the Source Package and the Target Package, and the Specification Type element type as the Source and Target element type. Other fields default from the last settings of the Relationship Matrix; you can change any fields as necessary.
Matrix Profiles > Create New Profile	Define a Matrix profile with the Specification Package set as the Source Package and the Specification element type set as the Source element type, and automatically open the Relationship Matrix with this profile in effect.
Previous	Open the Relationship Matrix using the

Settings	<p>previously-processed settings; that is, the last settings under which changes were saved to the repository.</p> <p>These settings could have been defined during your use of the Specification Manager, or in the Relationship Matrix independent of any use of the Specification Manager.</p>
----------	---

Notes

- In the Corporate and extended editions of Enterprise Architect, a User Security system can be applied that restricts or enables access to a range of operations and functions; if you cannot access a function in the Specification Manager, check with your System Administrator or Security Administrator to see if you have access permissions to work with that function

Create Matrix Profile



In using the Specification Manager you work on a specific Package and element type. If you want to use a Relationship Matrix profile to look more closely at the relationships of elements in that Package, it is therefore more logical to define the profile from the information already set in the Specification Manager, before you open the Relationship Matrix. The system helps you to do this. You can also apply this procedure to creating the matrix profile represented by a Matrix Specification Artifact element.

Access

Ribbon	'Design > Package > Specification View > In Navigation toolbar, click on final ▶ > Matrix Profiles > Create New Profile
--------	---

Create the Matrix Profile

Option	Action
Profile	Type in a name to identify the profile.
Source	Displays the name of the current

	<p>Specification Package, as the source Package in the Relationship Matrix.</p> <p>If necessary, you can click on the  button and select a different Package.</p>
Type	<p>(For the Source Package) Displays the name of the current Specification element type. If necessary, you can click on the drop-down arrow and select a different element type.</p>
Target	<p>Defaults to the name of the current Specification Package as the target Package of elements in the relationships to examine.</p> <p>If you want to examine relationships to elements in a different target Package, click on the  button and, on the 'Browse Project' dialog, locate and select that Package.</p> <p>Click on the OK button to put the Package name in the 'Target' field.</p>
Type	<p>(For the Target Package) Defaults to '<All>' target element types.</p> <p>If you want to examine relationships to a specific type of element, click on the drop down arrow and click on the element type name.</p>

Relationship	<p>Defaults to 'Realization' as the type of relationship to display.</p> <p>If you want to examine relationships of a different type, click on the drop down arrow and click on the relationship type name.</p>
Direction	<p>Defaults to 'Source -> Target' as the direction of the relationships to examine.</p> <p>If you want to examine relationships in the opposite direction, or in both directions, click on the drop-down arrow and select the appropriate option.</p>
OK	<p>Click on this button to create the profile and close the dialog.</p> <p>The Relationship Matrix automatically opens, applying the Profile that you have just defined.</p>
Cancel	<p>Click on this button to discard any values you have entered, and to return to the Specification Manager.</p>

Notes

- After you have created a Matrix profile, the name of the profile is added to a list of profiles that include the Specification Package and Specification element type, under the 'Create new Profile' option; when you click on the profile name, the Relationship Matrix immediately displays with that profile in effect
- In the Corporate and extended editions of Enterprise Architect, a User Security system can be applied that restricts or enables access to a range of operations and functions; if you cannot access a function in the Specification Manager, check with your System Administrator or Security Administrator to see if you have access permissions to work with that function

Reviewing Elements

When you are managing or working as a member of a project team, it is useful to have mechanisms for reviewing the work you are doing and keeping some record of those reviews, whether they are casual discussions between peers or coordinated, structured and formal reviews. The Specification Manager supports the full range of review types, focused on the elements that are defined in the Specification Package.

Access

Ribbon	Design > Package > Specification View > click on required Package or element
--------	--

Review facilities

Facility	Description
Review Documents	It is possible to create any number of 'Review Documents' on the elements of the Specification Package, both to formalize and guide specific review processes and to present the element

	<p>information to be reviewed.</p> <p>The documents are stored in and easily accessed from the 'Model Library' feature. Select the 'Start > Collaborate > Model Library' ribbon option.</p>
Bind Package to Model Library Folder	<p>By default, 'Review Documents' are stored in folders under a special category of the Model Library, called 'Formal Reviews'. You can, however, generate those documents elsewhere in the Model Library, by binding the Specification Package to whichever Model Library folder (topic) is most appropriate to the Package.</p>
Model Library	<p>The Model Library tools provide a number of other facilities that can be of use in discussing the development and features of an element, such as the 'Resources' folder or the ability to develop a sequence of communications on a specific element, on a group of elements, or on some broader aspect of the model development.</p>
Discussions	<p>Using the Discuss & Review window, you can initiate or respond to a general, ad-hoc discussion amongst your team</p>

	<p>members, on a specific element. The facility maintains a record of each initial comment or question, and every response to that comment.</p> <p>There is no limit on the number of different discussions, on the number of responses, or on the length of each item, although the facility is better suited to short queries and responses.</p> <p>Similarly, you can perform a formal review on one element or a group, adhering to a stricter protocol and timeframe.</p> <p>When there is a discussion or a review on an element, the  icon displays in the 'Discussion' and 'All Indicators' columns on the Specification Manager. Simply double-click on the icon to display the discussion or review comments.</p>
Model Mail	<p>The Model Mail facility is a personal, project-internal email service. You can use it to send emails to specific individuals or groups on your project, concerning the Specification Manager contents or functions, or any other subject you need to discuss.</p> <p>If you want to discuss a particular element, click on it in the Specification</p>

	<p>Manager, open Model Mail (right-click Collaborate Send Mail) and create a message, and use the 'Insert Quicklink' button to create a hyperlink in the mail message to the selected element.</p>
--	--

Create Review Document

When you are managing the work of a project team, it is useful to have a mechanism for coordinating and guiding the work that the team members are required to do on the elements in the Specification Package, such as a review document. You can generate this type of document quickly and simply from the Specification Manager, to be distributed, accessed and read through the Model Library facility.

There are, broadly, two types of review document that you can generate:

- A specification document that contains the material to be reviewed - the individual features of each element - such as a Model Overview, List of Issues or Maintenance Report, and
- A management or review document that guides the reader in applying tests, checks and procedures across the Package, such a Phase Review, Test Plan or Training Plan

You can generate both kinds of document using a range of templates, or create a document without using any template. The templates are all those available through the Report Generator (specification documents) or Linked Document Editor (management documents), whether system-provided or user-designed.

The specification documents automatically structure information from the Specification Manager according to the selected template and should not require further editing

to serve their purpose (although it is possible to edit them if you need to). They are therefore termed 'auto-generated documents'.

By default, 'Review Documents' are stored in folders (Topics) in a special category of the Model Library, called 'Formal Reviews'. You can, however, generate those documents elsewhere in the Model Library, by binding the Specification Package to whichever Model Library folder is most appropriate to the Package. For example, if you have a modular structure in the Model Library, you might want to hold the 'Review Documents' for a Specification Package in the same section of the Model Library as folders containing discussions and documents on the part of the model containing that Package.

Access

Ribbon	Start > Collaborate > Model Library
--------	-------------------------------------

Create a Review Document

Option	Action
Name	On the 'Team Document' dialog, type a name for the document.

	<p>This is the name that you use to recognize and open the document in the Model Library folders.</p>
RTF Template	<p>Click on the drop-down arrow and select either:</p> <ul style="list-style-type: none">• 'None' to create a free-format document yourself, or• A document template name, to create a document of that type
OK	<p>Click on this button to open the document in the 'Document Editor', which you can use to populate the document with text and images, format it and print it.</p> <p>At the same time:</p> <ul style="list-style-type: none">• The Library window opens• The 'Formal Reviews' category is created (if it does not already exist) in the Model Library• A folder is created with the same name as the Specification Package (if it does not already exist) in the 'Formal Reviews' category• The review document name is added to this folder <p>If you have bound the Package to a different Model Library folder, the</p>

	'Review Document' is created in that folder instead of under the 'Formal Reviews' category.
--	---

Auto-generate a Review Document

Option	Action
Name	<p>On the 'Team Document' dialog, type a name for the document.</p> <p>This is the name that you use to recognize and open the document in the Model Library folders.</p>
RTF Template	<p>Click on the drop-down arrow and select a document report system-template name, to create a document of that type</p>
OK	<p>Click on this button to generate the document through the Document Report Generator, containing the information currently displayed in the Specification Manager, within the parameters of the report template.</p> <p>At the same time:</p> <ul style="list-style-type: none"> • The Library window opens

	<ul style="list-style-type: none">• The 'Formal Reviews' category is created (if it does not already exist) in the Model Library• A folder is created with the same name as the Specification Package (if it does not already exist) in the 'Formal Reviews' category• The review document name is added to this folder <p>The document is displayed in the 'Team Document' tab for any further editing and modification you need, although the document is effectively ready for immediate use.</p> <p>If you have bound the Package to a different Model Library folder, the 'Team Document' is created in that folder instead of under the 'Formal Reviews' category.</p>
--	--

Bind Package to Different Model Library Folder

Step	Action

1	On the 'Select a Topic to Link' dialog, click on the expansion box next to the appropriate category name to display the topic folders it contains.
2	Click on the appropriate topic folder name.
3	<p>Click on the OK button.</p> <p>When you:</p> <ul style="list-style-type: none">• Create a 'Review Document', it will now be automatically stored in the selected topic folder• Select the 'Show Current Review Folder' option, the Model Library window will open with the selected folder name highlighted and expanded• Select the 'Current Reviews' option, the submenu will list the documents held in the selected folder; click on one to open it

Notes

- For a given Specification Package, you can generate as many review documents as you require
- Before you generate a Review Document from the Specification Manager, you could run the system Spell Checker over the Specification Package to remove any errors in the text

View Review Document

In the Specification Manager, you can generate a range of documents that either guide a structured review of the elements you have listed, or provide the actual material - the descriptions, features and properties of the elements - to be reviewed. These documents are, by default, stored in the 'Formal Reviews' category of the Model Library, from which point they can be accessed in a number of ways. Whichever access path you select, the document opens in the application work area and you can read the document online, edit it and/or print it.

If you want to edit or print the document, you can do so using the facilities of the common document editor, which is used in creating and editing both documents and document templates.

The Specification Manager also provides a facility for changing the default folder into which the 'Review Documents' are generated, and from which you can select the documents to open.

Access

Ribbon	To open the Library window: <ul style="list-style-type: none">• Explore > Portals > Windows > Collaborate > Team Review or• Start > Collaborate > Model Library
--------	--

Other	From the Library window: <ul style="list-style-type: none">• Formal Reviews <Package name> double-click <document name>
-------	---

Notes

- If you have changed the default folder for the Package (by binding the Package to a folder other than those in the 'Formal Reviews' category), the 'Current Reviews' and 'Show Current Review Folder' options will automatically show the new default folder and the documents it contains; if you access the Library window directly, you would need to know the name and location of the new default folder

Managing Changes

If you are responsible for a team of people who are working on the specification, you can manage their work and monitor the changes that they are making via the Specification Manager, keeping the focus on the specification work rather than having to establish the focus in each management tool separately. You use the Specification Manager to:

- Show if each element in the Package has a resource or maintenance item (the presence or absence of a column indicator on the relevant column, or in the 'All Indicators' column)
- Where the element does have a resource or maintenance column indicator, open the appropriate window by double-clicking on that icon
- Where the element does not have a column indicator, or for other monitoring tools, maintain the focus on the element for the window you open via the appropriate ribbon

Access

Ribbon	Design > Package > Specification View
--------	---------------------------------------

Management and Monitoring facilities

Facility	Description
Manage Package Baselines	<p>Press Ctrl+Alt+B or click on the 'Design > Package > Manage > Manage Baselines' ribbon option to open the 'Baselines' dialog, which you can use to capture the state of development of the Specification Package, as a Baseline. At a later point, you can compare the current state of the Package with this captured Baseline (or another one) and establish the changes that have been made since that Baseline was made.</p> <p>You can also roll back any of the changes that you do not want to keep.</p>
View Audit Trail	<p>Click on the 'Settings > Model > Auditing' ribbon option to display the Audit View and the 'Audit History' tab of the System Output window.</p> <p>You can use the Audit View initially to turn on and configure Auditing, and then to perform audit checks on changes to the elements and connectors in the Specification Package (which might include changes to objects other than those of the Specification element type). The results of the audit check are</p>

	<p>displayed both in the Audit View and in the System Output window.</p>
Resources	<p>Click on the 'Construct > Resource Management > Resources' ribbon option to display the Resource Allocation window. You can use this window to define and allocate work for the people (resources) working on the Specification Package, either at Package level or at element level (select an element on the Specification Manager before defining the work).</p> <p>You can also select the Project Tools window 'Risk', 'Effort' and 'Metrics' tabs to define other aspects of work on an element (the 'Construct > Project Management > Effort', 'Risks' and 'Metrics' ribbon options). You create and update the actual records through the '<item> Details' dialog.</p> <p>Once you have allocated a resource or defined a risk, an icon displays on the element row in the corresponding column of the Specification Manager, and in the 'All Indicators' column. You can double-click on the icon to redisplay the appropriate Project Tools window tab and review the record, and add more records</p>

	if necessary.
Maintenance	<p>Click on the 'Construct > Change Management' ribbon panel and select the appropriate option for any of these Maintenance items:</p> <ul style="list-style-type: none">• Features• Changes• Documents• Issues• Defects• Tasks <p>The corresponding tab of the Maintenance window displays, through which you can create a record to define the maintenance item for the Specification Package or a selected element within it.</p> <p>When you create one of these records, an icon displays on the element row in the 'Maintenance' and 'All Indicators' columns of the Specification Manager.</p>
Testing	<p>Click on the 'Construct > Test Management > Tests' ribbon option and select the appropriate option for any of these test types:</p> <ul style="list-style-type: none">• All

	<ul style="list-style-type: none">• Inspection• Unit• Integration• System• Acceptance• Scenario <p>The Test Cases window displays at the corresponding tab, through which you can create a record to define a Test for the Specification Package or a selected element within it (the record is actually created and edited on the '<item> Details' dialog).</p> <p>When you create one of these records, an icon displays on the element row in the 'Test' and 'All Indicators' columns of the Specification Manager. You can double-click on the icon to redisplay the Test Cases window and review the record, and to add more records if necessary.</p>
<p>View Package as Gantt or List</p>	<p>Click on the 'Design > Package > Gantt View' or 'List View' ribbon option to display the Package contents in Gantt or List format, on a separate tab. The Gantt view lists all the elements in the Package, showing their assigned resources and the</p>

progress of work on their separate tasks, both in text on the left hand side and as a graphical timeline on a calendar on the right. In List format, the elements are simply listed in a more condensed form of the Specification Manager, with no Notes text, Maintenance items or Tests. You can review the element properties or resource details by double-clicking on the item.

Notes

- If a record or entry does not display on the Specification Manager when you save the record, press F5 to refresh the display
- Package Baselines and Auditing are available in the Corporate and extended editions of Enterprise Architect
- In the Corporate and extended editions of Enterprise Architect, a User Security system can be applied that restricts or enables access to a range of operations and functions; if you cannot access a function in the Specification Manager, check with your System Administrator or Security Administrator to see if you have access permissions to work with that function

Reporting

As you develop the elements in the Specification Package, you can produce a number of documents and reports to either disseminate the information you have compiled or to extract additional information on the elements from other aspects of model development and management, that might not be immediately visible in the Specification Manager.

You can also export the data you have created to a .csv file and perhaps onwards to another tool, or import element information created outside Enterprise Architect.

Access

Ribbon	<p>Select the element in the Specification Manager, and the 'Specification - Specify > Element > Documentation' option, then the required submenu option:</p> <ul style="list-style-type: none">• Generate Documentation (DOCX/PDF/RTF)• Publish as HTML• Publish as Joomla! Article• CSV Import/Export• QA Reports and Metrics• Spell Check Current Package
--------	---

Review facilities

Facility	Description
<p>Generate documentation in report document format</p>	<p>Enterprise Architect provides a comprehensive report generation facility, through which you can create a range of reports on different aspects of your model. You can apply this facility to the elements of a Specification Package, to generate a report in any of these formats:</p> <ul style="list-style-type: none"> • DOCX • PDF • RTF <p>Select the 'Generate Documentation (DOCX/PDF/RTF)' option.</p> <p>The 'Generate Documentation' dialog displays, with the 'Element' field set to 'Selected Elements' as the target contents of the report, and the 'Template' field set to 'Specification Manager List'. The output file extension determines the output format of the document.</p>
<p>Generate documentation in web</p>	<p>As you develop the Specification Package elements you can publish them on the web, where the outline structure</p>

<p>page format (HTML)</p>	<p>closely mirrors the Package structure and makes it very simple to explore on-line. You export the Package to web pages, where the web report provides an easy to use, highly detailed, JavaScript-based structure. In addition, any hyperlinks in the elements make browsing to related information very simple.</p> <p>Select the 'Publish as HTML' option. The 'Publish as HTML' dialog displays, with the Specification Package name in the 'Package' and 'Title' fields.</p>
<p>Generate documentation as a Joomla! Article</p>	<p>An Enterprise Architect Package can be published as an Article (HTML page) in a local Joomla! installation, using the 'Publish as Joomla! Article' dialog. All child Packages of the selected Package will be automatically included for publishing.</p> <p>Select the 'Publish as Joomla! Article' option. The 'Publish as Joomla! Article' dialog displays, with the Specification Package name in the 'Package' field.</p>
<p>Generate spreadsheet file (CSV)</p>	<p>In Enterprise Architect you can import data from a spreadsheet into a Package and export element data from a Package</p>

<p>and import from a spreadsheet</p>	<p>into a .csv file.</p> <p>You can perform both of these operations within the Specification Manager, to bring in an existing set of element definitions to the Specification Package or transfer the Enterprise Architect element definitions to a different location. Select the 'CSV Import/Export' option. As part of either operation, you need to create a CSV Specification file.</p> <p>Whilst your display might be filtered to show a specific type of element, the operations work on the Package itself and incorporate all types of element within the Package.</p> <p>After you perform an import, refresh the display (press F5) to show the imported elements.</p>
<p>Generate Quality Assurance reports and Metrics</p>	<p>Enterprise Architect provides several Quality Assurance reports for checking the development and impact of development of the elements in a Package. You can access these within the Specification Manager, so that the Specification Package is automatically the target of the report.</p> <p>You can also view and adjust the metrics report should you want to monitor the</p>

	<p>impact on the project metrics of the work that the elements in the specification might entail.</p>
Spell-check the Package	<p>Before generating and/or printing any information from the Specification Manager, you could run the system Spell Checker over the Specification Package to remove any errors that might exist in the element names and text.</p> <p>Select the 'Spell Check Current Package' option to display the 'Spell Check: <Package Name>' dialog, and click on the Start button.</p>

Notes

- In the Corporate and extended editions of Enterprise Architect, a User Security system can be applied that restricts or enables access to a range of operations and functions; if you cannot access a function in the Specification Manager, check with your System Administrator or Security Administrator to see if you have access permissions to work with that function

The Data Miner

The Data Miner provides a comprehensive means of extracting data from a range of external data sources including: databases (ODBC, ADO, OLEDB, JET), text files (XML, JSON, plain text), Excel (xls, CSV), and online files or URLs.

The goal is to create a reproducible import process defined in a model format. This consists of:

- Data configuration process to hold the complex data connections and information
- Combined with the ability to run JavaScript over the data set

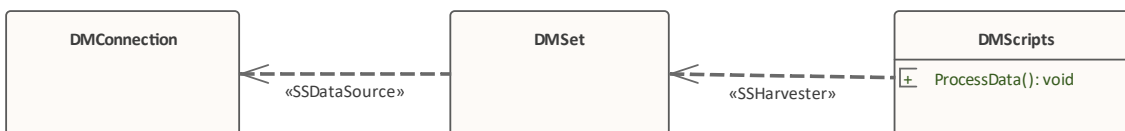

This feature is available in the Unified and Ultimate Editions of Enterprise Architect, from Release 15.0.

Access

The Perspective for the Data Miner is: Perspectives > Management > Data Miner.

The Data Miner diagram and several model patterns can be accessed through the Model Builder, while a number of model templates, model elements and connectors specific to the Data Miner facility can be accessed from the Diagram Toolbox.

Data Miner Model

The Data Miner Model allows you to define three core element types:

Element Type	Description
DMConnection	<p>A DMConnection element is used to define a connection to an external data source. Any number of DMConnections can be defined.</p>
DMSet	<p>A DMSet provides the link between the connection and the script that processes the data. It can define a query that will be applied on the connection for connection types that require it. For example, an ODBC DMConnection will require a DMSet that specifies an SQL Statement in the Query custom property, where a File DMConnection does not require the DMSet Query to be used.</p> <p>When performing data mining using SQL expressions (via ODBC or from an Enterprise Architect repository), you can visualize the retrieved data in a grid view, by right clicking on the DMSet element, and selecting 'Open Data Miner Visualizer'. This will display the returned</p>

	data in a table form.
DMScripts	A DMScript element can be used to process the raw data returned from a DMSet. It can contain one or more JavaScript scripts to process the retrieved data using the Automation Interface.

Multiple connections

A full Data Miner is defined by a DMConnection connected to a DMSet, optionally connected to a DMScripts. The mining capability can be extended in numerous ways:

- Multiple DMSet elements can query the same DMConnection
- Each DMSet can be connected to multiple DMConnection elements
- Each DMScripts can process multiple DMSet elements
- Each DMScripts element can have multiple scripts to be run on the data

Notes

- The Data Miner is available in the Unified and Ultimate Editions

Data Miner Toolbox

To create Data Miner elements and relationships on Data Miner diagrams, you can use the 'Data Miner' page of the Diagram Toolbox. The Data Miner diagram and several model patterns can be accessed through the Model Builder, while a number of model templates, model elements and connectors specific to the Data Miner facility can be accessed from the Diagram Toolbox.

Access

Use the methods outlined here for displaying the Diagram Toolbox for the Data Miner and accessing Model Builder patterns.

Perspective	Perspective > Management > Data Miner
Model Builder	<p>Set the Perspective: Perspective > Management > Data Miner</p> <p>Use the Model Builder (Ctrl+Shift+M):</p> <ul style="list-style-type: none"> • Management > Data Miner > (select pattern) or • Diagram > Type > Management > Data Miner > (select Data Miner diagram)
Ribbon	Design > Diagram > Toolbox -  to display the 'Find Toolbox Item' dialog

	and specify 'Data Miner'.
Keyboard Shortcuts	Ctrl+Shift+3 : ☰ Data Miner

Data Miner Elements

Item	Use to
DMConnecti on	Defines a connection to an external data source.
DMSet	Defines an intermediate element in the link between a DMconnection and a DMscript which is used to process the data.
DMScripts	The element type that contains JavaScript script(s) for retrieving data using the Automation Interface.

Data Miner Connectors

Item	Use to
------	--------

Data Source	Used for setting a connection from a DMSet to a DMConnection.
Data Harvester	Defines a connection from a DMScript to a DMSet.

Data Sources

A DMConnection element sets the connection to the external data source. The connection types that are supported include:

- ODBC - for connecting external databases
- EA Repository - sets a connection to an Enterprise Architect repository
- File - for file types such as CSV and XML
- External Data - access to Pro Cloud Integration
- URL - HTTP GET and POST

Setting a Data Type

To set the Data Source Type, in the Properties window, under DMConnection, select the Type from the drop-down:

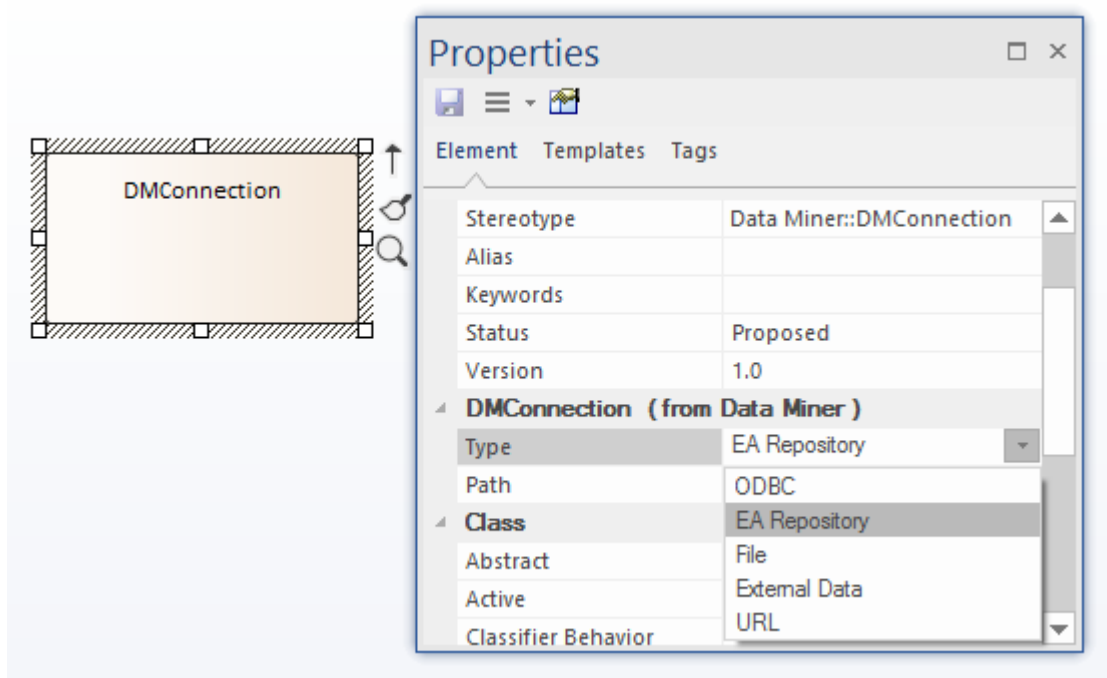

With the DMConnection Type selected, you can now enter the connection details based on the type selected.

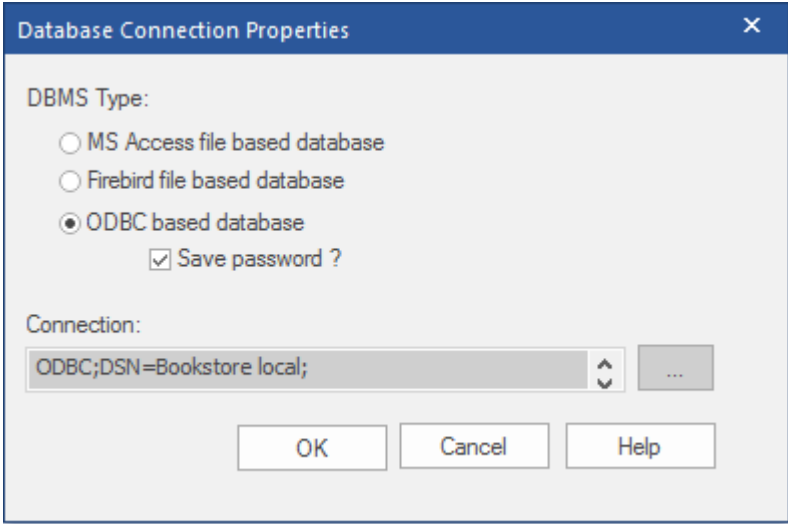
Type	Description
<p>ODBC (Open Database Connectivity)</p>	<p>An ODBC connection can be used to connect to external databases or database-like providers. Direct connections can be made to local Microsoft Access or Firebird files, or an existing ODBC connection can be used to connect to any other ODBC database provider.</p> <p>To set an ODBC connection:</p> <ul style="list-style-type: none"> • Right-click on the DMConnection element • Select 'Edit Data Miner Connection'.  <p>Select the type of database to connect to and follow the prompts to select the database.</p>

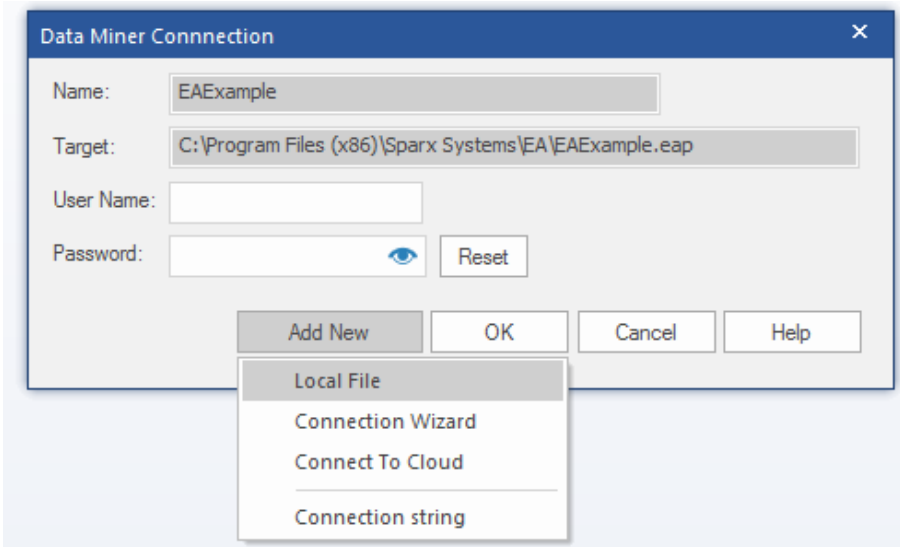
<p>Enterprise Architect Repository</p>	<p>Directly connect to another Enterprise Architect repository by selecting this type.</p> <p>To set a connection to a repository:</p> <ul style="list-style-type: none"> • Right-click the DMConnection element • Select 'Edit Data Miner Connection' • Click on the Add New button to select the connection type. 
<p>File</p>	<p>Some file types can be used in the Data Miner. In general the DMScripts processor will be given the text from the file. The Data Miner doesn't attempt to interpret the file in any way, so the script must ensure it is in the expected format.</p> <p>To set a connection to a file:</p> <ul style="list-style-type: none"> • Right-click the DMConnection element • Select 'Edit Data Miner Connection'

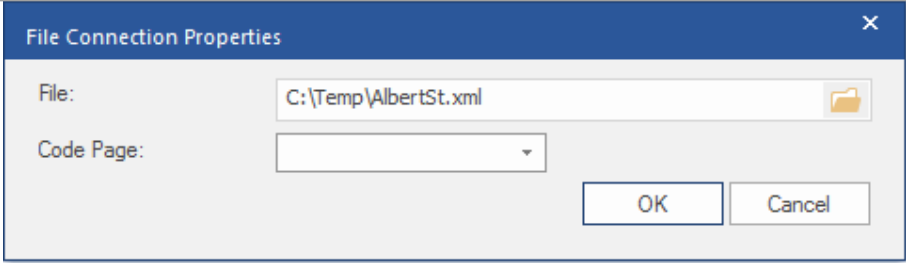
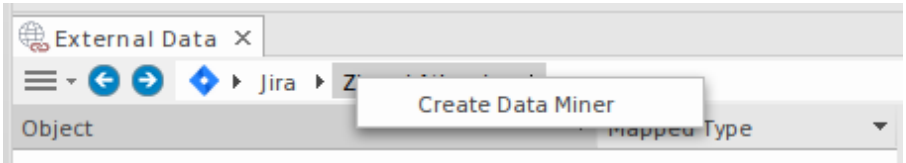
	 <p>The screenshot shows a dialog box titled "File Connection Properties". It has a "File:" field containing "C:\Temp\AlbertSt.xml" and a "Code Page:" dropdown menu. There are "OK" and "Cancel" buttons at the bottom right.</p>
<p>External Data</p>	<p>The Data Miner External Data connection is for linking to an existing Enterprise Architect Integration external source. This requires that the Pro Cloud Integration feature has been configured to access an external source.</p> <p>To configure an External Data connection:</p> <ul style="list-style-type: none"> • Select from the Ribbon : Specialize > Tools > System Integration > Open External Data • Browse to the list of items to be retrieved • right-click on the Integrations menu item and select 'Create Data Miner'.  <p>The screenshot shows a context menu with the option "Create Data Miner" highlighted. The background shows a ribbon with "Jira" selected.</p> <p>This will create a DMConnection element with all the required connection settings to retrieve the external data.</p>
<p>URL</p>	<p>Text can be retrieved from online by specifying a URL. It's possible to add</p>

simple authentication and extra headers to the request and to send as a HTTP 'GET' or 'POST' request.

- Right-click the DMConnection element
- Select 'Edit Data Miner Connection'

URL Connection Properties

URL:

Method:

Username:

Password:

Ignore SSL errors

Data to POST:

```
{
  "jql": "project = GCS AND issuetype in (Bug, Epic, Story) AND status in (In Progress, To Do) ORDER BY Rank ASC",
  "startAt": 0,
  "maxResults": 100
}
```

Name	Value
Content-Type	application/json

OK Cancel

The Data Miner will not attempt to interpret the data. It will pass it to the DMScripts as simple text.

Properties:

URL - Set the URL to access the data.

Method - Options:

- GET
- POST
- PUT

User - Sets the User Name for authorized access.

Password - Sets the user access password.

Ignore SSL Errors - Set this to ignore

returned SSL errors.

Data to POST - Send additional data along with the request when the server requires it. Setting this is usually only required when a 'method' is 'POST' or 'PUT'.

Additional Headers - Set any additional headers required in the URL. Standard headers will be included automatically.

Note: Check the API documentation of the server for any required headers.

Notes

- The settings are stored in the Data Miner section in the element Properties, in the 'Path' field; while this memo field can be edited directly, we recommended that you avoid doing so
- Each DMConnection can be harvested by multiple DMSet elements
- Multiple DMConnection elements can be harvested by a single DMConnection

Data Miner Set

A Data Miner Set element (DMSet) can be used to return a set of data from a DMConnection element. It will retrieve data from all DMConnection elements that it is connected to, and optionally run a query on connections that support or require it.

Data Miner Set - Type

The Data Miner has two options for the Type:

- SQL
- None

The SQL Type setting can be used with Data Sources that are set to the Type - 'ODBC' or 'EA Repository'. For the other Data Source types, set this option to None. The DMSet Type is set in the Properties window (Ctrl+2) > DMSet > Type.

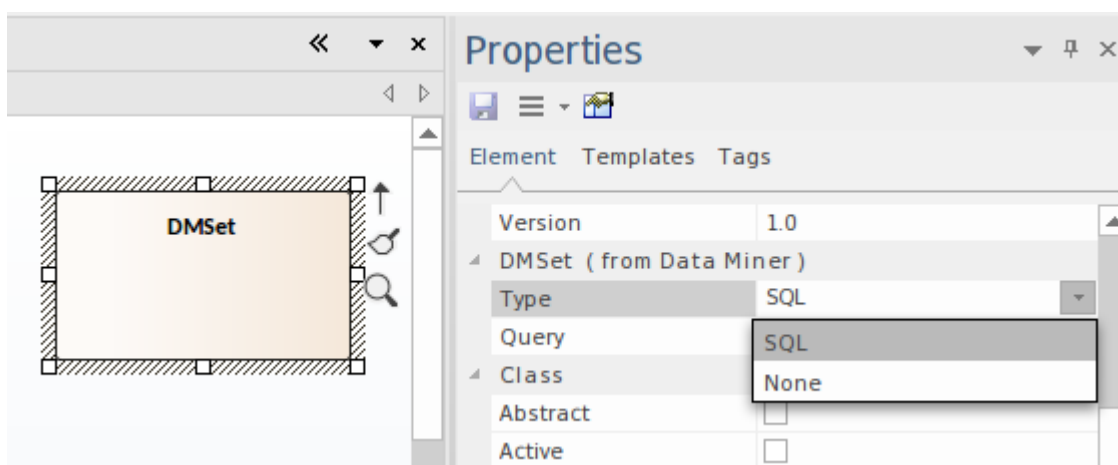

Data Miner Visualizer

For a Data Miner Set that is typed as SQL, you can access the Data Miner Visualizer. This is used for setting a SQL query to be run, that returns the set of data to be processed in the Data Miner Script. The Visualizer also shows the results of the SQL query.

To access this:

- Right-click on a DMSet element
- From the context menu, select Open Data Miner Visualizer

For more details see the *Data Miner Visualizer* Help topic.

Notes

- Each DMSet can harvest data from multiple DMConnection elements
- Multiple DMSet elements can harvest data from a single DMConnection

Data Miner Visualizer

If you are using an SQL query, the Data Miner Visualizer is a handy way to see the data that will be retrieved by the Data Miner. It provides a quick and easy means to modify the SQL query and check the returned data.

To create a query:

- Right click the DMSet element
- Select 'Open Data Miner Visualizer'.
- Type in the query to be run
- Click the play button.

For a correct SQL statement this will return a set of rows containing the retrieved data.

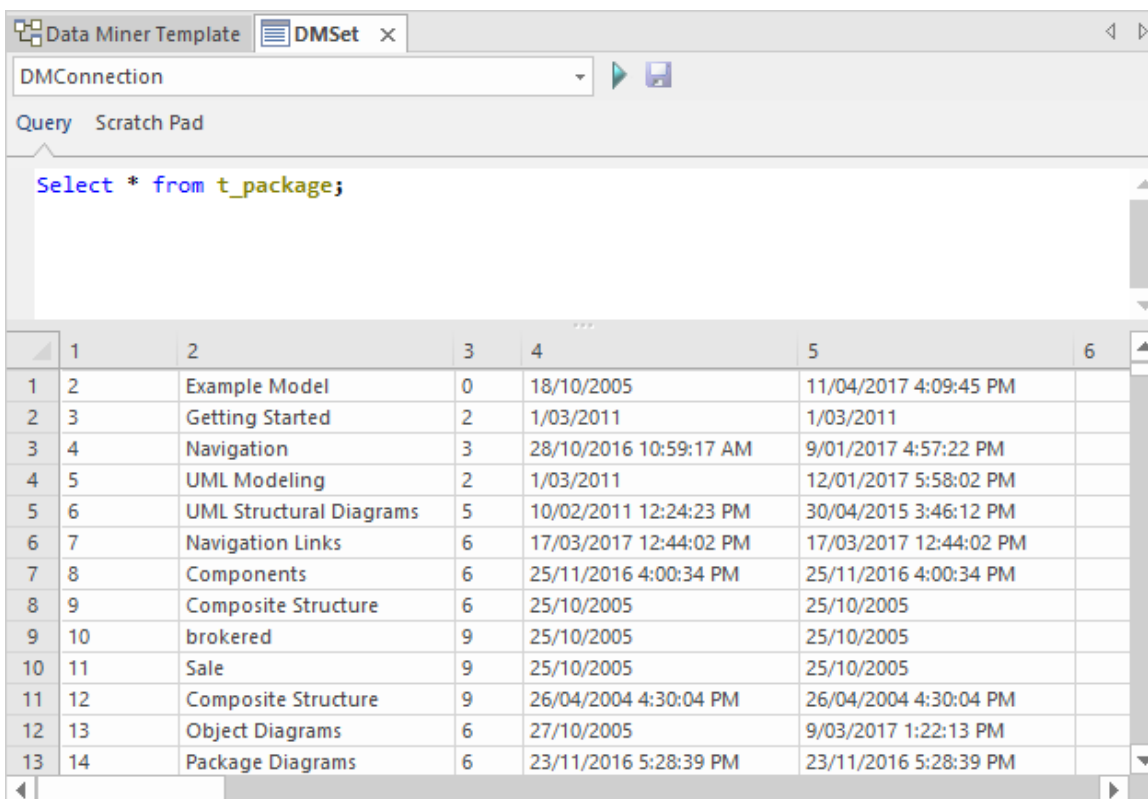

The screenshot shows the Data Miner Visualizer interface. At the top, there is a tab labeled 'Data Miner Template' and a sub-tab 'DMSet'. Below this, a dropdown menu shows 'DMConnection'. A 'Query' tab is active, displaying a 'Scratch Pad' with the SQL query: `Select * from t_package;`. Below the query editor is a table with 6 columns and 13 rows of data. The columns are numbered 1 through 6. The rows contain data for various package elements, including their IDs, names, counts, dates, and times.

	1	2	3	4	5	6
1	2	Example Model	0	18/10/2005	11/04/2017 4:09:45 PM	
2	3	Getting Started	2	1/03/2011	1/03/2011	
3	4	Navigation	3	28/10/2016 10:59:17 AM	9/01/2017 4:57:22 PM	
4	5	UML Modeling	2	1/03/2011	12/01/2017 5:58:02 PM	
5	6	UML Structural Diagrams	5	10/02/2011 12:24:23 PM	30/04/2015 3:46:12 PM	
6	7	Navigation Links	6	17/03/2017 12:44:02 PM	17/03/2017 12:44:02 PM	
7	8	Components	6	25/11/2016 4:00:34 PM	25/11/2016 4:00:34 PM	
8	9	Composite Structure	6	25/10/2005	25/10/2005	
9	10	brokered	9	25/10/2005	25/10/2005	
10	11	Sale	9	25/10/2005	25/10/2005	
11	12	Composite Structure	9	26/04/2004 4:30:04 PM	26/04/2004 4:30:04 PM	
12	13	Object Diagrams	6	27/10/2005	9/03/2017 1:22:13 PM	
13	14	Package Diagrams	6	23/11/2016 5:28:39 PM	23/11/2016 5:28:39 PM	

Where there are connections to multiple DMConnection elements, use the drop-down to select another

DMConnection.

The Data Miner Visualizer has two tabs:

- **Query**

This is where the SQL query is defined.

Click on  button to test the query.

Click on the  button to save the query to the DMSet - Query.

- **Scratch Pad**

The Scratch Pad can be used to test out new queries without having them saved to the DMSet element.

Click on  button to test the query.

Data Miner Scripts

A Data Miner Scripts element (DMScripts) can be used to process the raw data returned from a DMSet. The script is written in JavaScript and will receive the data in a number of different formats, depending on the source.

Add a new script

The scripts to be run are defined as 'Operations' on the DMScripts element. Add one or more operations and define the JavaScript code to be run on the Data Miner data.

For access to starter scripts you can use a Pattern or use the Model Builder to create a new Data Miner model:

- Select a Package in the Browser window
- Set the Perspective to: Perspective > Management > Data Miner.

Then either:

- Create a new Data Miner diagram
- Drag a Pattern from the Toolbox

Or:

- Open the Model Builder
- Locate the Data Miner pattern you want to use
- Click on the Create Model button to create one of the Data Miner models in your Package

The DMScript element will contain sample JavaScript code to use as a starter for creating your own Data Miner.

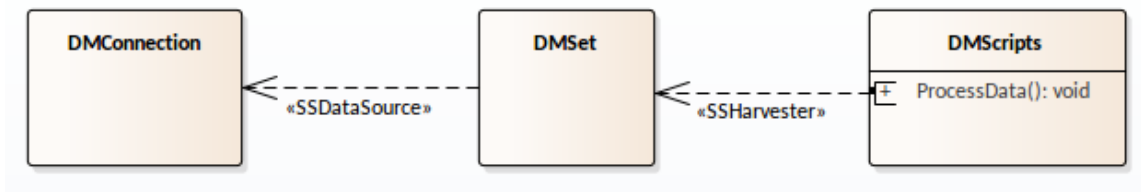

Connecting a script operation to a DMSet

The connection between a DMScript and a DMSet must be a connection to a specific operation in the DM Script element, not just to the DM Script element itself. The connector type is 'Harvester'.

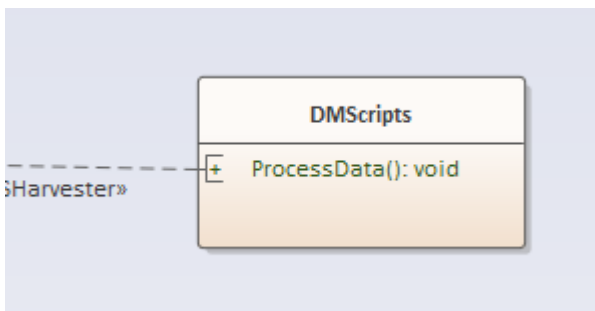

To set this connection:

- Select the **DMScripts** element
- Click on the operation in the element
This will show the **Feature Linker** on the side of the element:

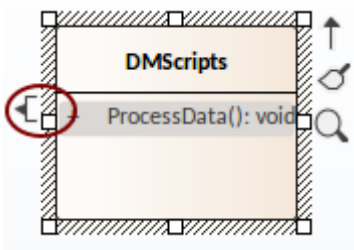

- Drag the **Feature Linker** to the **DM Set** element
- Select **Harvester** in the context menu.

Each script operation can be connected to multiple DMSet

elements and, when run, will receive each data set in turn.

Script

The script is written in JavaScript and uses the Data Miner Package automation classes. To access the Script for editing:

- Select the DMScripts element
- Right-click on the element
- Select **Edit Data Miner Processor**.

For more details on using the Data Miner automation, see the *Data Miner Package* Help topics. For more details on using the automation to create elements and connectors in the model see the *Element Package* and *Connector Package* under the automation *Reference* Help topic.

Run the Data Miner

Run all scripts:

- Right click on the DMScripts element
- Select **Run Data Miner Processor**.

Run a specific script:

- Select the script operation in the DMScripts element
- Right click the script operation and select **Run**.

Model Validation



You use Model Validation to check UML models against known UML rules. The set of rules to validate against can be customized by enabling and disabling certain rules and rule categories. You can run Model Validation against a single UML element, a diagram or an entire Package. You can add to the system-provided validation rules by using an Add-In or an MDG Technology (such as BPMN) that contains its own rules. Model based add-ins are an effective tool for creating new and specific rules sets that implement custom rules specifically related to a single project, client or domain.

Access

Ribbon	Design > Package > Manage > Validate > Validate Current Package
--------	---

Validation Concepts

Concept	Detail
---------	--------

Validating Objects	Validating a UML: <ul style="list-style-type: none">• Element validates the element and its children, its features (attributes and operations) and its relationships (connectors)• Diagram validates the diagram itself (for correctness) as well as any elements and connectors within the diagram• Package validates the Package and all sub-Packages, elements, connectors and diagrams within it
Example - Model Violation	This UML diagram contains several basic violations of the UML rules:

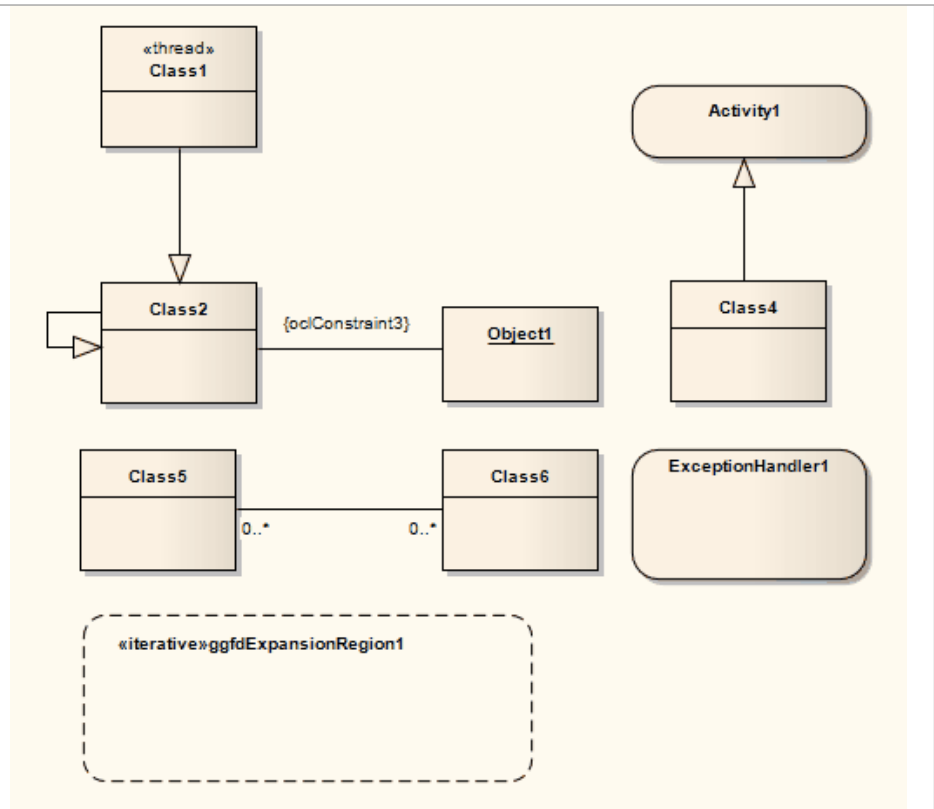

If you run Model Validation on this diagram, these violations are identified in the System Output window:

- A UML ExpansionRegion (ExpansionRegion1) is missing its child input ExpansionNode
- An invalid self-generalization exists on Class2 (UML elements cannot be self-generalized)
- An OCL violation exists for the anonymous Association (between Class2 and Object1)
- A UML ExceptionHandler (ExceptionHandler1) is missing its

	child input ObjectNode
--	------------------------

Configure Model Validation

Before you perform a model validation, you enable or disable the rules that are applied by the model validator. You can define additional rules from any additional Add-Ins that might be installed besides Enterprise Architect.

Access

Ribbon	Design > Package > Manage > Tools > Validate > Configure Validation Rules
--------	---

Configure Validation

On the 'Model Validation Configuration' dialog, click on the checkbox against each Validation Rule to apply in performing a model validation. Click on the OK button to set the validation rules selected.

Run Validation

After you have configured the validation you want to perform and set the validation rules to be applied, you can execute the validation on objects you have selected from either the Browser window or a diagram. If you do not want to continue a validation you have started, you can cancel it.

Access

Ribbon	Design > Package > Manage > Validate > Validate Current Package
Keyboard Shortcuts	Ctrl+Alt+V

Validation

While the validation executes it displays a progress window. When validation is complete, the results are displayed in the System Output window. You can highlight and select on a diagram the element that an error message refers to, by double-clicking on the error line in the System Output window.

Cancel Validation

At any time during a validation, either:

- Click on the Cancel Validation button on the validation progress window, or
- Select 'Design > Package > Manage > Validate > Cancel Current Validation'

Notes

- If the System Output window does not automatically display, select 'Start > All Windows > Design > Explore > System'.

Rules Reference

Model Validation works by applying a set of validation rules to the selected object. These rules are arranged in groups.

Rule Groups

Group	Description
Well-Formedness	<p>The validator applies these rules to check whether or not an element, relationship, feature or diagram is well-formed; for example, whether the object is a valid UML item or whether a diagram contains valid elements within it.</p> <p>As explained in <i>Error Message Format</i>, these rules generate messages with the codes:</p> <ul style="list-style-type: none">• MVR01... (Element: Well Formedness checkbox selected)• MVR05... (Relationship: Well Formedness checkbox selected)• MVR08... (Feature: Well Formedness checkbox selected)• MVR0B... (Diagram: Well Formedness checkbox selected)

<p>Element Composition</p>	<p>The validator applies these rules to check whether or not a UML element contains valid children, whether it contains the right number of valid children, and whether or not the element is missing any required children.</p> <p>These rules generate messages with the code:</p> <ul style="list-style-type: none"> • MVR02... (Element: Composition checkbox selected)
<p>Property Validity</p>	<p>The validator applies these rules to check whether or not the element, relationship or feature has the correct UML properties defined, and whether the properties contain incorrect or conflicting values.</p> <p>These rules generate messages with the codes:</p> <ul style="list-style-type: none"> • MVR03... (Element: Property Validity checkbox selected) • MVR06... (Relationship: Property Validity checkbox selected) • MVR09... (Feature: Property Validity checkbox selected)
<p>Custom Properties</p>	<p>The validator applies these rules to check an element, relationship or feature against any defined constraints in OCL.</p>

These rules generate messages with the codes:

- MVR04... (Element: OCL Conformance checkbox selected)
- MVR07... (Relationship: OCL Conformance checkbox selected)
- MVR0A... (Feature: OCL Conformance checkbox selected)

Error Message Format

When you perform a validation, any violations of the rules are listed on the System Output window. Each violation has a violation ID of the format:

MVRxxnnnn

- MVR stands for Model Validation Rule
- xx is a hexadecimal number corresponding to the position of the validation rule in the 'Model Validation Configuration' dialog, thus indicating which rule is applied and violated
- nnnn is the number of the violation message

For example:

- Messages with the ID MVR01nnnn indicate that the 'Element: Well-Formedness' checkbox is selected and a violation of that rule has been detected
- Messages with the ID MVR0Annnn indicate that the

'Feature: OCL Conformance' checkbox (10th in order on the dialog, or Ath in hexadecimal) is selected and a violation of that rule has been detected

Well-Formedness

Well-formedness rules are applied to check whether or not an element, relationship, feature or diagram is well-formed. For example, whether the target item is a valid UML item, or whether a diagram contains valid elements within it.

Reported violations

Violation ID	Description
MVR010001	«Element» is not a valid UML Element Error: The element is not a recognized UML 2.5 element.
MVR050001	«Relationship» is not a valid UML Relationship Error: The relationship is not a recognized UML 2.5 relationship.
MVR050002	«Relationship» is not legal for «Start Element» --> «End Element» Error: The relationship between the given start and end elements is not valid for those elements.
MVR050003	«Parent Element»:isLeaf=true and cannot be generalized by «Child Element»

	Error: The Generalization relationship cannot exist between parent and child elements because the parent element is defined as a leaf element.
MVR050004	<p>«Child Element»:isRoot=true and cannot generalize «Parent Element»</p> <p>Error: The Generalization relationship cannot exist between parent and child elements because the child element is defined as a root element.</p>
MVR050005	<p>«Element» cannot generalize self</p> <p>Error: The element cannot be self-generalized.</p>
MVR0B0001	<p>Statechart violation: «extended information»</p> <p>Error: The State diagram contains a UML violation; «extended information» provides more details on the specific violation.</p>
MVR0C0001	<p>Sequence Violation: «extended information»</p> <p>Error: The Sequence diagram contains a violation, «extended information» provides more details about the specific</p>

	<p>violation.</p> <p>(This rule validates operations being called by Messages - as selected from the drop down combo box of the 'Messages Properties' dialog - and will report a violation if the operation does not belong to the Lifeline.)</p>
MVR7F0001	<p>«Requirement» Not realized</p> <p>Error: A Requirement element must be at the target end of a Realization, Association (including Aggregation and Composition) or Generalization connector.</p>

Element Composition

Element Composition rules are applied to check whether or not a UML element contains valid children, whether it contains the right number of valid children, and whether or not the element is missing any required children.

Reported violations

Error ID	Description
MVR020001	<p>«Element» is missing required child element «Child Element»</p> <p>Information: The element is missing a child element of type Child Element.</p>
MVR020002	<p>Invalid UML Package child</p> <p>Information: The element cannot be a direct child of the Package and must be a child of another element (for example, Ports must be children of other elements, and not direct UML Package members).</p>
MVR020003	<p>Invalid child «Child Element name» («Child Element Type»)</p> <p>Information: The child element is invalid on the tested parent element.</p>

Property Validity

Property Validity rules are applied to check whether or not an element, relationship or feature has the correct UML properties defined for it and whether they contain incorrect or conflicting values.

Reported violations

Error ID	Description
MVR030001	<p>«Element»:«Property» property is undefined</p> <p>Information: The element property contains no value.</p>
MVR030002	<p>«Element»:«Property» property has invalid value: "«Value»"</p> <p>Information: The element property contains an invalid value.</p>
MVR030003	<p>«Element»:isLeaf=true and cannot be abstract</p> <p>Information: The element's isLeaf and isAbstract properties are both set to True, which is invalid.</p>
MVR060001	<p>«Relationship»:«Property» property is</p>

	<p>undefined</p> <p>Information: The relationship property contains no value.</p>
MVR060002	<p>«Relationship»:«Property» property has invalid value: "«Value»"</p> <p>Information: The relationship property contains an invalid value.</p>
MVR090001	<p>Attribute/AssociationEnd mismatch, «Attribute»: «Mismatch description», ...</p> <p>Information: The given attribute has an associationEnd of the same name but they differ in the listed details.</p>

OCL Conformance

OCL Conformance rules are applied to validate an element, relationship or attribute against any defined constraints in the Object Constraint Language (OCL). OCL is used to describe expressions on UML models, and to express constraints free of side-effects. You can add OCL constraints to any element, relationship or attribute in Enterprise Architect.

Define OCL Constraints

You can add an OCL constraint to a model object by setting OCL as the Constraint type in the object 'Properties' dialog.

For	Detail
An Element	<p>Right-click on the element and select 'Properties Properties Dialog'. Click on the 'Constraints' page; in the 'Type' field click on the drop-down arrow and select OCL.</p> <p>To perform an OCL Validation:</p> <ol style="list-style-type: none">1. Select 'Design > Package > Manage > Tools > Validate > Configure Validation Rules' and select the 'Element: (OCL) Conformance' checkbox.2. Click on the element and select 'Design > Package > Manage > Tools >

	<p>Validate > Validate Current Package'. Any OCL syntax violations are recorded in the 'Model Validation' tab of the System Output window.</p>
<p>A Relationship</p>	<p>On a diagram, right-click on the connector and select the 'Properties' option; select the 'Constraints' page, and in the 'Type' field click on the drop-down arrow and select 'OCL'.</p> <p>To perform an OCL Validation:</p> <ol style="list-style-type: none"> 1. Select 'Design > Package > Manage > Tools > Validate > Configure Validation Rules' and select the 'Relationship: (OCL) Conformance' checkbox 2. Click on the connector and select 'Design > Package > Manage > Tools > Validate > Validate Current Package' <p>Any OCL syntax violations are recorded in the 'Model Validation' tab of the System Output window.</p>
<p>An Attribute</p>	<p>Right-click on the element and select 'Attributes Constraints'; in the 'Type' field, click on the drop-down arrow and select 'OCL'.</p> <p>To perform an OCL Validation:</p>

	<ol style="list-style-type: none"> 1. Select 'Design > Package > Manage > Validate > Configure Validation Rules' and select the 'Feature: (OCL) Conformance' checkbox. 2. Click on the element and select 'Design > Package > Manage > Validate > Validate Current Package'. <p>Any OCL syntax violations are recorded in the 'Model Validation' tab of the System Output window.</p>
--	---

Reported violations

Error ID	Description
MVR040001	OCL violation: «violated OCL» Information: The element's OCL constraint uses incorrect syntax.
MVR070001	OCL violation: «violated OCL» Information: The relationship's OCL constraint uses incorrect syntax.
MVR0A0001	OCL violation: «violated OCL» Information: The attribute's OCL constraint uses incorrect syntax.

Notes

- To have a valid OCL constraint, the syntax must be correctly formed; if the expression is not correct, a message displays stating that the OCL constraint is not valid

Model Options

The 'Manage Model Options' dialog provides facilities for configuring various actions of Enterprise Architect for the current model or project, affecting all users of that model. When you open the dialog it defaults to the 'General' page, which helps you to set the system behavior options such as the required release of Enterprise Architect, diagram text appearance, Sequence message spacing and SysML Control Flows format.

The dialog also has pages for identifying MDG Technologies; the Cloud configuration; Reusable Asset Service Registry configuration for Baselines; the central connection for managing Collaboration text such as Model Diary entries, Model Mail and Chats; the element status that locks elements against review comments, and Code Engineering options and code language options that are specific to the model.

Access

Ribbon	Settings > Model > Options
--------	----------------------------

Control System Behavior

Field/Button	Action
File Directory	Type in the default directory name for the shared files you define on the 'Files' tab of an element's 'Properties' dialog (maximum 50 characters).
Minimum Version	Click on the drop-down arrow and select the minimum release of Enterprise Architect required to open this model.
Minimum Build	Type in the number of the earliest build required to open this model. Alternatively, click on the Select Current button to select the build of the system that the model is currently open in.
Font Face	Click on the drop-down arrow and select the font in which to display all element text in diagram renditions of elements.
Font Size	Click on the drop-down arrow and select the font size in which to display all element text in diagram renditions of elements.
Clear	Click on this button to clear the 'Font Face' and 'Font Size' fields.

Notes Font	Click on the drop-down arrow and select the default font of all text displayed in Notes elements and fields on diagrams.
Clear	Click on this button to clear the 'Notes Font' field.
Ignore image transparency	<p>Select this checkbox to ignore transparency for all images in the model, effectively rendering them as 24 bit images.</p> <p>Deselect the checkbox to show the transparency for all (32 bit) images on which it has been used.</p> <p>If you change the selection, you must restart Enterprise Architect to bring that change into effect.</p>
Message Spacing	<p>Type in the vertical gap (in points, between 15 and 45) to maintain between Sequence Messages on a Sequence diagram.</p> <p>This spacing can be overridden manually by dragging a Message up or down.</p>
Enable Structure Compartments	Defaults to selected to automatically display Structure compartments on elements in rectangular notation on diagrams across the model. Clear the

	checkbox if you do not want to display Structure compartments on elements.
<p>XMI/VC Import Policy for Discussions</p>	<p>Click on the drop-down arrow and select an option that determines how to import Discussions from XMI:</p> <ul style="list-style-type: none"> • Always Merge - select this option to retain the existing Discussions in the model and merge those in XMI • Always Restore - select this option to delete the existing Discussions in the model and import those in XMI <p>Notes :</p> <ul style="list-style-type: none"> • The selected option determines how Discussions are imported during these imports: XMI 1.1, XMI 2.1, Native XML, Package Control, Version Control and Baselines • The selected option can be overridden in the 'Import Package from Native/XMI File' dialog if the checkbox 'Allow user to override if prompted' is selected • In Corporate, Unified and Ultimate Editions of Enterprise Architect, if security is enabled then only the Admin administrator or a user in the

	Administrators group can select these options
Allow user to override if prompted	Select the checkbox to override the option selected for 'XMI/VC Import Policy for Discussions' in the 'Import Package from Native/XMI File' dialog.

SysML Options

Field/Button	Action
Dashed Line for Control Flow	<p>Select this option to draw all control flows on SysML diagrams as dashed lines. Deselect this option to draw all control flows on SysML diagrams as solid lines.</p> <p>This option does not affect control flows on non-SysML diagrams, which will always be drawn as solid lines.</p>

Notes

- In the Corporate, Unified and Ultimate Editions of Enterprise Architect, if security is enabled you must have

'Manage Project Settings' permission to set, change or clear the 'Font Face' and 'Font Size' fields, and to enable/disable diagram image-maps

- Similarly, if security is enabled you must have 'Configure Project Prerequisites' permission to update the 'Minimum Version' and 'Minimum Build' settings
- You can also define User fonts on the 'Preferences' dialog that apply to any diagram you display in any model; the User font is overridden by the Model font, to ensure that all members of the project team have a consistent and coherent view of the model
- Model fonts are themselves overridden by specifically-defined element fonts, so that the element is viewed as designed regardless of the model defaults; to define the font for a specific element, right-click on the element in a diagram and select the 'Appearance | Set Font' option
- It is recommended that a project authority sets the Model font, and all project members abide by it and do not change it without project approval; in editions where security is enabled, changes can be restricted by allocating permission only to the project authority

Baseline Page

Package Baselines in Enterprise Architect can be stored either within the model or in a Reusable Asset Service (RAS) Registry. The 'Baseline' page of the 'Manage Model Options' dialog provides the option to specify which storage method to use.

If a Project or Model Administrator decides to store Package Baselines in a Registry, the 'Baseline' page also provides options to:

- Configure the Cloud Connection to the Registry
- Select an existing Storage or create a new Storage in the Registry in which to store the Baselines
- Configure Registry-specific Baseline options

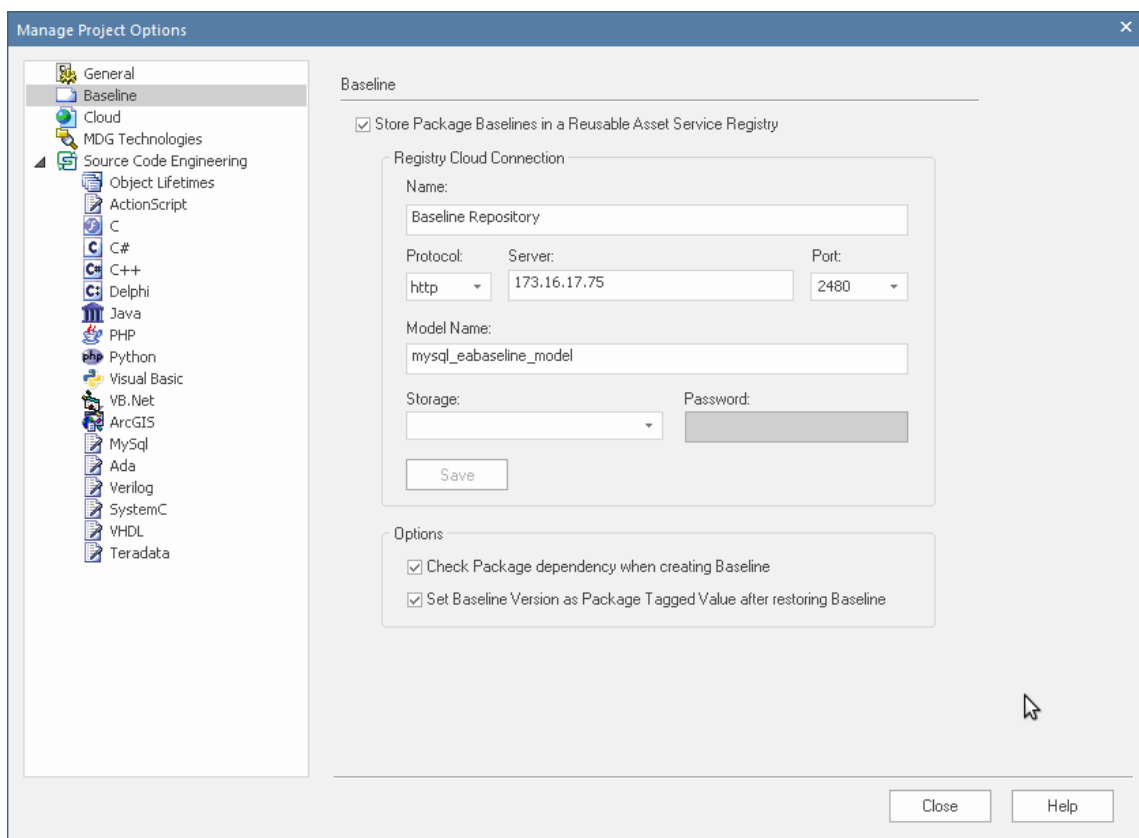

The information to define the repository and model will be provided by the Project Administrator for the user to enter. Depending on the access granted to the user, the administrator might identify the Storage and Password to use, or the user might define their own Storage.

Access

Ribbon	Settings > Model > Options > Baseline
--------	---------------------------------------

Configuration Options

Option	Description
Store Package Baselines in a Reusable Asset Service Registry	<p>By default, Package Baselines are stored within the model. If you leave this checkbox empty and ignore the remaining fields on this page, when a user in the model selects to create or review a Baseline the 'Baseline' dialog displays. See the <i>Manage Baselines in Model</i> Help topic.</p> <p>To store Package Baselines in a Registry, click on and enable this checkbox. Once the checkbox is enabled you can configure the Registry Cloud Connection</p>

	<p>and Registry-specific Baseline options on the rest of the page.</p> <p>When the connection has been established and when a user selects to create or review a Baseline the 'Reusable Asset Service - Baseline' view displays. See the <i>Manage Baselines in Reusable Asset Service Registry</i> Help topic.</p>
Name	<p>Type the name by which to refer to the Reusable Asset Service (RAS) Registry. The name does not have to match any values on the server; it will appear in the 'Registry' field in the 'Reusable Asset Service - Baseline' view.</p>
Protocol	<p>Click on the drop-down arrow and select a secure (https) or insecure (http) connection, as supported by the server you are connecting to. When you select the protocol, the Port will automatically be set to match the default for that protocol.</p>
Server	<p>Type in the machine name (for example, 'sparxcloud.com') or IP address (for example, '192.168.0.20') of your server.</p>
Port	<p>If necessary, click on the drop-down</p>

	<p>arrow and select the Port number the service is listening on. This should match the settings in the configuration file on the server.</p> <p>Note: For a server, the default settings will use Port 80 for http and Port 443 for https.</p>
Model Name	Type in the name of the model available on the server.
Storage	<p>Once the 'Name', 'Protocol', 'Server', 'Port' and 'Model Name' fields have been completed, click on the 'Storage' field to select the Storage in which to store the Package Baselines.</p> <p>If Enterprise Architect is unable to connect to the Reusable Asset Service (RAS) Registry using the provided connection details, an 'Unable to connect to the specified Registry' message will be displayed.</p> <p>If connection is successful, then the 'Storage' field drop-down list will display all available Storages in the Registry that can store Package Baselines. You can select one of these existing Storages to store the Baselines for this Model.</p> <p>Alternatively, you can create a new</p>

	<p>Storage by selecting the 'Create New Storage' option in the list. This displays the 'New Storage' dialog; use this dialog to create a new Storage in the Registry. Once saved, the newly-created Storage will be selected in this field.</p> <p>Note : The connected Reusable Asset Service (RAS) Registry could be password-protected to prevent users from modifying the Registry. In such a scenario will be prompted to enter a valid Administrator password before you can create a new Storage using the 'New Storage' dialog.</p>
<p>Password</p>	<p>If the selected Storage is password-protected against user changes, the 'Password' field will become enabled. Enter a valid password to store Package Baselines from the selected Storage.</p> <p>Notes:</p> <p>Storages can be protected by a 'Complete Access' and/or 'Read-Only Access' password. Depending on the type of password entered, Enterprise Architect will allow these operations on a Storage:</p> <ul style="list-style-type: none"> • 'Complete Access' password - allows the user to create and retrieve Package Baselines from the Storage

	<ul style="list-style-type: none"> • 'Read-Only Access' password - allows the user to retrieve Package Baselines but not create new ones in the Storage
Save	Click on this button to save the Registry Cloud Connection details.
Modify	Once the Registry Cloud Connection details have been successfully saved, the Save button will become a Modify button. Click on this button to modify or update the saved Registry Cloud Connection details.
Check Package dependency when creating Baseline	<p>Select this option to check whether the Package being baselined is dependent on any external content; that is, whether it links to any modeling component (such as an element or diagram) held in another Package in the model.</p> <p>If the Package is dependent on external modeling components, the name and Global Unique Identifier (GUID) of each Package holding those modeling components will be recorded along with the Baseline. This information will be displayed in the 'Dependency' tab of the 'Reusable Asset Service - Baseline' view.</p> <p>Note : Enterprise Architect will perform a</p>

	'Complete' type of dependency check when creating a baseline of a Package.
Set Baseline Version as Package Tagged Value after restoring Baseline	Select this option to set the Baseline Version as a Tagged Value on the Package after completely restoring the Package from a Baseline.

Notes

- The Baseline facility is available in the Corporate, Unified and Ultimate Editions of Enterprise Architect
- If security is enabled, you must have 'Baselines - Manage' permission to store Package Baselines in a Reusable Asset Service Registry

Cloud Page

The 'Cloud' page is generally maintained by a model or project administrator, with 'Administration' permissions. It provides options to:

- Configure the Properties window for each element and diagram to provide a WebEA URL that can be copied and sent to a user (by, for example, email) so that they can directly link to that object in WebEA
- Enable HTML pages for Linked Documents, and Diagram Images and Image Maps for all Enterprise Architect diagrams, to be generated and updated in cache for access from WebEA

Configuration Options

Option	Description
Maximum Query Time	You use this option to set the length of time that the Enterprise Architect client will wait for a response from the Pro Cloud Server. For example, if a user is running a custom search or other data request and Enterprise Architect times out before the PCS response arrives, you can extend the time the Enterprise Architect client will wait for the response.

	<p>Click on the drop-down arrow and select from the time options - 60, 120, 180 or 300 seconds.</p> <p>Note that for this option to work you must be using PCS 4.2.65 or later and be a member of the Administrators User Group.</p>
<p>Disable XMI Import over a Cloud Connection for this Model</p>	<p>You select this option to prevent users from being able to import XMI files into the model through a Cloud connection. This avoids the potential of large import transactions being affected by connection problems. When this option is set, users can still perform XMI imports using a direct connection.</p> <p>Note that this option disables not only XMI Import (XMI 1.1/2.1) but also any Native file (Native XEA/XML) import, effectively also disabling:</p> <ul style="list-style-type: none">• Restoring baselines that are stored in the model• Restoring baselines that are stored in RAS (see the <i>Manage Baselines</i> Help topic)• Importing Packages from RAS• Loading and batch-importing controlled Packages (see the <i>Using</i>

	<p><i>Controlled Packages</i> Help topic)</p> <ul style="list-style-type: none"> • importing Version Controlled Packages
URL	<p>Type the fully qualified URL (including protocol, server name or IP and port) of the site hosting this model in WebEA. For example: <code>https://localhost:1443</code></p>
Model Number	<p>Type the position number of this model in the list of models presented in the WebEA 'Login' page. (As in the [model_list] section of the WebEA config file.)</p>
Use this Theme on Images	<p>Click on the drop-down arrow and select the diagram theme to apply to diagram images in WebEA.</p>
Use this Scale on Images	<p>Overtyping the field with a value between 100 and 200 to define the scale of the WebEA images.</p>
Auto create Diagram Image and Image Map (each time a Diagram is	<p>(In the Corporate, Unified and Ultimate Editions) Select this checkbox to create Diagram Images and image-maps for all diagrams. These images and image-maps will be automatically updated whenever the diagram content changes.</p>

<p>saved)</p>	<p>This option is necessary for publishing the model via the Pro Cloud in WebEA. Deselect the checkbox to stop creating images and image-maps for diagrams. A prompt displays through which you specify whether to retain or delete the existing images and image-maps in the model.</p>
<p>Auto create HTML Page (each time a Linked Document is saved)</p>	<p>(In the Corporate, Unified and Ultimate Editions) Select this checkbox to create HTML pages for all Linked Documents in the model. These HTML pages will be automatically updated whenever the Linked Document content changes. This option is necessary for publishing the model via the Pro Cloud in WebEA. Deselect the checkbox to stop creating HTML pages for Linked Documents. A prompt displays through which you specify whether to retain or delete the existing HTML pages in the model.</p>
<p>Batch create Diagrams and/or Linked Documents cache</p>	<p>(Only if you have selected the 'Auto create Diagram Image and Image Map' and/or 'Auto create HTML Page' options.) Click on the 'Create' button to page through the diagrams and Linked Documents of the model, creating an</p>

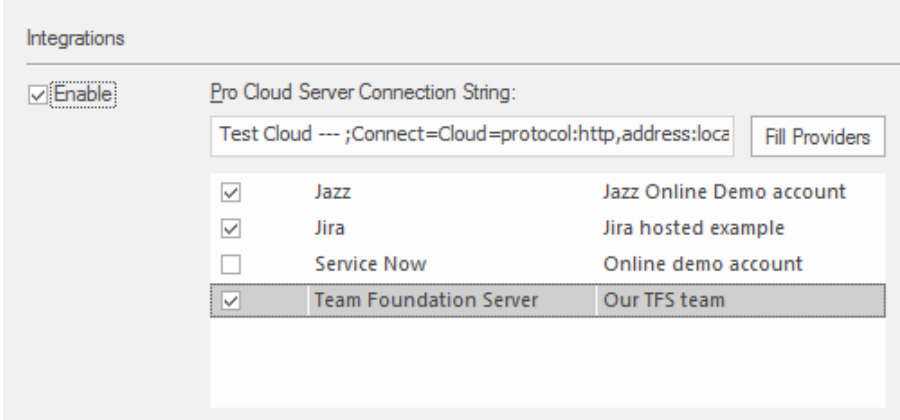
	<p>initial diagram image and image map for each diagram and an initial HTML page for each Linked Document.</p> <p>You should only need to do this occasionally, to force a wholesale update of the cache; normally the individual diagram images and Linked Document pages are updated automatically when the original object is changed.</p>
<p>Integrations</p>	<p>It is possible to connect a non-Cloud model to the Integration Plug-ins provided by Pro Cloud Server.</p>  <p>To enable this feature:</p> <ul style="list-style-type: none"> • Tick the 'Enable' check -box • Enter a connection string to a Pro Cloud Server (it is not necessary to include a 'Data Source' or 'DNS') • Click on the Fill Providers button to populate the list of available external data providers • Tick any providers that should be made

	<p>available to this model</p> <p>Note: The connection string for a Cloud connection can be obtained via the Manage Project window, by right-clicking on a recent connection and selecting 'Edit connection string'.</p>
Prolaborate URL	Type the fully qualified URL (including protocol, server name or IP) and Repository ID

Notes

- In the Corporate, Unified and Ultimate Editions of Enterprise Architect, if security is enabled you must have 'Manage Project Settings' permission to set 'Auto create Diagram Image and Image Map' and the WebEA URL and model number

Translate Page

Enterprise Architect provides a number of facilities to translate text that has been entered into the Notes window by users. To set up the parameters for translating Notes text from its current language to another, you use the 'Translations' page of the 'Manage Model Options' dialog. This page allows you to enable the Translation facility and identifies the automatic Translator tool, whether to translate text automatically and whether the translated text can be edited or not.

When you have finished configuring the Translation parameters, restart Enterprise Architect to put them into effect. You can then begin translating text as explained in the *Translation Facilities* and *Text Translation* Help topics.

Access

Ribbon	Settings > Model > Options > Translate
--------	--

Configure Translation Options

Option	Description
Enable	Select this checkbox to enable the

	<p>automatic translation facilities and open the fields for data entry. If you are restricted to performing manual translations (in the Professional Edition) or if the translation Plug-in is otherwise not installed or turned on, this checkbox is unavailable, as are the next five fields.</p>
<p>Translator</p>	<p>Select (from the drop-down list) the internet translation facility you are subscribing to, either Microsoft or Google. If you intend to only perform manual translations, select the 'Manual' option.</p>
<p>Auto translate notes</p>	<p>Select this checkbox if you want to translate the Notes text immediately and automatically whenever the 'Translation' tab of the Notes window is accessed. Deselect the checkbox to perform the translation only when you specifically select the 'Force Translate' option in the Notes window.</p> <p>Bear in mind that your translator subscription might impose restrictions on the number or size of requested translations, so you might prefer to deselect this option until you have seen how much translation you actually</p>

	perform.
Allow editing of translated notes	<p>Select this checkbox to enable you to make changes to the translated text in the Notes window. Deselect the checkbox to block manual changes to the translated text.</p> <p>If you make manual changes to the translated text, the local Notes text is protected against automatic translation but can be force-translated.</p>
Registration tag	Type in the registration tag for the internet translator subscription (if necessary).
Registration key	Type in the registration key for the internet translator subscription.
Primary Language	Click on the drop-down arrow and select the source language, in which you normally type text into the Notes window. This is passed to the translation facility as the defined source language.
Supported Languages	Select the checkbox against each language that you want to be available for selection in the Notes window, into which to translate the text from the

	source language. These languages will be presented in a drop-down list on the 'Translation' tab of the Notes window.
Close	Click on this button to save your changes, if you have finished setting project options.

Notes

- You can perform manual translations in any Edition of Enterprise Architect; to perform automatic translations you require Pro Cloud Server release 4.1, in a Corporate, Unified or Ultimate Edition of Enterprise Architect
- You can create a translation model to define terms (as elements) that either should not be translated or should only be translated as a specific text string; the model is checked and the element-defined terms protected before the text is passed to the translator

Collaboration Page

This page helps the Database Administrator to link the current model to a common model for communicating information amongst project members who are working in different projects. In the 'Model Connection' field, you enter the connection string for the model that is providing the central Collaboration facilities (Model Mail, Calendar, Chat and Diary) for users of the current model.

Access

Ribbon	Settings > Model > Options > Collaboration
--------	--

The Model Connection Field

Click on the  button to display options to connect to the Cloud or remove the current value from the field.

- If you click on 'Define Connection' the 'Cloud Connection' dialog displays with the fields defaulted to the first Cloud-connected model in the 'Pinned' or 'Recent' list; if necessary, select or overtype with the appropriate replacement values, and click on the OK button to display the model name in the 'Model Connection' field
The current model will then link to the Collaboration

facilities of the connected model

- If you click on 'Remove', any connection string is removed from the 'Model Connection' field; once the current model is reloaded, the model users will then revert to the Collaboration facilities of that model - all the original Collaboration content is available

Notes

- You must have 'Administer Database' access permissions to set the central model
- The end users must have the same user credentials in both the 'work' model and the 'Collaboration' model (and therefore User Security has to be enabled in both models)
- You can set up the user credentials the same way in each model, but if you are using a MySQL, SQL Server or Oracle repository it is far more convenient for you as Database Administrator to set up a shared repository for both models so that they refer to the same *secusers* table (the *secusers* table is one of those listed for selection when setting up a shared repository)

Review Status Locks Page

When a review is being performed on an element, a point will be reached when input and comments have been made, perhaps changes also made, and the Reviewer Managers need to consider the current situation before asking for more comment. Alternatively, the review of that element is complete and no further input is required. In either case, you can lock the element under review against the posting of any further discussion topics or responses. To do this, you identify one or more element status values that, if an element has that status, will lock the review.

Access

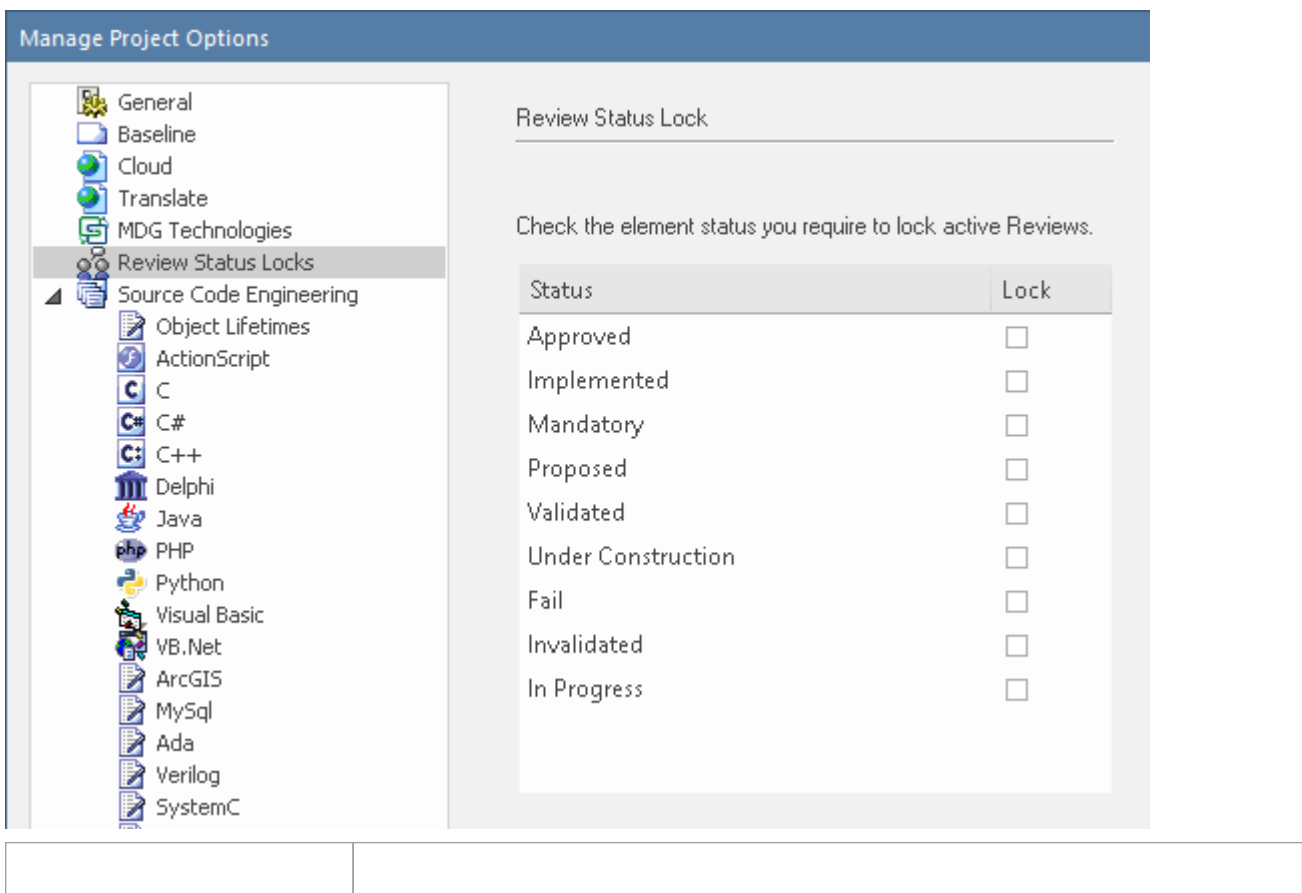

Ribbon	<p>Settings > Model > Options Review Status Locks</p> <p>Start > Collaborate > Review Manage Reviews Right-click on a Review (left hand side) or element (right hand side) Review Status Locks</p> <p>Start > Collaborate > Review Review :  Review Status Locks</p>
--------	---

Set Locking Status

Simply select the checkbox against each status that will lock the element against any further review postings, then click on the Close button.

The status values offered are drawn from the list defined on the 'Status' page of the 'General Types' dialog (Settings > Reference Data > Model Types > General Types > Status).

Model Glossary

Glossaries can be modeled in a number of different ways depending on the formality of your modeling approach; each method allows you to create a lexicon of important project terms and their meanings. You can model the terms as a simple list with the terms, their categories and their meaning entered in rows in a table, using a dialog or window.

Alternatively, the terms can be created as modeled elements, which provides more flexibility and a number of additional features. Both of these approaches has its uses and either will assist in reducing the ambiguity and uncertainty that arises in project work. Regardless of the method chosen, the defined terms will appear in the Glossary View.

Importantly, when the terms are included in textual descriptions such as the notes of other elements, they can be de-referenced to clarify the meaning, with both the category and meaning being displayed in a tool-tip when you roll-over the term in the text.

Using the list approach, where terms are entered through the Glossary dialog, the important terms can be easily defined along with their meaning. A user can set up any number of *Types* that can be used to group the terms into lexical sets which can be defined for any purpose; for example, types could be defined for each project, program, department, discipline or any user defined group.

Using the modeled approach Glossary terms can be modeled as first class citizens, allowing rich models of terms and their definitions to be created. Packages stereotyped as

Glossary Category are used to group Glossary Entries into lexical sets. The glossary category Packages and the terms - like any other modeled element - will appear in the Browser window and can be included in diagrams.

Rich networks of interrelated terms can be created describing the semantic and lexical relationships between terms, and each term can have descriptive properties defined. These properties can be built-in or user defined using Tagged Values. For example, you might be working on projects in the health sector and define a term 'Admission Process' and relate it to another term 'Health Facility', each term could have a status (built-in) or a business owner or custodian (user-defined). When publications are generated from the repository, the terms that form part of a specific Glossary Category can be styled (marked up) allowing them to be identified in the publication as belonging to the same lexical set.

This method allows any number of glossaries and categories to be created for different purposes, such as the terms that belong to a particular discipline - say, 'Regional Health Care' terms - or that are part of a specific standard - say, 'Business Process Modeling terms - or are from a given business or technical domain such as 'Foreign Exchange', 'Agile Development' or 'Artificial Intelligence'.

The glossaries, their categories and the terms they contain can be conveniently shared or exchanged between any repositories.

Access

Ribbon	Design > Dictionary > Glossary
--------	--------------------------------

Project Glossary functionality

Tasks
Add, delete and modify the Project Glossary entries through either the: <ul style="list-style-type: none">• Glossary View, or• 'Glossary' dialog
Separate glossary items by type; for example, Business terms and Technical terms.
Create a Glossary as a Model Package Structure.
Define Markup Styles to apply to terms of specific types where they occur in generated document reports.
Save the glossary in Rich Text format for inclusion as part of a larger project document.
Create glossary terms and definitions from text in the Notes window, or from any 'Notes' or 'Description' fields

that have the Notes toolbar.

Insert existing glossary terms into any other 'Notes' fields.

Notes

- In the Corporate, Unified and Ultimate Editions of Enterprise Architect, if security is enabled you must have 'Manage Glossary' permission in order to create, update or delete Glossary items; if security is not enabled, you can manage Glossary items without any permissions
- You might include a Glossary Report in your project requirements or functional specifications documents
- You can transport glossary definitions and glossary style mark-ups between models, using the 'Settings > Model > Transfer > Export Reference Data' and 'Import Reference Data' ribbon options

Project Glossary View

The Model, or Project, Glossary consists of a list of defined terms for your project, as displayed in the Project Glossary View.

You can create Glossary items to define terms in two ways:

- Through the 'Glossary' dialog as text-based entries or
- As elements in a model structure, grouped under Glossary Category Packages

The Project Glossary View provides options to review the terms of different types already defined for a model. It identifies which Glossary items are defined as model elements, and therefore those that are not will be entries created in the 'Glossary' dialog. You can use the Project Glossary View to:

- Add glossary terms (via the 'Glossary Detail' dialog, not as a model element)
- Assign a Markup Style to a glossary term Type or Category, to print in a documentation report any terms of that Type/Category in that style
- Modify glossary terms
- Filter the display to show terms of a specific Type or Category only
- Change a definition Type for all terms of that Type
- Print the displayed list of terms
- Delete glossary terms (those defined via the 'Glossary' dialog, not those created as model elements)

From the View you can also select, copy and paste (Ctrl+C and Ctrl+V) some or all of your Glossary entries to an external text editor or spreadsheet tool. The text is copied in CSV format.

Access

Use one of the methods described in the table, to display the Glossary view.

Ribbon	Design > Dictionary > Glossary > Glossary View
--------	--

Glossary View Options

Within the Glossary view, right-click on an entry and select the appropriate option for the operation you intend to perform (as listed); if you select the:

- 'Add New' option, the 'Glossary Detail' dialog displays; complete the fields as indicated in the *Glossary Detail Dialog Fields* table
- 'Assign Markup Styles' option, the 'Glossary Markup' dialog displays on which you assign display styles to terms of each existing term Type or Category; the style is applied when you generate an RTF report containing the glossary terms (see the *Glossary Styles* Help topic)
- 'Modify Selected' option, either the element 'Properties' dialog (for model element terms) or 'Glossary Detail'

dialog displays, in which you can edit the name and/or definition of the term

- 'Field Chooser' option, the 'Field Chooser' dialog displays, from which you can drag any column headings not currently displayed into position in the heading row; to return a header to the dialog, simply drag it out of the heading row (see the *List Header* Help topic)
- 'Enable Group Box' option, the Group Box is displayed above the header row, in which you reorganize the list to group the entries according to one or more properties (see the *List Header* Help topic)
- 'Toggle Filter Bar' - a row of fields displays below the header row, in which you can type values to display only those items that contain that value in the property shown in that column (see the *List Header* Help topic)
- 'Rename Type' option (not available for model element glossary terms), the 'Rename Glossary Type' dialog displays on which you type in or select the alternative Type name (either another of the existing Types or a new Type); when you click on the OK button, all entries of the original Type are changed to the new Type
- 'Set term filter' option, the 'Term Type Filter' dialog displays on which you enter the Type or Category of glossary term to list; when you click on the OK button, only items of that Type are shown on the Glossary view
- 'Remove term filter' option, the Glossary view refreshes to show glossary items of all Types
- 'Print List' option, the 'Print' dialog displays on which you

define the printing parameters; when you click on the OK button, the currently-displayed list prints out

- 'Find in Project Browser' option (only for model element glossary terms) the system locates and highlights the element that defines the term in the Browser window
- 'Reload' option, the Glossary view refreshes to capture any new glossary elements that might have been created since the view was displayed
- 'Delete' option (not available for model element glossary entries), a prompt displays to confirm the deletion; click on the Yes button to remove the term from the Glossary

Glossary Detail Dialog Fields

Field	Action
Term	(Mandatory) Type the term to include in the glossary.
Type	<p>(Mandatory) Select the required Type. If you require a different glossary Type, click on the <input type="button" value="..."/> button and specify the name of the new Type.</p> <p>This field applies the Type only to the selected term; you can rename a Type for all terms of that Type, using the context menu.</p>

	Further discussion of the 'Type' field is provided in <i>The Glossary Dialog</i> Help topic.
Meaning	Type the definition or description of the term. If necessary, format the text of this description using the Notes toolbar at the top of the field.
New	Clear the dialog fields so that you can define a new Glossary term.
Apply	Save the new or updated glossary entry.
Delete	Delete the entry. A prompt displays to confirm the deletion; click on the Yes button to remove the term from the glossary.

Notes

- In the Corporate, Unified and Ultimate Editions of Enterprise Architect, if security is enabled you must have 'Manage Glossary' permission in order to create, update or delete Glossary items; if security is not enabled, you can manage Glossary items without any permissions

The Glossary Dialog

Using the 'Glossary' dialog, you can create, maintain and delete definitions of terms used in your project, as a Glossary. When reviewing the Glossary terms, you can filter the list to display terms of a specific Type.

The term Type also acts as a key for substituting the description of any term of that Type for the term itself, so that in a report the terms 'Corp', 'Uni' and 'Ult' would be replaced by the descriptions 'Corporate', 'Unified' and 'Ultimate', respectively.

Access

Ribbon	Design > Dictionary > Glossary > Edit
--------	---------------------------------------

Maintain Glossary Terms

Field	Action
Glossary Term	Type the term to include in the glossary.
Glossary Type	(Mandatory) Every Glossary term must be assigned to a Type, so that you can:

- Filter terms by Type
- Search for terms of specific Type
- Assign a format and style to terms of a Type to indicate that a glossary definition has been attached to a word in the text; terms of different Types would be distinguished by their respective styles
- Replace all terms of a specific Type with the text string in their 'Description' field (see the *Substituting Descriptions for Terms* section later in this topic)

When you first start to create a Glossary, there are no Types defined in your model. You create the Types that are most appropriate to your work environment, by clicking on the  button and, on the 'New Glossary Type' prompt, entering the name of the new Type. The names that you invent for the Types would be whatever is meaningful to the people compiling and using the Glossary.

In the simplest of Glossaries you might have just one Type, simply to assign a style to it so that terms are identified as being defined in the Glossary. In larger, more complex Glossaries you might have different Types to group - for example - Business terms, System terms and

	<p>Project-Specific terms.</p> <p>When the Types you require have been created, and you are defining a term, click on the drop-down arrow and select the appropriate Type.</p> <p>This field applies the Type only to the selected term; you can rename a Type for <i>all</i> terms of that Type using the Glossary view.</p>
Description	<p>(Mandatory) Type the definition or description of the term.</p> <p>If necessary, format the text of this description using the Notes toolbar at the top of the field.</p>
Limit Display To	<p>Click on the drop-down arrow and select the appropriate glossary type to filter the 'Type Term' list and show entries of that type only.</p> <p>Select the '<All>' option to display all glossary entries.</p>
New	<p>Click on this button to clear the dialog fields so that you can define a new Glossary term.</p>
Type Term	<p>Review the list of defined glossary terms; click on an entry to edit it in the dialog</p>

	fields.
Save	Click on this button to save the new or updated glossary entry.
Delete	Click on this button to delete the entry selected from the 'Type Term' list.
Report	Click on this button to generate and print a Glossary Report.

Substituting Descriptions for Terms

You can use the Type of Glossary entries to replace all terms of that Type in a report with the text string in the 'Description' field for each term. For example, you might define a Type of 'Abbreviation' and use that Type for a number of terms such as Co, Bus and Corp, with the respective descriptions of Company, Business and Corporation; when you generate a report, the text Co, Bus and Corp will be replaced with the corresponding description.

You apply the glossary term substitution through the 'Generate Documentation' dialog - select the 'Publish > Model Reports > Report Builder > Generate Documentation' ribbon option - as described in the *Generate Documentation* Help topic. (This is separate from generating a report on the Glossary itself.)

1. On the 'Generate' page, select the 'Markup Glossary Terms' checkbox
2. In the 'Use Glossary Substitution' field, click on the drop-down arrow and select the term Type. (You can only substitute for terms of one Type at a time.)

When you generate the report, for all glossary terms of the specified Type, wherever a term occurs in the report it will be replaced by its description.

You should not set up term substitution in a model from which you generate only HTML reports; the HTML report generator does not substitute descriptions.

Notes

- In the Corporate, Unified and Ultimate Editions of Enterprise Architect, if security is enabled you must have 'Manage Glossary' permission in order to create, update or delete Glossary items; if security is not enabled, you can manage Glossary items without any permissions

Create a Glossary as a Package Structure

Using the modeling approach to defining glossaries provides great flexibility and additional features not available in the dialog-list approach. In this approach the glossary, the categories and the terms themselves are modeled as first-class citizens. This allows the categories and the terms to be located in the Browser window and visualized in diagrams, and for the terms to participate in relationships that model their semantic and lexical connections. The terms can have additional properties defined, such as an alias or status, or any user-defined property such as Custodian. Hyperlinks can also be added that target an online resource used to define or clarify the term, and discussions can be posted to facilitate the collaboration needed to ensure all stakeholders agree on the term's name and meaning. Governance and fine-grained control of the creation and update of the Glossary content can be added down to a term level, using the Package and element locking feature in conjunction with model security.

You can define your Project Glossary using a model structure in which the Glossary itself is represented by a Package, and each type of term (such as Business terms or Technical terms) is represented by a child Glossary Category Package containing Glossary Entry elements that define the terms. The structure resembles this illustration:

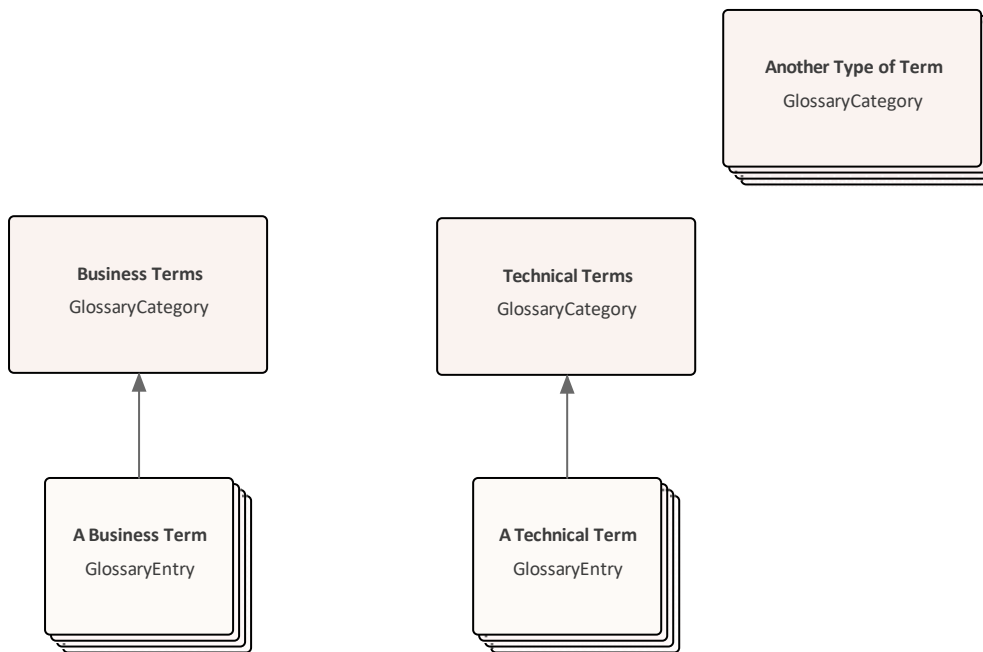

The Glossary Package is an optional convenience to collate Glossary content - the Glossary loader searches for and acts on the Category Packages which, with their Entry elements, can actually live anywhere in the model.

Anything you create or edit in the structure becomes active after you reload the Glossary. That is, a term defined in the Glossary is underlined and, when you move the cursor over it, the term, category and definition display in either a pop-up text box beside the term or at the bottom left of the screen in the Status Bar (depending on which location you have set in the 'Window Behavior' page of the 'Preferences' dialog).

The advantages of using this method are:

- You can set up the structure to create a functional Glossary very quickly
- It is extremely easy to add, change and remove categories of term, either on a diagram or in the Browser window

- You have great versatility in categorizing and changing the categories of defined terms
- The ease and speed with which you can add and edit term descriptions and definitions
- Glossary terms can be connected together to define semantic and lexical relationships
- Security can be set at any level to apply governance and federated control on the terms
- Discussions can be posted to assist with definition and clarification of the terms' meanings
- Built-in or user-defined Properties can be added to the terms used to define meta-level information such as status, alias, the business or technical custodian and more

The same modeling principles are used to manage translation of the text you enter in Enterprise Architect; see the *Create a Translation Glossary Model* Help topic.

This feature is available in Enterprise Architect from Release 15.1 onwards.

Set up the Glossary Model

1. The first stage in setting up your Glossary model is to locate or create the parent Package for the Glossary. This could be directly as a Root Node, a View, a Model Package (created from the Model Builder) or one or more simple Packages. Your choice depends on how you want the Glossary structure to sit within your overall Project.

The simplest and most structured method is to create a

model using the Model Builder.

1. In the Browser window, click on the host Root Node, View or Package for the Glossary (perhaps within an Administration or Resources section of your project).
2. Click on the  icon in the Browser window toolbar. The Model Builder dialog is displayed.
3. Click on the <perspective name> button just underneath the tab name, and select 'Publishing | Glossary'. The Glossary Perspective patterns list displays, providing a number of options that are described later in this topic; for this process click on 'Structured Model Glossary Template'.

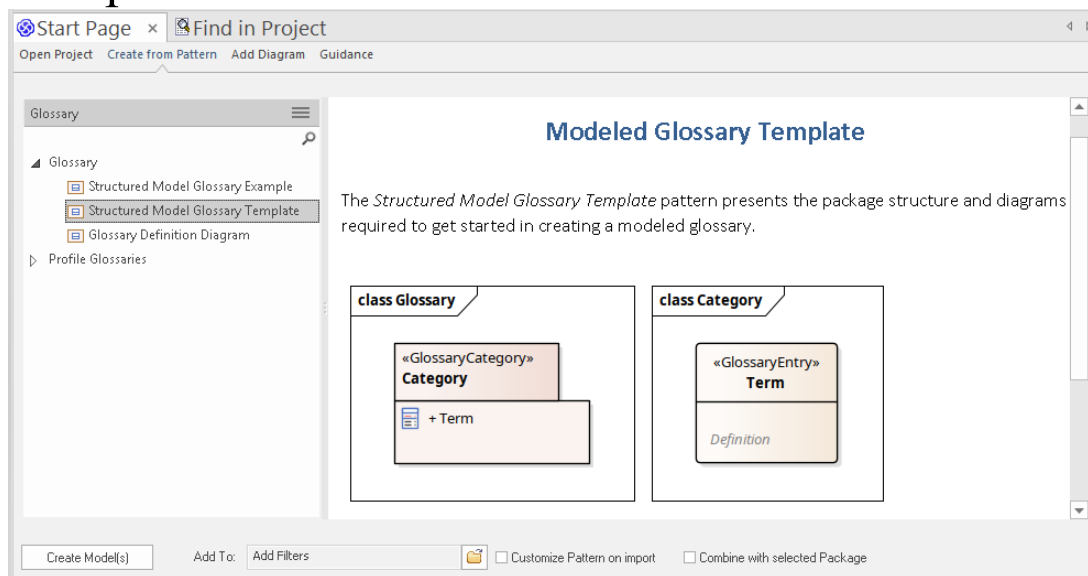

4. Click on the Create Model button. A Glossary Package is added to the Browser window under the host Package, containing a Glossary diagram and a <<GlossaryCategory>> Package, which in turn contains a Category diagram and a <<GlossaryEntry>> element.

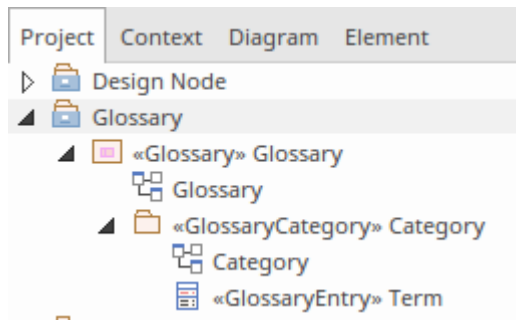

5. In the Browser window, click on the <<GlossaryCategory> Package and, using the Properties window (press Ctrl+2 if it is not open), change the name to represent the first of your glossary categories, such as 'Business Terms'. Do the same thing with the name of the diagram in the <<GlossaryCategory>> Package.
6. In the Browser window, click on the <<GlossaryEntry>> element and change the name to the first of the glossary terms in the current Glossary Category; for example, 'BPMN'.
7. In the Notes window for the element (press Ctrl+3 if the window is not open) type the description or definition of the term.

You now have the structure of the Glossary model with one term definition in one of the term categories.

Right-click on the name of any GlossaryCategory Package or GlossaryEntry element in the Browser window and select the 'Reload Glossary' option. Choose an object in the model and type your term in the Notes window, then move the cursor over that term. You will see the term description or definition in either a pop-up text box or the Status Bar, as defined in the 'Preferences' dialog.

If the description is too long to display in the initial location,

press Ctrl and click the left mouse button to display the Project Glossary View. This shows the details of all Glossary items, including the definition of each item.

If a term has more than one definition (as might occur with multiple technologies and/or pre-defined text translations) all definitions are shown in the tool-tip, although they are listed as separate items in the Project Glossary View.

Add Categories and Terms to the Model

Having set up the basic structure of the Glossary model, you can create further categories and add terms to each category.

Your first step is to double-click on the Glossary diagram name in the Browser window, to open it. You will see that it contains the initial <<GlossaryCategory>> Package element, itself listing the first <<GlossaryEntry> element.

The Diagram Toolbox will also open at the 'Glossary' page, containing the Glossary Category icon.

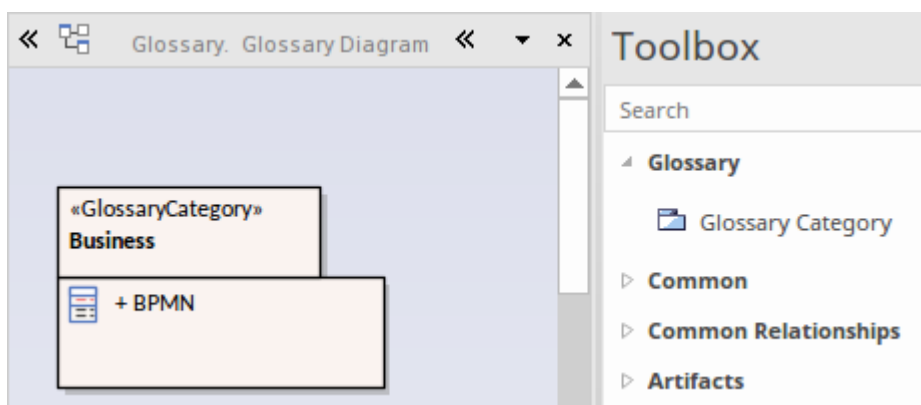

1. For each Glossary Category you want to group terms and definitions under, drag the Glossary Category icon from the Toolbox onto the diagram and provide a name for it, such as 'Technical', 'HR' or 'Management'. A

<<GlossaryCategory>> Package is created on the diagram and in the model.

2. Save the diagram.

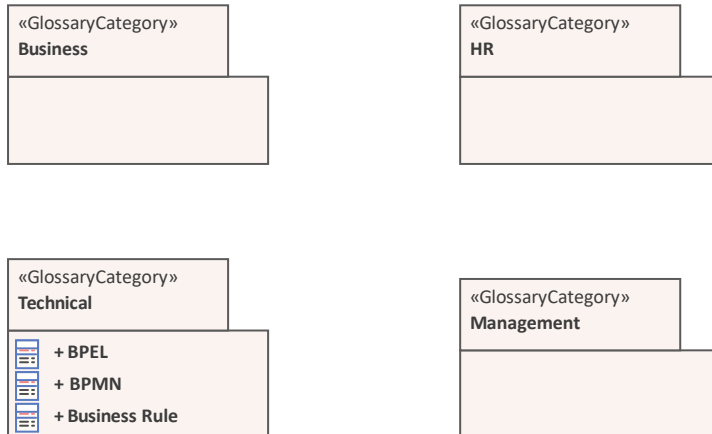

You can now add Glossary Terms to each of the categories. This is one method - you can also add the Glossary Entry elements via other windows and views, and directly through the Browser window. See the *Create Elements* Help topic.

1. Double-click on the first Category Package under which to define some terms. A new diagram opens with the same name as the Category, and the Toolbox displays the 'Category' page, containing the Glossary Entry icon.
2. For each term you want to define in this category, drag the Glossary Entry icon onto the diagram. A <<GlossaryEntry>> element is created on the diagram and in the model.
3. Double-click on the element and, in the 'Properties' dialog, type the term being defined in the 'Name' field and the definition of the term in the 'Notes' panel. Click on the OK button. You begin to build up the set of Glossary terms relevant to the category.

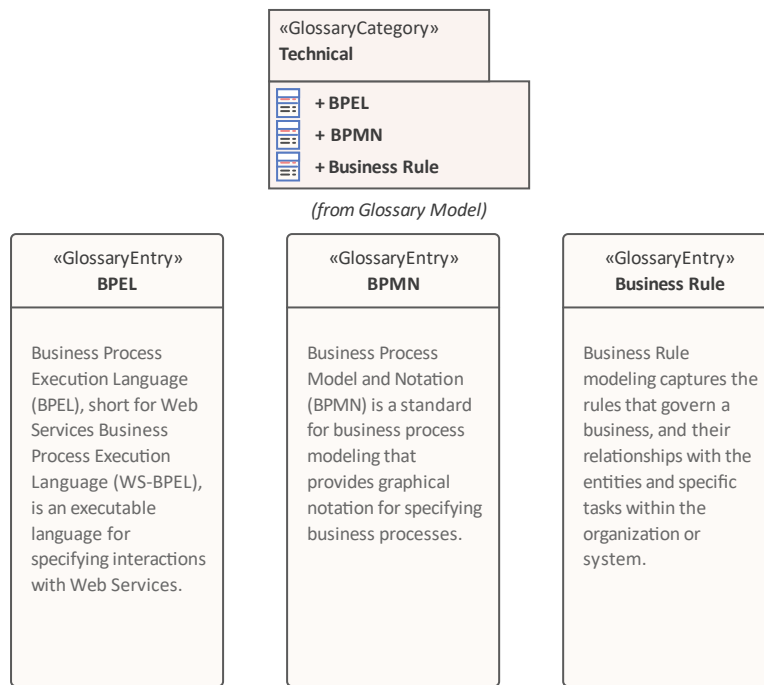

Again, save the diagrams, right-click on the name of any GlossaryCategory Package or GlossaryEntry element and select the 'Reload Glossary' option to activate the new terms in the Glossary of the model.

Create a Domain-Specific Glossary

You can create a number of types of Glossary to suit your requirements, either under one overall Glossary Package or dispersed under separate context-Glossary Packages, or even as individual GlossaryCategory Packages. One example of a glossary type is the natural language Translation model, which is discussed in the *Create a Translation Glossary Model* Help topic. Others include Glossaries specific to, say, individual modeling languages or development domains.

You can create domain-specific glossaries from scratch. However, Enterprise Architect provides patterns to help you

load a number of ready-made domain glossaries. To see those available, on the Model Builder dialog, click on the <perspective name> button, select 'All Perspectives' and set the filter field directly underneath it to 'Glossary'.

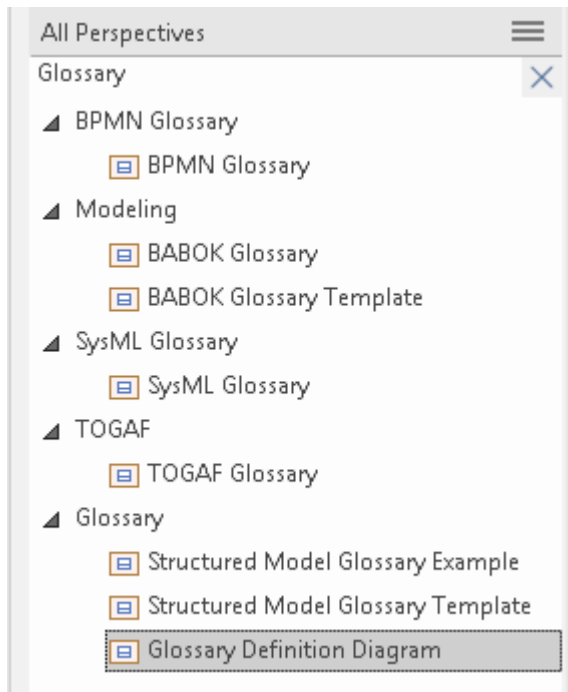

Amongst the patterns listed you will see those for glossaries of BPMN terms, SysML terms, BABOK terms and TOGAF terms. You can simply create glossaries directly from these patterns and - if necessary - add to or edit the term definitions. If a pattern does not exist for your required modeling language or domain, you could use one of the listed patterns and more radically edit the resulting glossary to adapt it to your language or domain.

Create an Ad-Hoc Glossary

Whether you have a structured glossary model or not, you might find that you need to define or capture a set of terms quickly, or without any real consideration for what specific

category they might belong to. For example, you might have a solid glossary for SysML but decide to define a number of more general MBSE terms or more localized company jargon terms.

In these contexts, you can use the Glossary Definition Diagram pattern to create an empty diagram in which you can create GlossaryEntry elements or into which you can drag any other type of existing element from the Browser window. The only things to consider are:

- The diagram name should indicate some relationship with the glossary, such as 'Unassigned Glossary Terms'
- The element name should represent the term and
- The element notes should provide an appropriate definition or description of the term

Once the elements are on the diagram, just right-click on the name of any GlossaryCategory Package or GlossaryEntry element and select the 'Reload Glossary' option. The element names and notes text are added to the glossary, and when you mouse-over the term in text, the definition displays preceded by the diagram name, identifying where the definition is held.

Notes

- In the Corporate, Unified and Ultimate Editions of Enterprise Architect, if security is enabled you must have 'Manage Glossary' permission in order to create, update or delete Glossary Categories and Entries; if security is not

enabled, you can manage Glossary items without any permissions

- Glossary Categories defined as Packages in the model are not offered as 'Type' options in the 'Glossary Detail' dialog; to assign dialog items to the same category as model items, you have to specify the category as a new type in the dialog (click on the  icon at the end of the 'Type' field)
- In the Project Glossary View the items created as model elements (Model Item = True) have different context menu options to those generated through the 'Glossary Detail' dialog; for example, you cannot add or delete Model Items in the Project Glossary View

Create a Translation Glossary Model

A Translation Glossary model is a variant of your overall Glossary model. If you are not yet familiar with the structure of a Glossary model, see the *Create a Glossary as a Package Structure* Help topic.

The Translation model is a reference for the automatic Translation facilities. The model defines terms that should not be translated (such as product names) or terms that should be translated to a specific word or phrase, either whenever it is encountered or when a specific instance of the term is flagged. The automatic Translation facilities check the model and substitute and protect the defined terms in the Notes text before calling the Google, Windows or custom translator to freely translate the rest of the Notes content.

Like the elements of the overall Glossary, the Translation model elements also show the 'meaning' of the term - any specific translation of the term in each configured language, or a block against translation - in the in-text pop-up messages, Status bar messages and Project Glossary View entries. You can therefore check what is defined for a term by moving the cursor over it.

The Translation GlossaryCategory Packages can be children of a top-level Glossary Package, their own <language>-Glossary Packages or any other convenient Package in the model. You would typically have a global translation category (primarily for terms that are not to be translated), a category for each configured language, such as

French, German and Chinese, and one or more categories for 'special use' terms that have defined translations only in certain contexts - such as when used in a menu path. The translation facilities are already configured to check the language-specific categories, but when you flag a 'special use' term a prompt displays for you to specify which category contains the translation to use.

An overall Glossary model with translation categories might have this organization:

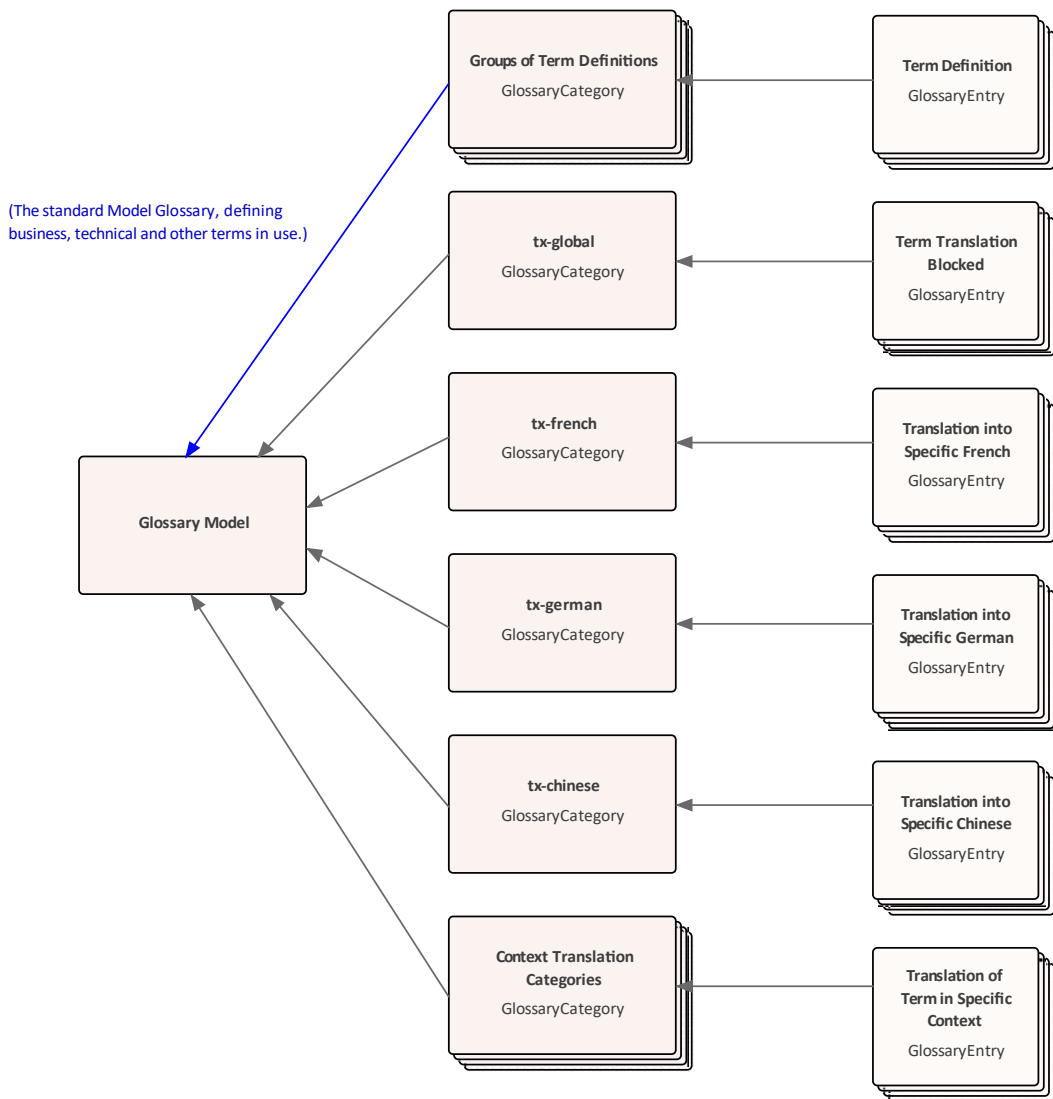

Set up the Translation Model

Locate or create the parent Package for the translation GlossaryCategory Packages (such as an overall Glossary Package - see the *Create a Glossary as a Package Structure* Help topic.)

The Glossary diagram for translations will contain GlossaryCategory elements for the global translation process, for each language your project team will translate text into, and at least one 'special case' where words in one context must be translated differently from the same words in a different context. You therefore need to plan what categories you require, especially the types of special case you might need to prepare for. For each language translation Package, give the Package the name *tx-`<language>`*; for example, *tx-french*. An overall Glossary model content, as it is being developed, might resemble this example:

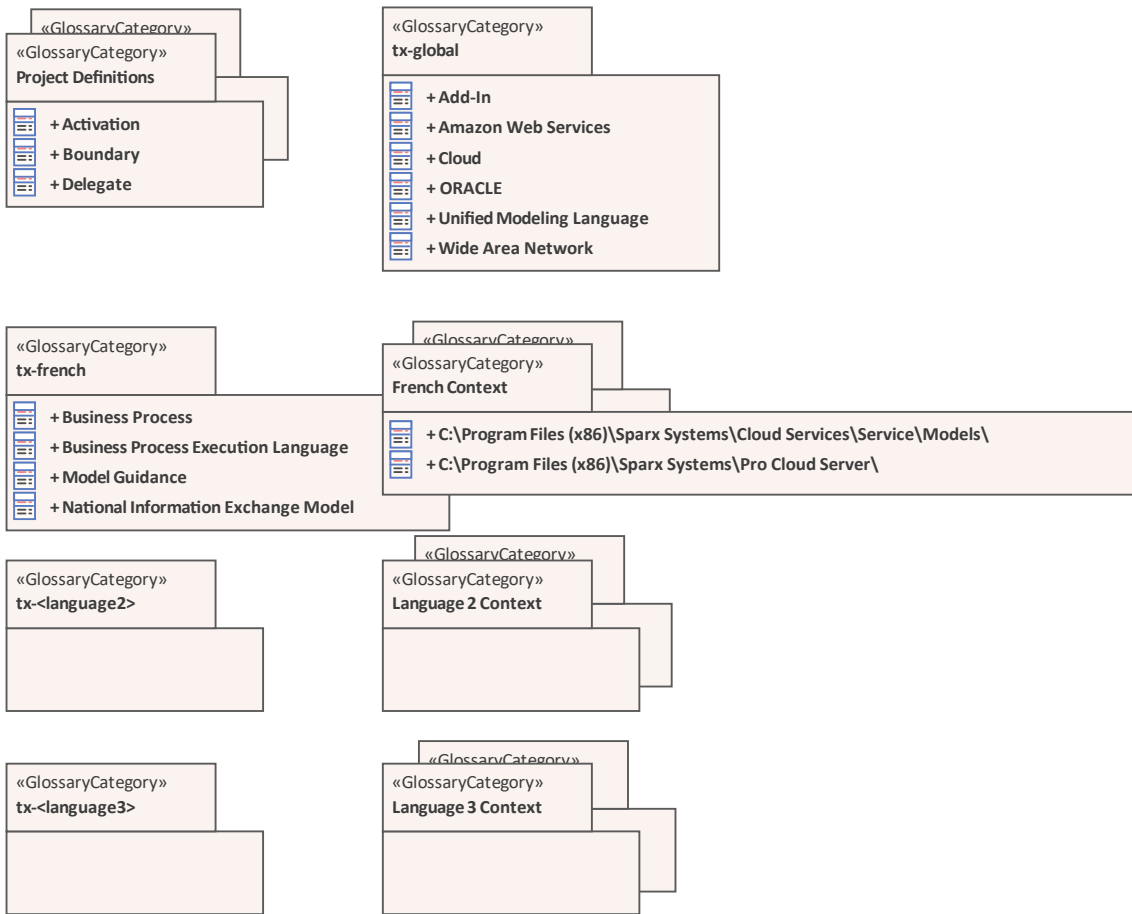

Each GlossaryCategory Package will have its own GlossaryCategory diagram, to which you add GlossaryEntry elements. A GlossaryEntry element defines how a text string or term (the name of the element) is processed in translation - whether it is blocked against translation or whether it is pre-set with a specific translation in the corresponding language and/or under a certain condition. You therefore also need to consider what terms you will use that require special treatment in the translation process. A GlossaryCategory diagram might resemble this example:

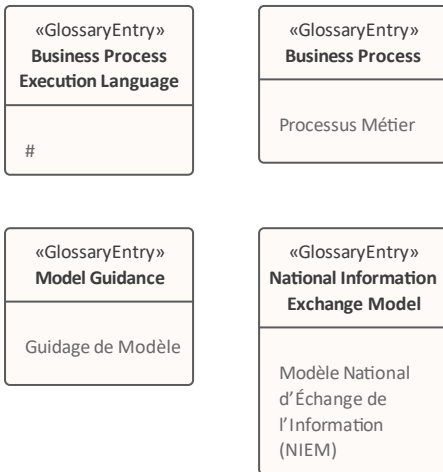

If you want to block the translation of a term, type a hash (#) as the complete notes text for the element, as shown for the Business Process Execution Language element in the diagram. If you want to provide a specific translation of the term, type that translation into the notes text as shown for the other elements in the diagram.

Glossary Styles

When you are defining your Glossary terms, you can also define a documentation style to apply to terms of a specific Term Type. When you generate RTF, PDF or DOCX documents those terms are shown in the defined color, font and/or emphasis. This applies a visual key to the Glossary terms of each Type, and makes it easier for the reader to recognize all the terms for which they can obtain a definition or explanation.

You apply the glossary styles through the 'Generate Documentation' dialog (as described in the *Generate Documentation* Help topic). You should not set up glossary styles in a model from which you generate only HTML reports; the HTML report generator does not apply glossary styles.

Configure Glossary Styles

You configure Glossary styles within a Glossary Style Sheet, using the 'Glossary Markup' dialog; you display this dialog from the Glossary View. For each Glossary Term Type, you define one style in the Style Sheet, using the standard CSS style definition language. This is an example of two style definitions in a style sheet:

```
.paragraph {  
    font-family: courier;
```

```
font-size: 16px;
font-weight: italic;
color: #FF0000;
background: none;
text-transform: capitalize;
}
.language-term {
font-family: arial;
font-size: 14px;
font-weight: bold;
color: #800000;
background: none;
text-transform: capitalize;
}
```

Access

Ribbon	Design > Dictionary > Glossary > Glossary View > Right-click > Assign Markup Styles
--------	---

Define Styles

Assign one style to each of the Glossary Term Types, which have been defined on the 'Glossary' dialog.

Option	Action
Term	This column lists the existing Term Types in the Glossary.
Style Name	<p>This column identifies the style assigned to each Term Type. If no style has been assigned, the field is blank.</p> <p>To assign or switch the style, double-click on the row, type the style name on the 'Input' prompt and click on the OK button. If the name contains more than one word, link the words with hyphens.</p> <p>The new style name is added to the top of the 'CSS' panel.</p>
CSS	<p>Between the parentheses under the style name, type in or copy/paste the new style definition, or edit an existing definition. The styles are created one after another within the single style sheet for the Glossary.</p>
OK	Click on this button to save changes to the style definitions and close the dialog.

Using Glossary Styles

You use Glossary Styles to identify and highlight Glossary terms in your printable reports, and to indicate what kinds of term they might be. You can also use the terms as place-holders for more complex text strings in the term definitions, so that the report generator substitutes the text string for the place-holder term. Both text formatting and text substitution are enabled by selecting options on the 'Generate Documentation' dialog (click on a Package or element and press F8).

Configure Reporting for Glossary Styles

You can apply glossary styles to your RTF, PDF or DOCX documentation through the 'Generate Documentation' dialog (select 'Publish > Model Reports > Report Builder > Generate Documentation').

Task	Action
Using the Markup Style	Select the Markup Glossary Terms checkbox to apply, in the generated report, any styles applied to any Glossary terms through the 'Notes' text of an element. A style is applied to a Glossary term according to its Glossary Term Type.

Notes

- You can copy the Glossary Style Sheet between models as reference data, using the 'Settings > Model > Transfer > Export Reference Data' and 'Import Reference Data' ribbon options

Generate a Report

You can generate a rich text format (RTF) file of your model's glossary, which you can either print or attach to any other appropriate document file.

The file can contain all glossary entries, or just those of selected Types.

Access

Ribbon	Design > Dictionary > Glossary > Edit : Report
--------	--

Generate an RTF report of the Project Glossary

Step	Action
1	In the 'Filename' field, type or select a filename for the glossary.
2	In the 'Heading' field, type a suitable heading for the glossary.

3	In the 'Include Glossary Items' panel, select the checkbox for each type of glossary entry to include. To select all types of entry, click on the Select All button.
4	If necessary, to define the page setup for the report, click on the Page Setup button and complete the 'Page Setup' dialog.
5	If you want to substitute certain system-defined words for others that might be more meaningful to your readers, or print the whole report in another language, click on the Language button and define your output on the 'Customize RTF Language' dialog.
6	To include page breaks, select the 'Page break between sections' checkbox.
7	Click on the Generate button to generate the report.
8	Click on the View button to open the report.

Glossary Report Output Sample

An example of the output from a Glossary report is shown here:

Glossary

Business Terms

Accounting Periods

A defined period of time whereby performance reports can be extracted (normally 4 week periods).

Customer

A person or a company that requests an entity to transport goods on their behalf.

Technical Terms

Association

A relationship between two or more entities. Implies a connection of some type - for example, one entity uses the services of another, or one entity is connected to another over a network link.

Component Model

The component model provides a detailed view of the various hardware and software components that make up the proposed system. It shows both where these components reside and how they inter-relate with other components. Component requirements detail what responsibilities a component has to supply functionality or behavior within the system.

Deployment Model

A model of the system as it is physically deployed.

Extends Relationship

A relationship between two Use Cases in which one Use Case 'extends' the behavior of another. Typically this represents optional behavior in a Use Case scenario - for example a user might optionally request a list or report at some point in a performing a business Use Case.

Translation Facilities

Enterprise Architect is used in almost every country in the world, and versions of the product are available in which the user interface and Help system are defined in one of several common natural languages. The model content is then written and read in the same natural language. However, now more than ever teams are engaged in distributed modeling, and collaborative development has become the norm in the business, technology, engineering and scientific communities. Much of this collaboration takes place across not only temporal and geographical boundaries, but also linguistic boundaries as the models are read, digested and augmented by groups of people who speak different natural languages.

Enterprise Architect (using a built-in Cloud integration service) provides a way for individual users to display a translation of the descriptions (notes) for various objects such as elements, operations and connectors. The mechanism uses a built-in and exemplar integration service layer to connect to remote translation services provided by Google and Microsoft. This means that a model developed in, say, Switzerland using German can be translated and viewed in Canada in English. A German modeler might define a Requirement element named '*Das System muss die ausgewählten Kanaleinstellungen anzeigen*' and a Canadian modeler could translate and view that Requirement as '*The system must display the selected channel preferences*'. Not only that, but either modeler is likely to have

French-speaking colleagues who would prefer to translate the same Requirement into French as '*Le système doit afficher les préférences de canal sélectionnées*'.

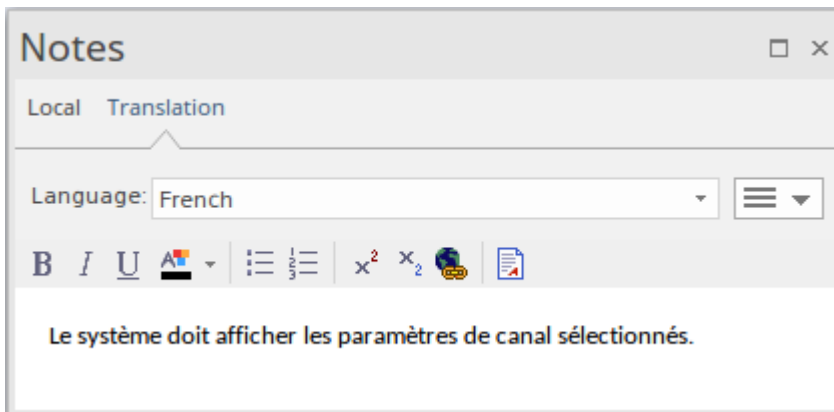
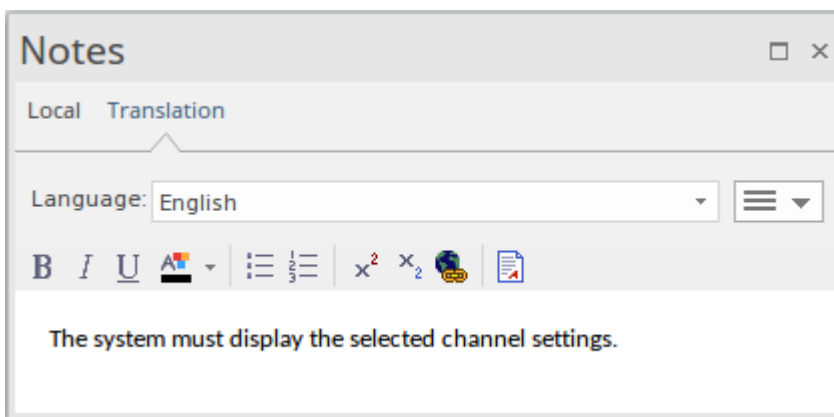
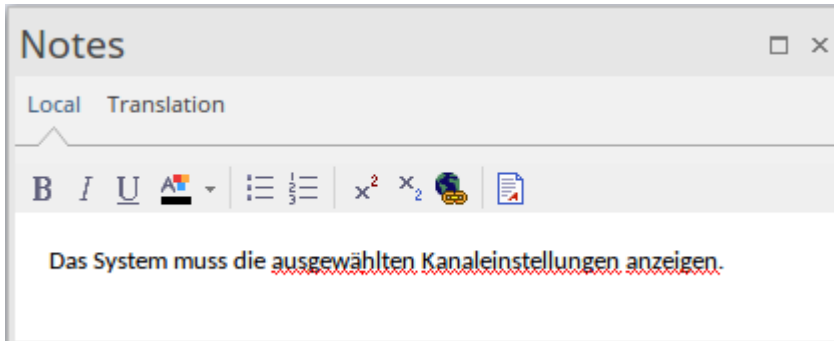

You can also record translations of element and operation names. Modeling can thus overcome not only temporal and geographic barriers, but linguistic barriers as well.

A Glossary facility also exists to override the translation of terms that are proprietary, such as product names, or in-house vernacular that should not be translated; this mechanism also provides specifically-defined translations of

terms for which the translation services would not provide the best result. A user can also manually update translated notes, and when the original text is updated the edited translation will be flagged as potentially out-of-date.

Documentation can be generated to any selected language, providing a way of producing a software and portable model narrative accessible by almost anyone in the world - perfect for cross-linguistic teams that have contractual obligations to have formal documentation in a number of languages.

In brief, the facilities of the Enterprise Architect text translation feature include:

- An Integration plug-in that enables connections to internet translation facilities via Pro Cloud Server version 4.1 and above; available in the Corporate, Unified and Ultimate Editions of Enterprise Architect, for automatic translations
- A 'Translations' page of the 'Manage Model Options' dialog, through which you configure the mode of translation, the translator application, translation options and the languages from and to which to translate the text, for the model (if User Security is enabled, you require 'Manage Reference Data' permissions to do this)
- Separate tabs in the Notes window to enter and display the Notes text in the local (or primary) language and to enter or initiate translations of that text; the 'Translation' tab enables you to select from a range of languages and to force or automatically apply translation (if using an internet translator application)
- A manual translation facility that enables you to type, in

the 'Translation' tab of the Notes window, translations of the Notes text displayed in the 'Local' tab; available in all editions of Enterprise Architect

- Notes text context menu options to flag specific instances of a term for customized translation or for protection from translation
- A tab of the Properties window for elements and operations to manually record the translated object name and alias in each of the selected languages
- Glossary model elements that you can use to either block translation of a term within a section of text, or ensure that it is translated to a specific text string
- An option in the 'Generate Document' dialog, 'Generate' tab to specify the language in which to generate the document

Configuring Automatic Translation

Automatic translation using an external translation service is configured as a Data Provider in the Integration Plug-ins facility of the Pro Cloud Server.

The procedures to configure Integration Plug-ins and to specify the Data Provider are fully documented in the Integration Plug-ins *Install and Configure* and *Add/Edit Data Provider* Help topics. However, this summary of steps puts the procedures in the context of the automatic translation service:

1. Open the Sparx Systems Pro Cloud Config Client.

2. Click on the 'Integration' tab.
3. Click on the Add button to display the Add Data Provider window.
4. Tick the 'Enabled' checkbox.
5. Give the service a name.
6. Click on the drop-down arrow in the 'Provider' field and select 'Translator'.
7. In the 'Custom Properties' panel, select a Translation Provider, such as Google or Microsoft.

Data Provider:

Enabled:

Name: * test

Provider: * Translator Prefix: * sstx

Integration Plugin

Auto Start: Port: * 8089 DLL Path: * C:\Program Files (x86)\Sparx Systems\Pro Cloud Server\SBP ...

Custom Properties

Item	Value
Google	https://translation.googleapis.com/language/translate/v2?key=%key%&sour...
Microsoft	https://api.cognitive.microsofttranslator.com/translate?api-version=3.0&text...

Logging

File Count: 3 Max File Size: 1048576 Level: WARNING

Directory: C:\Program Files (x86)\Sparx Systems\Pro Cloud Server\SBPI\Logs\

Proxy

Server Name/IP:

Bypass:

User Name: Password:

Help * Denotes a value is required OK Cancel

You will then need to restart the Pro Cloud service. We suggest you reboot the machine. Then, when you open the selected repository, automatic translation should now be available.

Note that as this is using an external translation provider it might incur a cost on the data translated and might require

setting up an account with the provider

The Properties Window Translation Tab

If you have enabled the Notes Translation facilities, and you are reviewing elements, connectors, attributes or operations, the Properties window has a 'Translation' tab containing two categories - 'Name' and 'Alias'. Each category has a field for each of the selected languages.

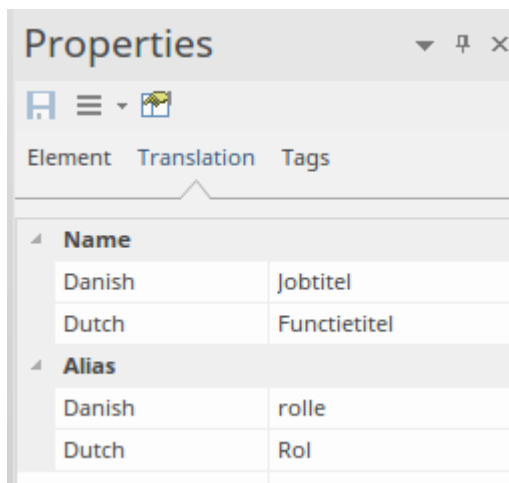





Simply click on each of these fields and type in the translation of the object's Name and/or Alias in the corresponding language. The languages are specified in the 'Manage Model Options' dialog for your model, by the model administrator.

Model Transformation

One of the great advantages of creating models is the ability to manipulate them to produce outputs, thus saving time and reducing the possibility of errors. Enterprise Architect implements Model Driven Architecture (MDA) transformations using a flexible and fully configurable template system. The templates act as instructions to a machine that takes a model as input and transforms it to a more resolved model as output. The input could be a large and complex model or a single element and one input model could be transformed to a variety of output models.

The transformations are commonly unidirectional and take a Platform Independent Model (PIM) and transform it to one or more Platform Specific Models (PSM). A good example of where this is useful is where a system must be implemented in a number of different relational database systems. A single platform independent conceptual model (the PIM) could be transformed to a number of platform specific models, say Oracle, MySQL and SQLite. As a further productivity boost, once the output models are produced they can also be converted to programming code, database definition language or schemas. Enterprise Architect automatically creates traceability that can be used to visualize how elements in the input model have been transformed to elements in the output model.

Facilities

Facility	Description
<p>Transform Elements</p> 	<p>Discover how to transform elements on a diagram or from a Browser window Package.</p>
<p>Built-in Transformations</p> 	<p>Enterprise Architect provides a number of built-in transformations that support a wide range of target languages. Each is fully customizable to your specific needs.</p>
<p>Edit Transformation Templates</p> 	<p>Learn how to adjust the transformation templates to produce transformations specific to your system.</p>
<p>Write Transformations</p> 	<p>All the information you will need to create your own transformations.</p>

Ready-built Transformations

The Enterprise Architect installer includes a number of basic

built-in transformations, including:

- PIM to:
 - C#
 - C++
 - DDL table elements
 - EJB Entity Bean
 - EJB Session Bean
 - Java
 - PHP
 - VB.Net
 - XSD
- Data Model to Entity Relationship diagram (ERD)
- Entity Relationship diagram (ERD) to Data Model
- Sequence diagram to Communication diagram
- Communication diagram to Sequence diagram
- Java model to JUnit test model
- .NET model to NUnit test model
- WSDL interface model to WSDL

Further transformations will become available over time, either built in or as downloadable modules from the Sparx Systems website.

Customized Transformations

You can modify the built-in transformations or define your own, using Enterprise Architect's simple code generation template language. This involves little more than writing

templates to create a simple intermediary source file; the system reads the source file and binds that to the new PSM.

Transformation Dependencies

When you execute a transformation, the system creates internal bindings (Transformation Dependencies) between each PSM created and the original PIM. This is essential, providing the ability to forward synchronize from the PIM to the PSM many times, adding or deleting features as you go; for example, adding a new attribute to a PIM Class can be forward synchronized to a new column in the Data Model.

You can observe the Transformation Dependencies for a Package using the Traceability window, to check the impact of changes to a PIM element on the corresponding elements in each generated PSM, or to verify where a change required in a PSM should be initiated in the PIM (and also to reflect back in other PSMs). The Transformation Dependencies are a valuable tool in managing the traceability of your models.

Enterprise Architect does not delete or overwrite any element features that were not originally generated by the transform; therefore, you can add new methods to your elements, and Enterprise Architect does not act on them during the forward generation process.

Example of a Transformation

This diagram highlights how transformations work and how

they can significantly boost your productivity.

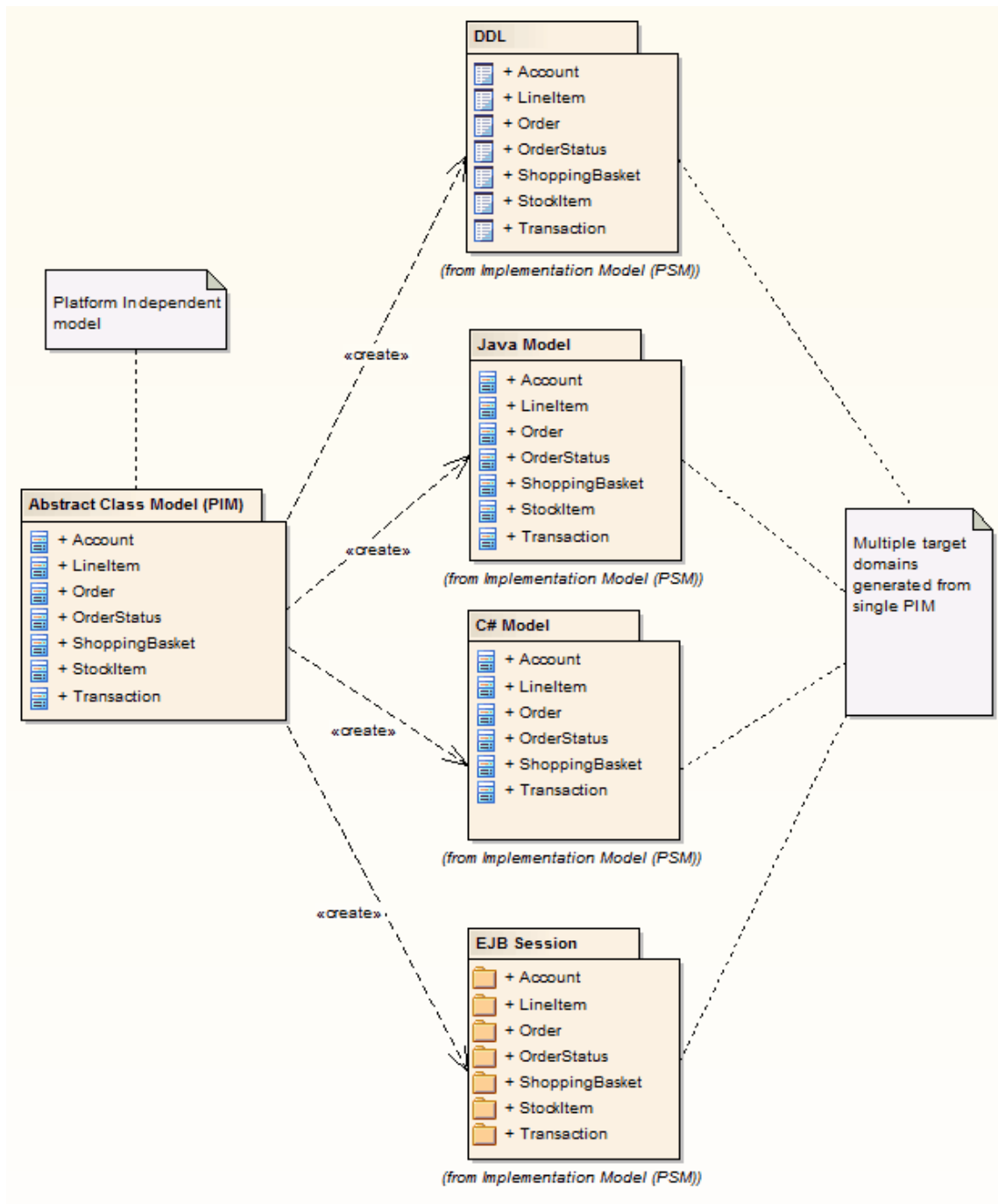

Notes

- If you are using the Corporate, Unified or Ultimate Edition, if security is enabled you must have 'Transform Package' access permission to perform an MDA

Transformation on the elements of a Package

Transform Elements

A model transformation is a user initiated function that starts the process of transforming one or more Platform Independent Model (PIM) elements into their corresponding Platform Specific Model (PSM) elements. This process takes place in accordance with the rules that have been codified in the Transformation Templates. The transformation can be initiated by selecting a Package in the Browser window or an element in a diagram.

Access

Ribbon	Design > Package > Transform > Transform Selection
Keyboard Shortcuts	Ctrl+H (transform selected elements) Ctrl+Shift+H (transform selected Package)

Perform a Transformation

Option	Action
Elements	Lists all of the individual elements

	<p>selected in the diagram or held in the Package. Either:</p> <ul style="list-style-type: none"> • Click on an element to include just that element in the transformation • Hold Ctrl and click on several separate elements to include them in the transformation, or • Hold Shift and click on the first and last elements in a block to include those elements in the transformation
<p>All</p>	<p>Click on this button to select all of the elements in the list to include them in the transformation.</p>
<p>None</p>	<p>Click on this button to deselect all of the elements in the list.</p>
<p>Include child packages</p>	<p>(If you have selected to transform elements in a Package.)</p> <p>Select this checkbox to include (in the 'Elements' list and potentially in the transformation) elements from the child Packages of the selected Package.</p>
<p>Transformations</p>	<p>Select the checkbox against each type of transformation to perform. When you select a checkbox, the 'Browse Project' dialog displays; locate and select the</p>

	<p>target Package into which to generate the transformed elements.</p> <p>If you want to change a selected target Package, click on the <input type="button" value="..."/> button to the right of the Package name and select the new Package from the dialog.</p>
Generate Code on result	<p>Select this checkbox to specify whether or not to automatically generate code for transformed Classes that target code languages.</p> <p>If you select this option, the first time you transform to the Class the system prompts you to select a filename to generate code into; subsequent transformations automatically generate code to that filename.</p>
Perform Transformations on result	<p>Select the checkbox to automatically execute transformations previously done on the target Class or Classes.</p>
Intermediary File	<p>If you want to capture the intermediary language file (for example, to debug it), either type in the file path and name or click on the <input type="button" value="..."/> button and locate and select the file.</p>
Write	<p>Select this checkbox to always write the</p>

Always	intermediary file to disk.
Write Now	Click on this button to generate the intermediary file without performing the full transformation.
Do Transform	Click on this button to execute the transformation. When the transformation is complete, the 'Model Transformation' dialog closes.
Close	Click on this button to close the 'Model Transformation' dialog without performing the transformation.

Notes

- When the dialog displays, all elements are selected and all transformations previously performed from any of these Classes are checked
- This procedure does not apply to the Sequence diagram/Communication diagram transformation, or the Communication diagram/Sequence diagram transformation

Chaining Transformations

Chaining transformations provides an extra degree of flexibility and power to performing transformations. For example, if two transformations have a common element; you might separate this element out into its own transformation, and then perform the original transformations from the common point. The separated transform could even produce a useful model itself.

You can chain transformations by selecting the 'Perform Transformations on result' checkbox in the 'Model Transformation' dialog, so that transformations that have already been performed on target Classes are executed automatically next time that Class is transformed to.

Built-in Transformations

Enterprise Architect provides a rich set of built-in, commonly performed transformations. These will prove useful to a variety of disciplines from Domain Modeling to Code Engineering. The facility to transform models is a practical productivity tool and it is expected that modelers will want to create their own custom transformations. The built-in transformations provide useful examples and are a valuable reference for the modeler.

Built-in Transformations

Transformation	Converts
C#	Platform-Independent Model (PIM) elements to language-specific C# Class elements.
C++	PIM elements to language-specific C++ Class elements.
Data Definition Language	A logical model to a data model targeted at the default database type, ready for DDL generation.
Entity	An ERD logical model to a data model

Relationship Diagram to Data Model	targeted at the default database type, ready for DDL generation.
Data Model to Entity Relationship Diagram	A data model to an ERD logical model.
EJB Session Bean	A single Class element to the elements of an EJB session.
EJB Entity Bean	A single Class element to the elements of an EJB entity.
Java	PIM elements to language-specific Java Class elements.
JUnit	An existing Java Class element with public methods to a Class with a test method for each public method, plus the methods required to appropriately set up the tests.
NUnit	An existing .NET compatible Class with public methods to a Class with a test method for each public method, plus the methods required to appropriately set up the tests.

PHP	PIM elements to language-specific PHP Class elements.
Sequence/Communication Diagram	All elements and messages in an opened Sequence diagram into matching elements and messages in a Communication diagram, and vice versa.
VB.Net	PIM elements to language-specific VB.Net Class elements.
WSDL	A simple model to an expanded model of a WSDL interface, suitable for generation.
XSD	PIM elements to UML Profile for XML elements, as an intermediary step in creating an XML Schema.

C# Transformation

The C# transformation converts Platform-Independent Model (PIM) element types to C#-specific Class element types, and creates encapsulation according to the system options you have set for creating properties from C# attributes (on the 'C# Specifications' page of the 'Preferences' dialog).

Example

The PIM elements

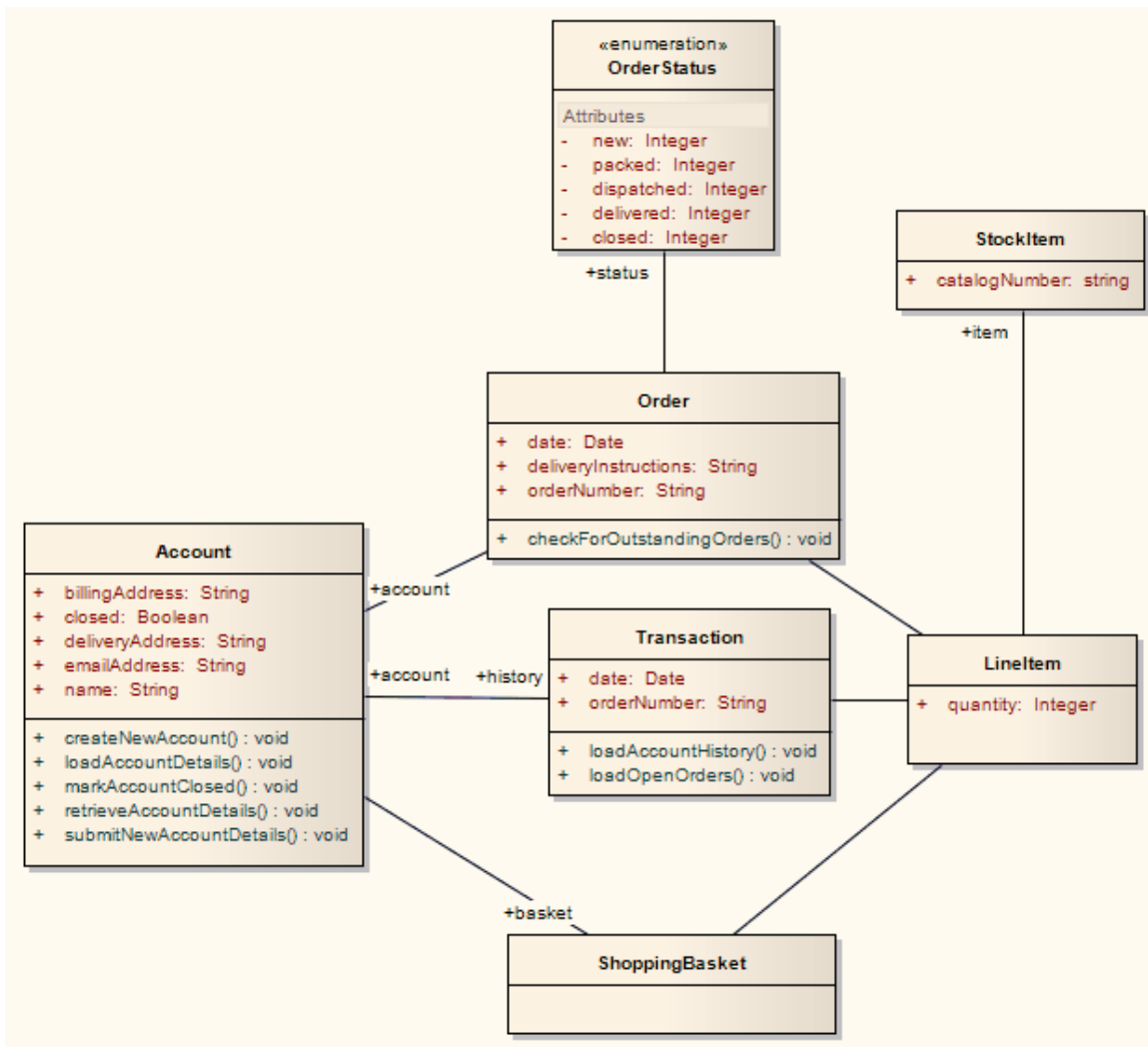

After transformation, become the PSM elements

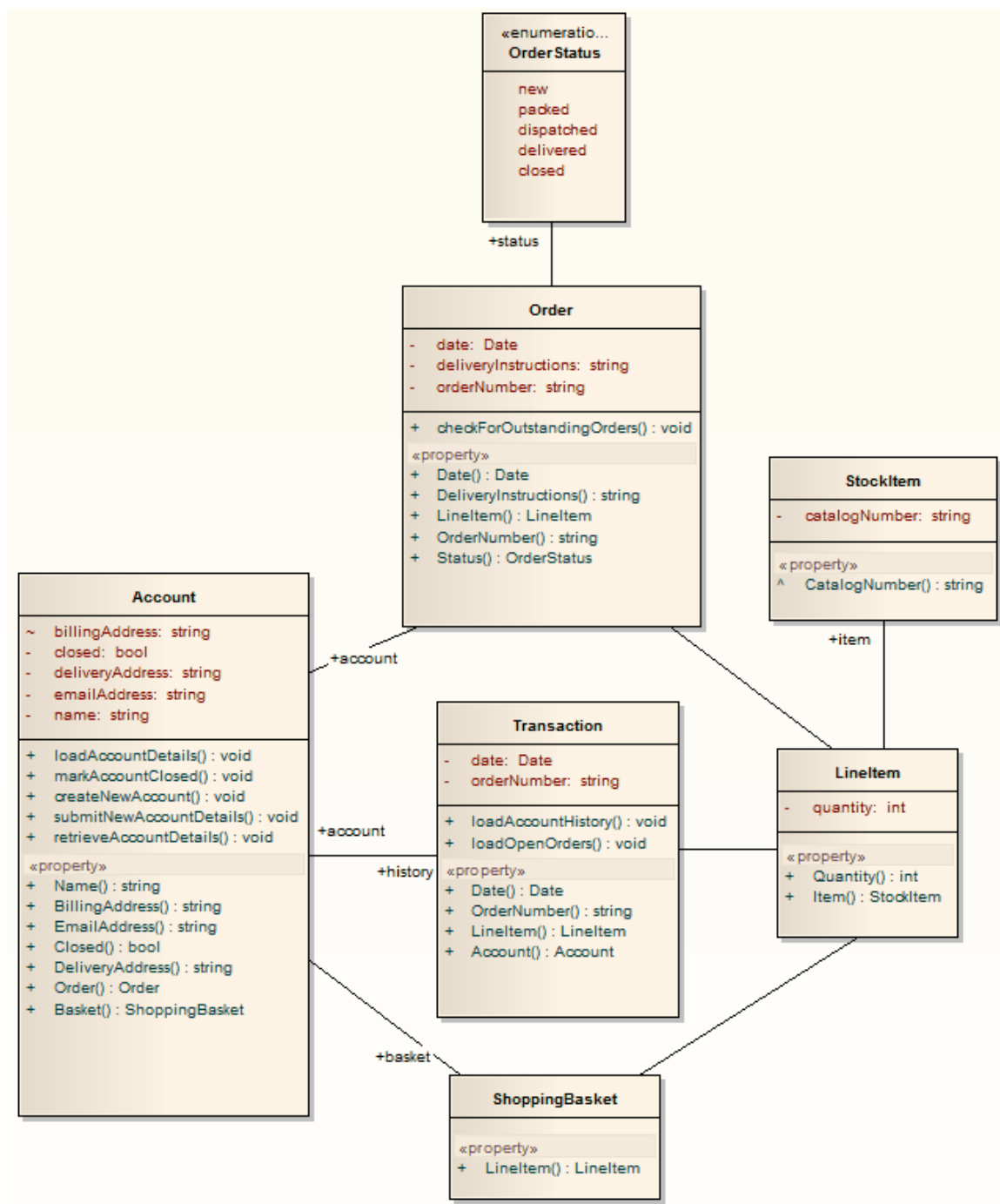

C++ Transformation

The C++ transformation converts Platform-Independent Model (PIM) element types to C++ specific Class element types and creates encapsulation (producing the getters and setters) according to the options you have set for creating properties from C++ attributes (on the 'C++ Specifications' page of the 'Preferences' dialog). Note that the public attributes in the PIM are converted to private attributes in the PSM. All operations on an interface are transformed into pure virtual methods on an equivalent class.

Example

The PIM elements

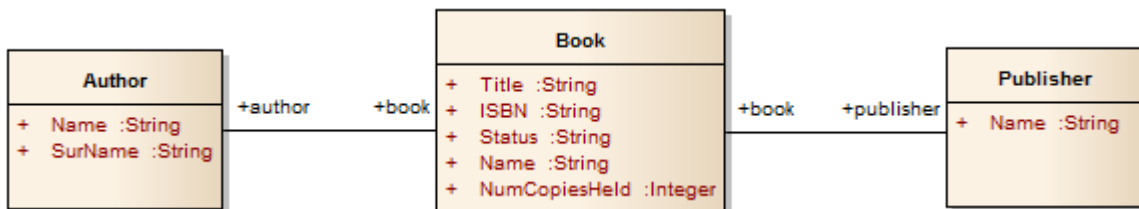

After transformation, become the PSM elements

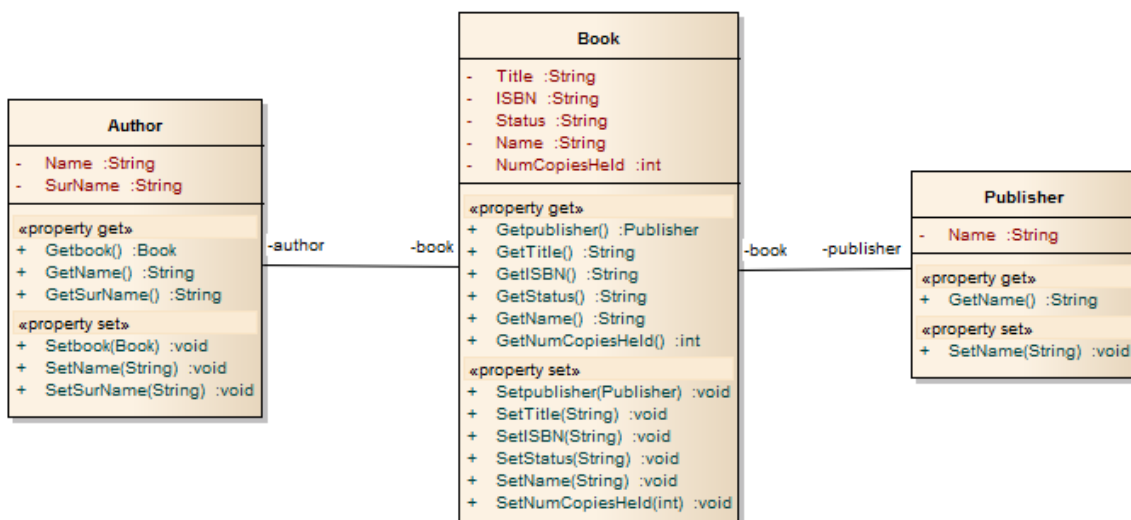

Data Model To ERD Transformation

The Data Model to Entity Relationship diagram (ERD) transformation creates an ERD logical model from a Data Model. It is the reverse of the ERD to Data Model transformation. This transformation uses and demonstrates support in the intermediary language for a number of database-specific concepts.

Supported Concepts

Concept	Effect
Entity	Mapped one-to-one onto Table elements.
Attribute	Mapped one-to-one onto Columns.
Primary Key	Derived from the PrimaryKey type of column.

Notes

- Sometimes you might want to limit the stretch of the diamond-shaped Relationship connectors; simply pick a Relationship connector, right-click to display the context menu, and select the 'Bend Line at Cursor' option

DDL Transformation

The DDL transformation converts the logical model to a data model structured to conform to one of the supported DBMSs. The target database type is determined by which DBMS is set as the default database in the model (see the *Database Datatypes* Help topic, 'Set As Default' option). The data model can then be used to automatically generate DDL statements to run in one of the system-supported database products.

The DDL transformation uses and demonstrates support in the intermediary language for a number of database-specific concepts.

Concepts

Concept	Effect
Table	Mapped one-to-one onto Class elements. 'Many-to-many' relationships are supported by the transformation, creating Join tables.
Column	Mapped one-to-one onto attributes.
Primary Key	Lists all the columns involved so that they exist in the Class, and creates a Primary Key Method for them.

Foreign Key	<p>A special sort of connector, in which the Source and Target sections list all of the columns involved so that:</p> <ul style="list-style-type: none">• The columns exist• A matching Primary Key exists in the destination Class, and• The transformation creates the appropriate Foreign Key
-------------	--

MDG Technology to customize default mappings

DDL transformations that target a new, user defined DBMS require an MDG Technology to map the PIM data types to the new target DBMS.

To do this, create an MDG Technology .xml file named 'UserDBMS Types.xml', replacing UserDBMS with the name of the added DBMS. Place the file in the EA\MDGTechnologies folder. The contents of the MDG Technology file should have this structure:

```
<MDG.Technology version="1.0">  
  <Documentation id="UserdataTypes" name="Userdata  
Types" version="1.0" notes="DB Type mapping for  
UserDBMS"/>
```

```
<CodeModules>
  <CodeModule language="Userdata" notes="">
    <CodeOptions>
      <CodeOption
name="DBTypeMapping-bigint">BIGINT</CodeOption>
      <CodeOption
name="DBTypeMapping-blob">BLOB</CodeOption>

      <CodeOption
name="DBTypeMapping-boolean">TINYINT</CodeOption>
      <CodeOption
name="DBTypeMapping-text">CLOB</CodeOption>
      ...
    </CodeOptions>
  </CodeModule>
</CodeModules>
</MDG.Technology>
```

As an example, 'text' is a Common Type (as listed in the 'Database Datatypes' dialog) that maps to a new DBMS's 'CLOB' data type.

Notes

- You can define DBMS-specific aspects not depicted in a Logical model, such as Stored Procedures, Triggers,

Views and Check Constraints, after the transformation;
see the *Physical Data Model* Help topic

Example

The PIM elements

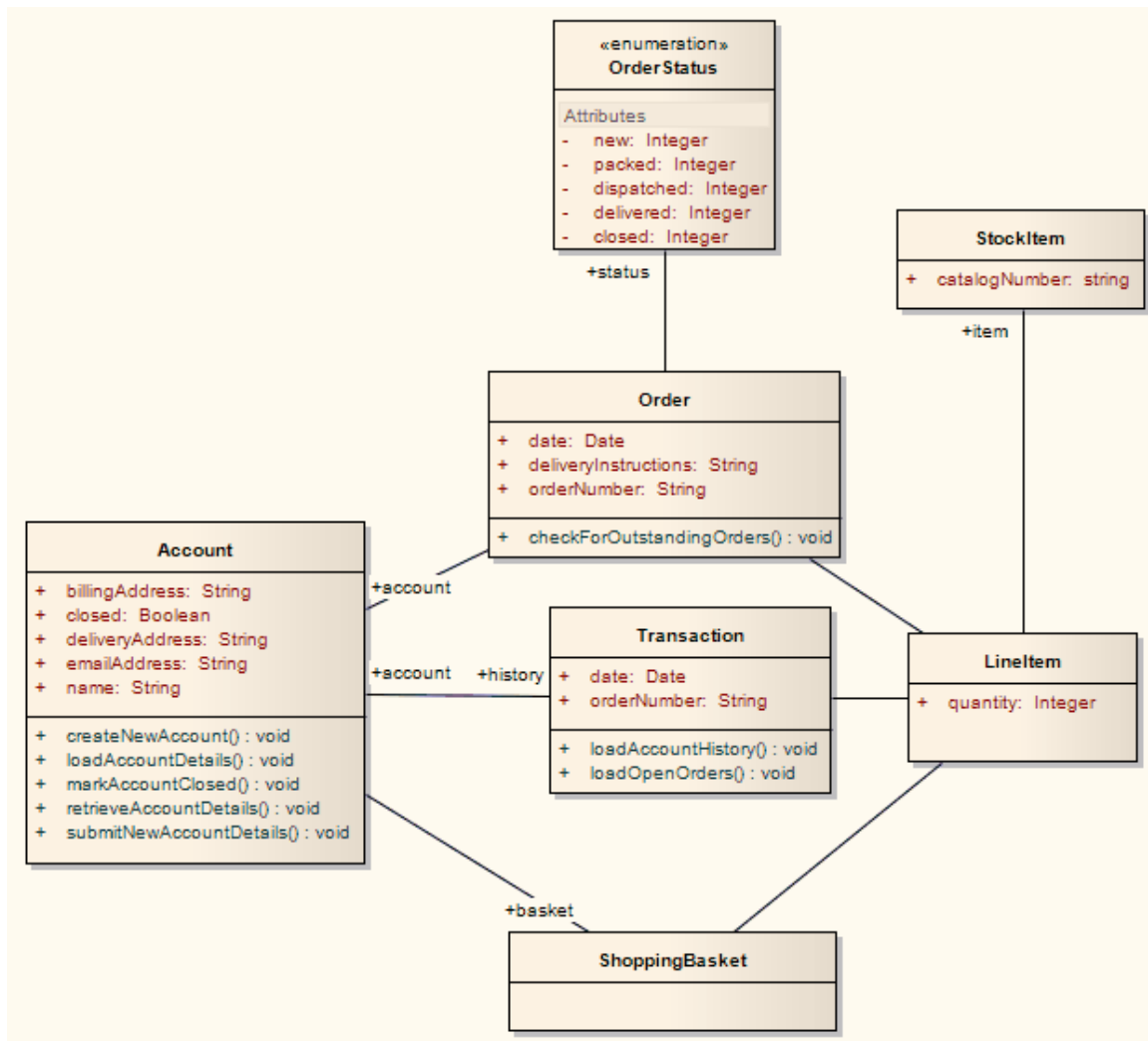

After transformation, become the PSM elements

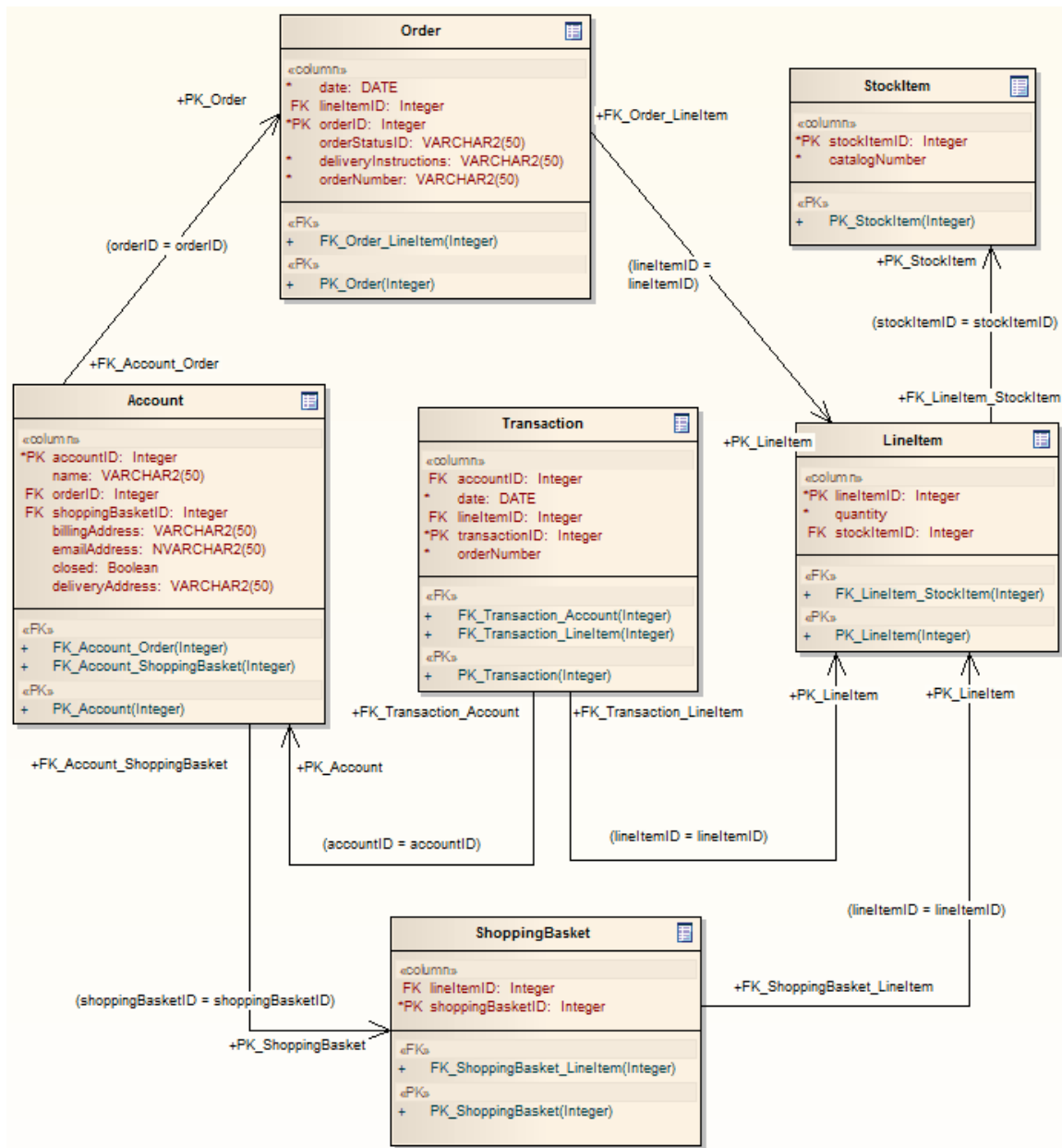

Generalizations are handled by providing the child element with a Foreign Key to the parent element, as shown. Copy-down inheritance is not supported.

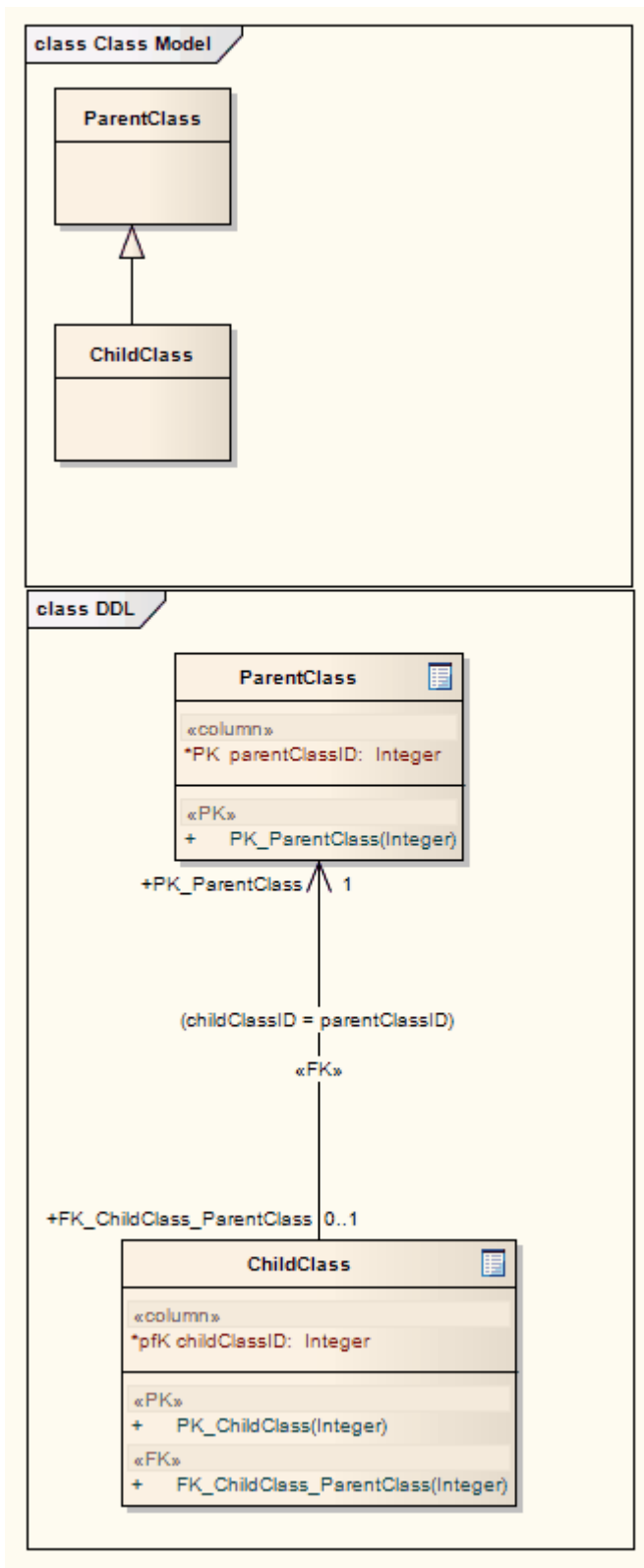

EJB Transformations

The EJB Session Bean and EJB Entity Bean transformations reduce the work required to generate the internals of Enterprise Java Beans. You can therefore focus on modeling at a higher level of abstraction.

Transformations

Both transformations also generate a META-INF Package containing a deployment descriptor element.

Transformation	Detail
EJB Session Bean	<p>This transformation converts a single Class element (containing the attributes, operations and references required for code generation by the javax.ejb.* Package) to</p> <ul style="list-style-type: none"> • An implementation Class element • A home interface element • A remote interface element
EJB Entity Bean	<p>This transformation converts a single Class element (containing the attributes, operations and references required for code generation by the javax.ejb.* Package) to:</p>

- An implementation Class element
- A home interface element
- A remote interface element
- A Primary Key element

Example

The PIM elements

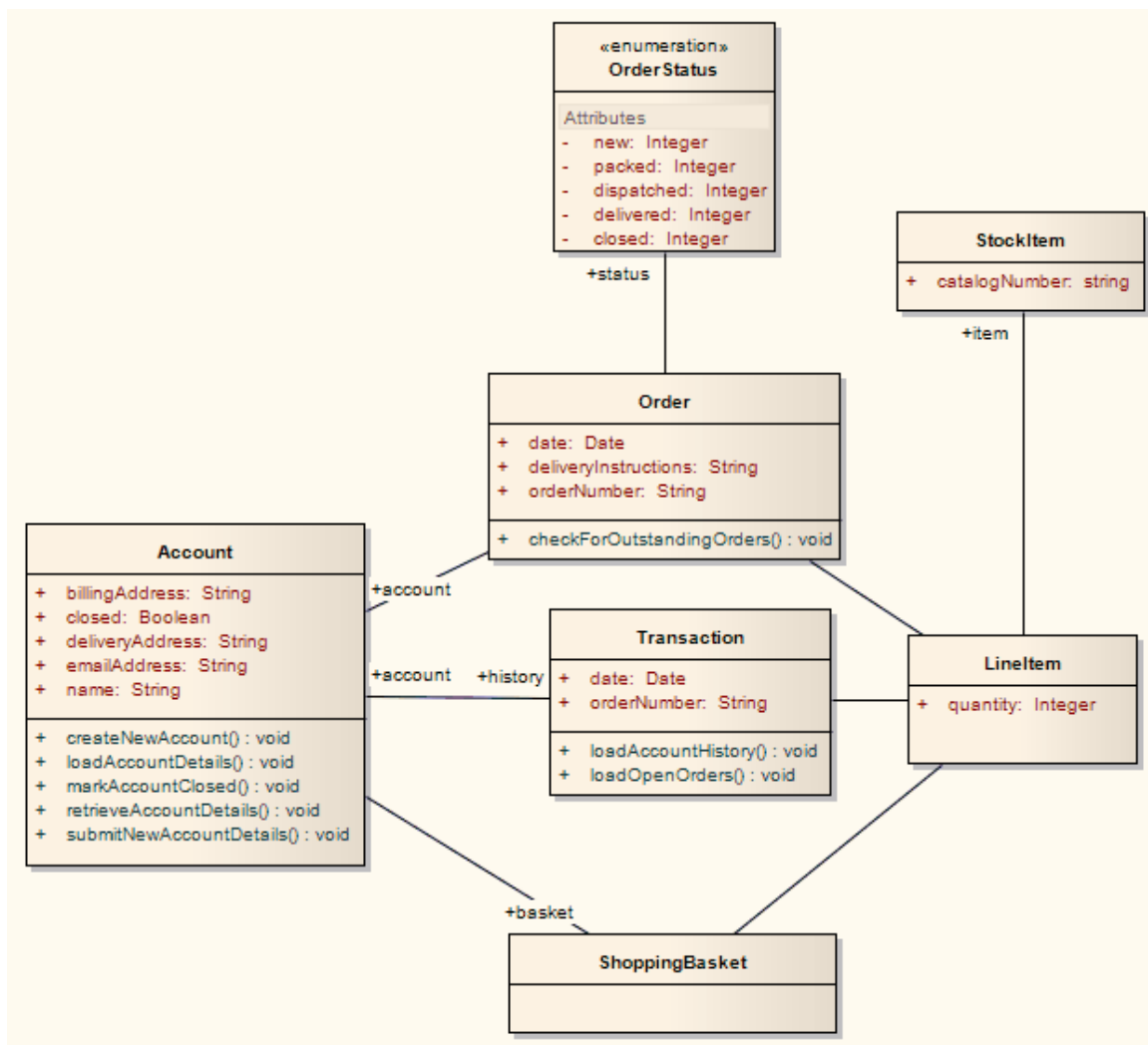

After transformation generate a set of Entity Beans, where each one takes this form (for the Account Class):

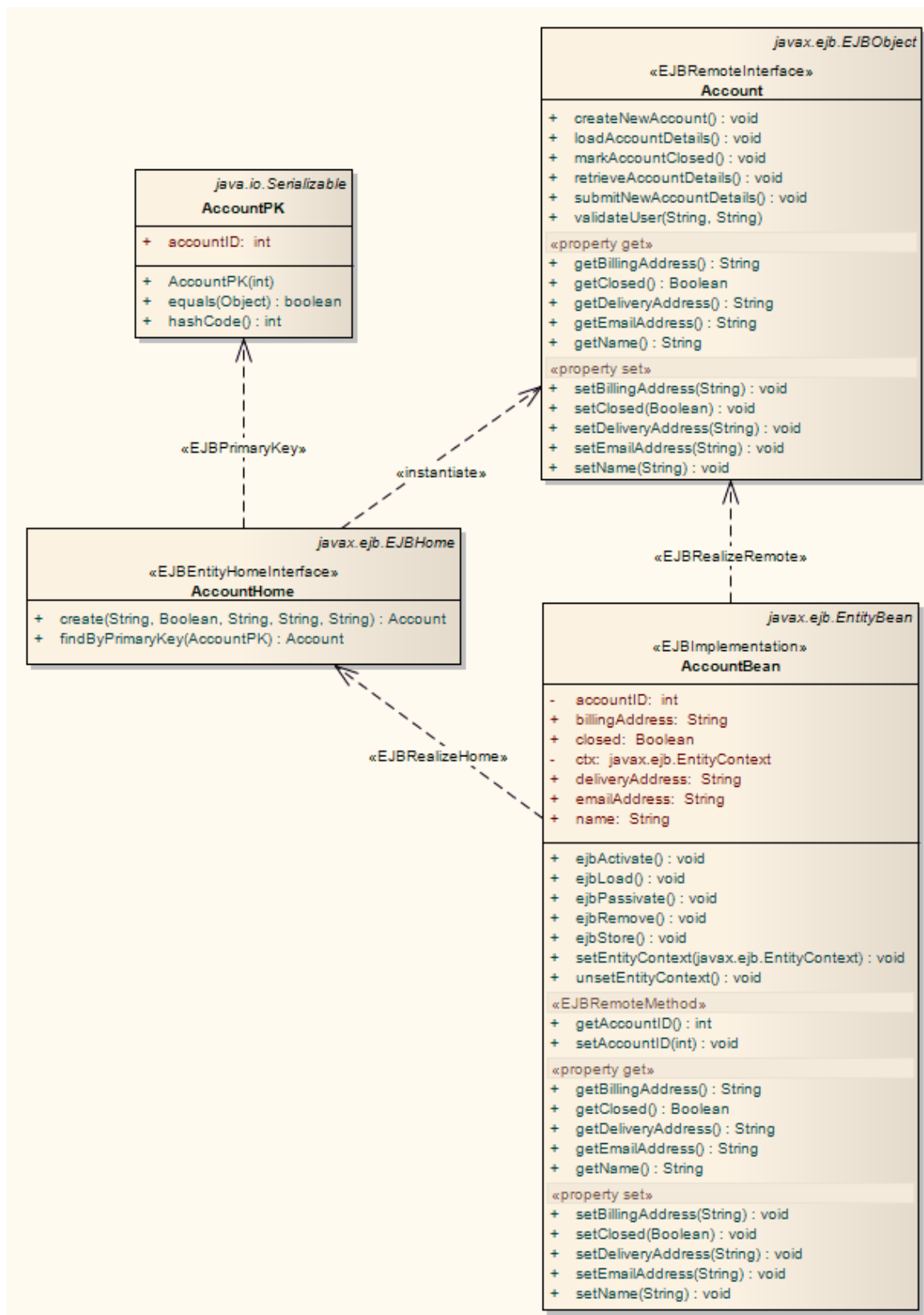

ERD To Data Model Transformation

The Entity Relationship Diagram (ERD) to Data Model transformation converts an ERD logical model to a data model targeted at the default database type, ready for generating DDL statements to run in one of the system-supported database products. Before doing the transformation, you define the common data type for each attribute and select a database type as the default database. You can then automatically generate the Data Modeling diagram.

The transformation uses and demonstrates support in the intermediary language for a number of database-specific concepts.

Concepts

Concept	Definition
Table	Mapped one-to-one onto Class elements.
Column	Mapped one-to-one onto attributes.
Primary Key	Lists all the columns involved so that they exist in the Class, and creates a Primary Key Method for them.
Foreign Key	A special sort of connector, in which the

	<p>Source and Target sections list all of the columns involved so that:</p> <ul style="list-style-type: none">• The columns exist• A matching Primary Key exists in the destination Class, and• The transformation creates the appropriate Foreign Key
--	--

Generalization

ERD technology can handle Generalization, as shown. Note that the copy-down inheritance is currently supported with two levels only.

Example

The ERD elements

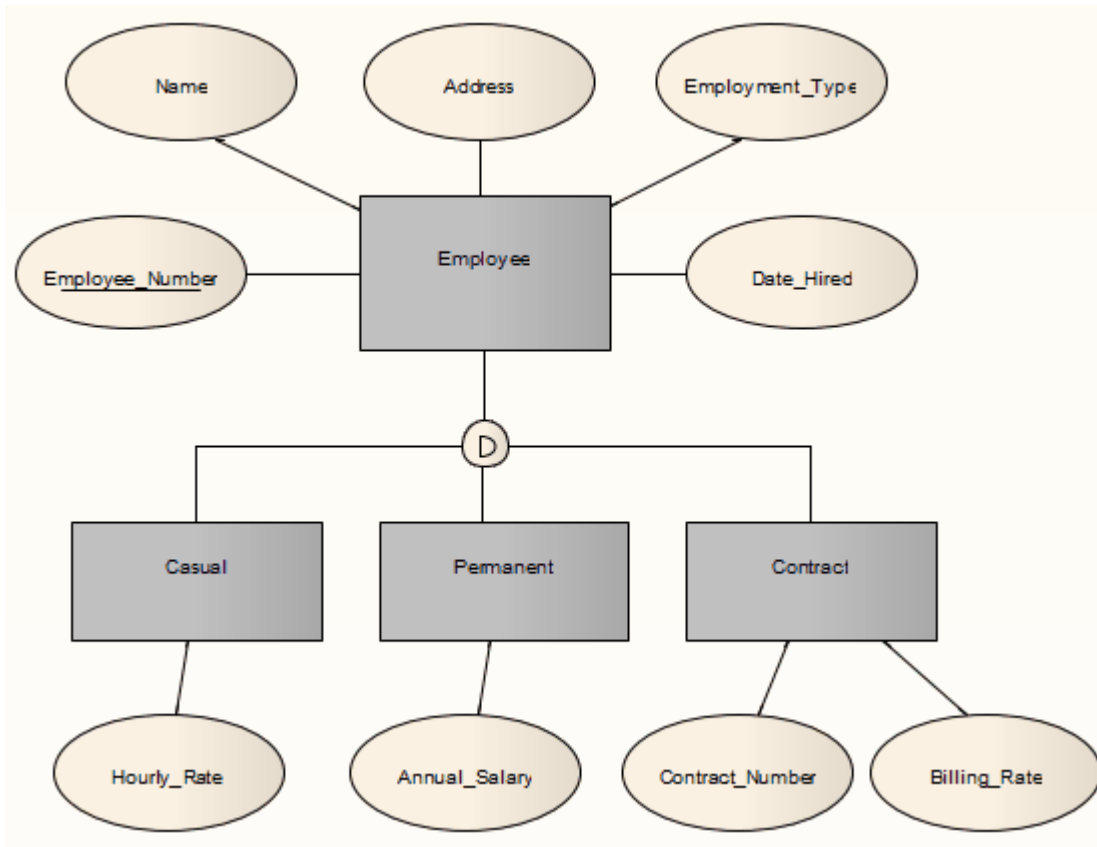

After transformation, become the Data Model elements

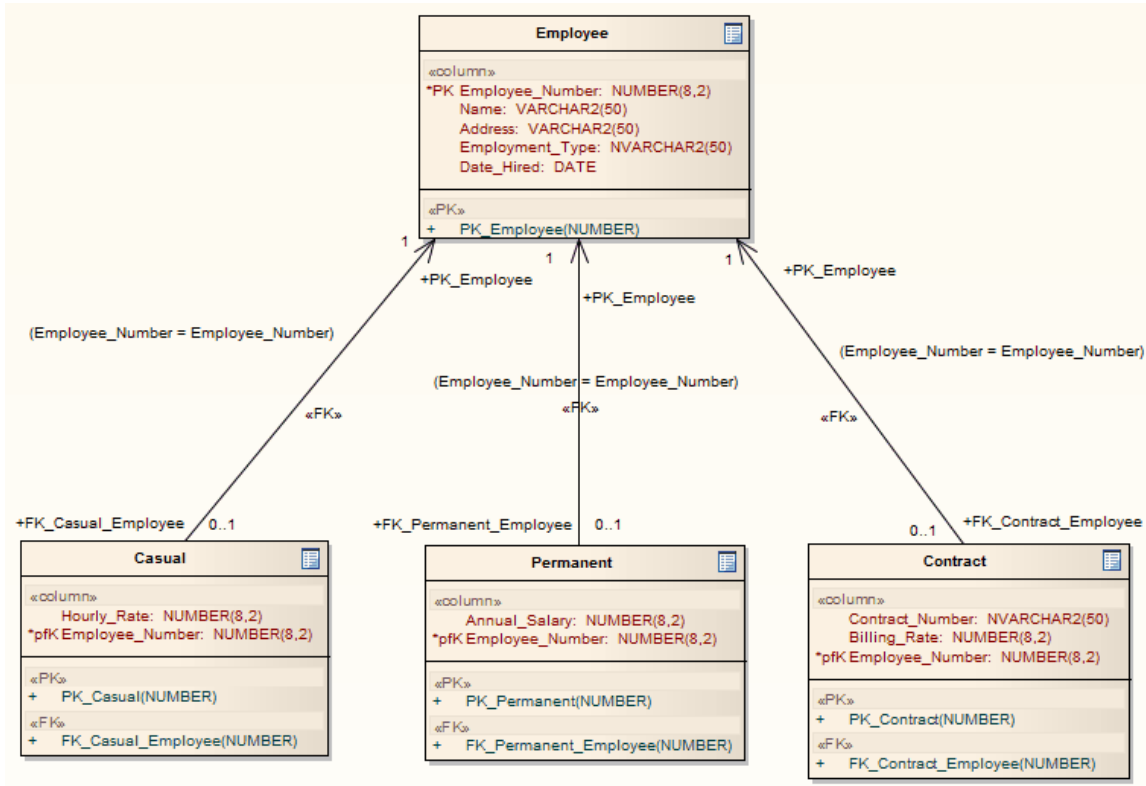

Notes

- Sometimes you might go back to the ERD, make some changes and then need to do another transformation; in this case, to achieve better results, always delete the previous transformation Package before doing the next transformation

Java Transformation

The Java transformation converts Platform-Independent Model (PIM) element types to Java-specific Class element types, and creates encapsulation (producing the getters and setters) according to the options you have set for creating properties from Java attributes (on the 'Java Specifications' page of the 'Preferences' dialog). Note that the public attributes in the PIM are converted to private attributes in the PSM. All operations in the interface are transformed into pure virtual methods.

Example

The PIM elements

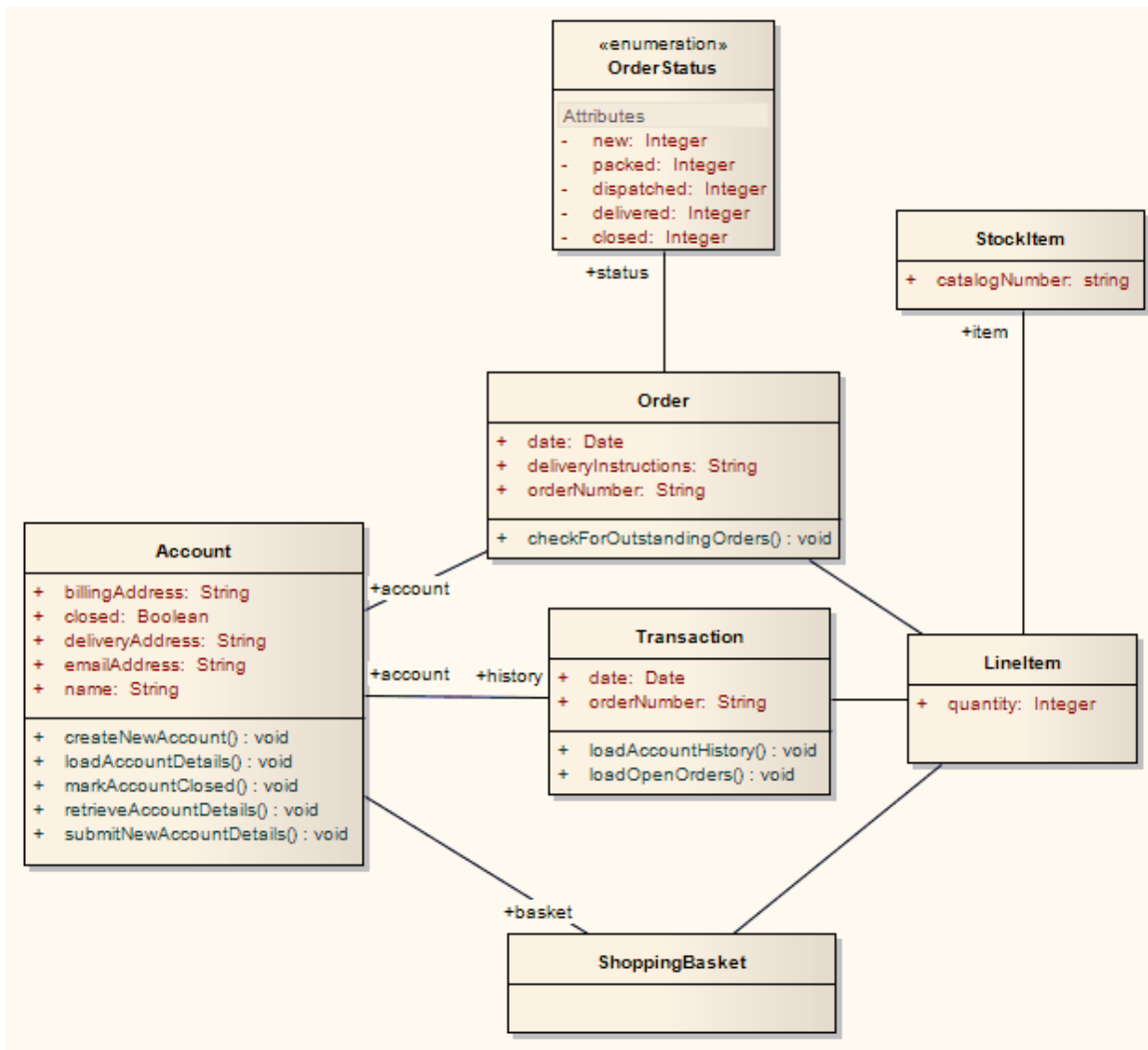

After transformation, become the PSM elements

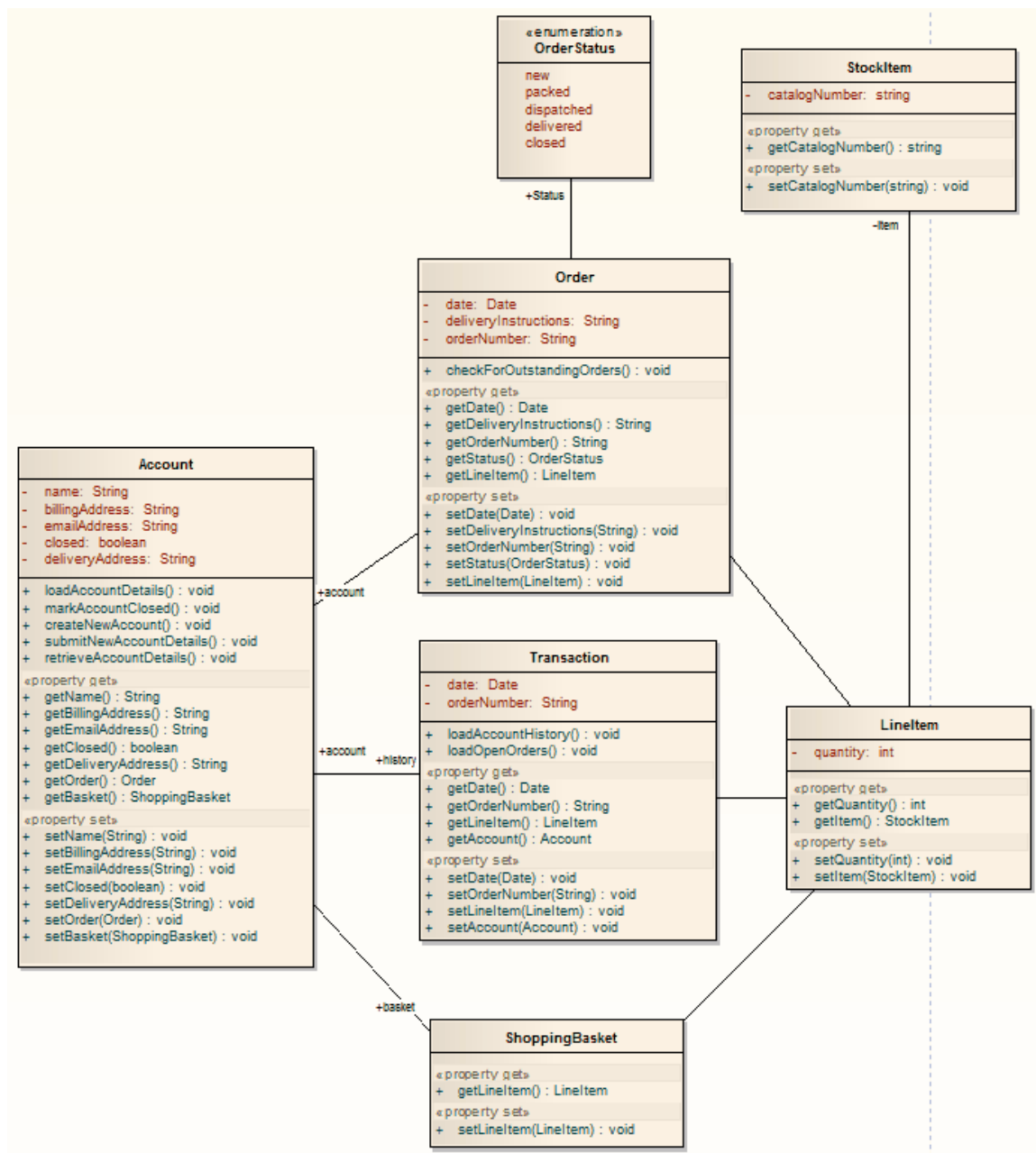

JUnit Transformation

The JUnit transformation converts an existing Java Class with public methods into a Class with a test method for each public method. The resulting Class can then be generated and the tests filled out and run by JUnit.

Example

The Java model elements (originally transformed from the PIM)

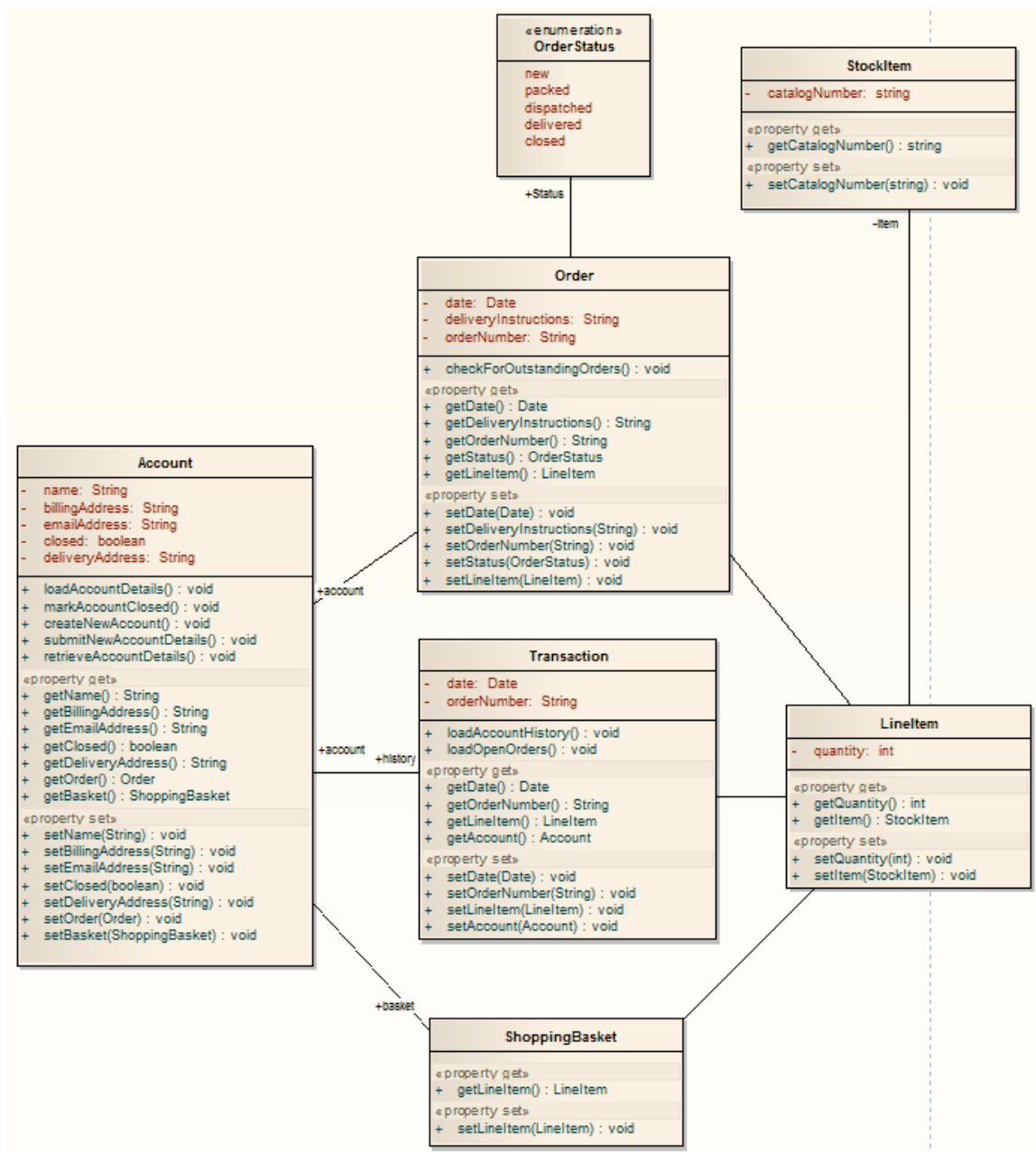

After transformation, become the PSM elements

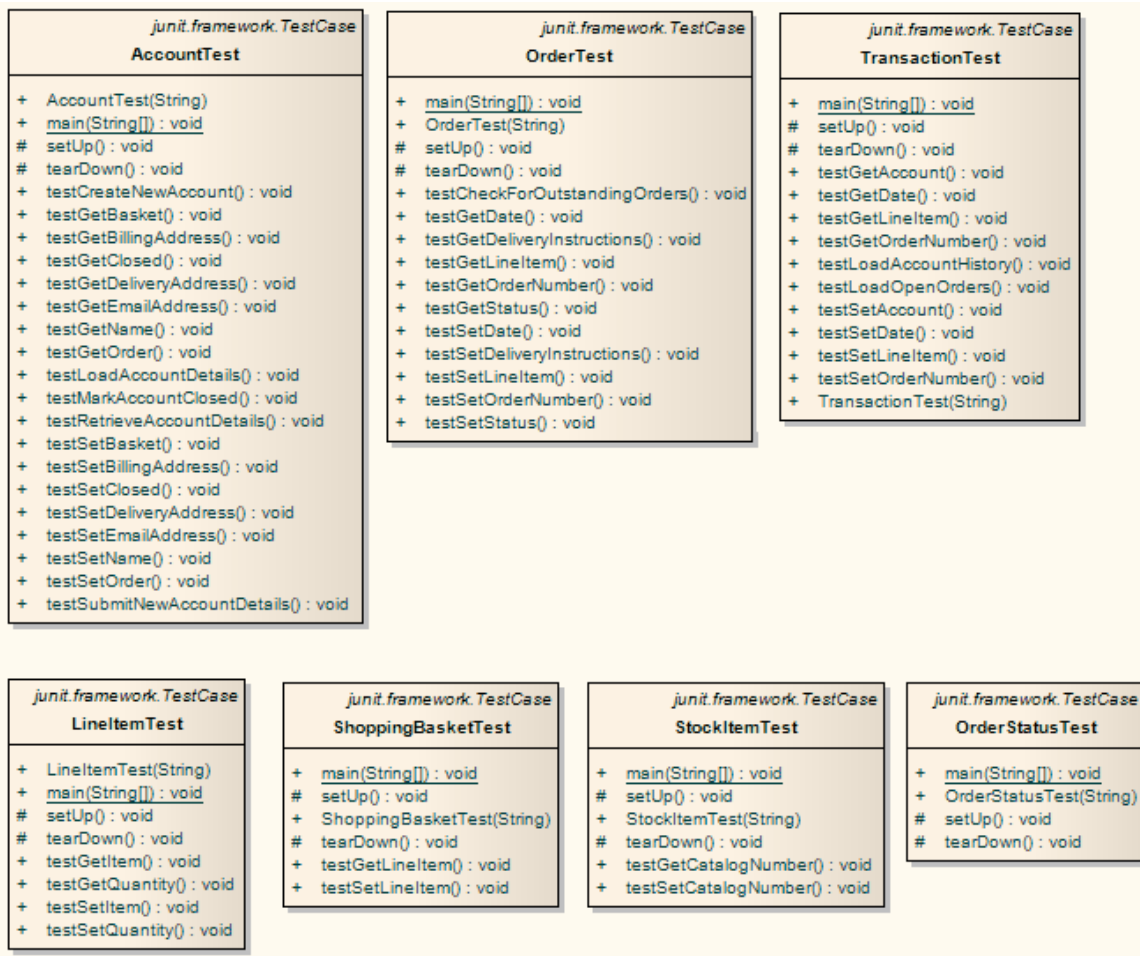

Notes

- For each Class in the Java model, a corresponding Test Class has been created containing a test method for every public method in the source Class, plus the methods required to appropriately set up the tests; you fill in the details of each test

NUnit Transformation

The NUnit transformation converts an existing .NET compatible Class with public methods into a Class with a test method for each public method. The resulting Class can then be generated and the tests filled out and run by NUnit.

Example

The C# elements (originally transformed from the PIM)

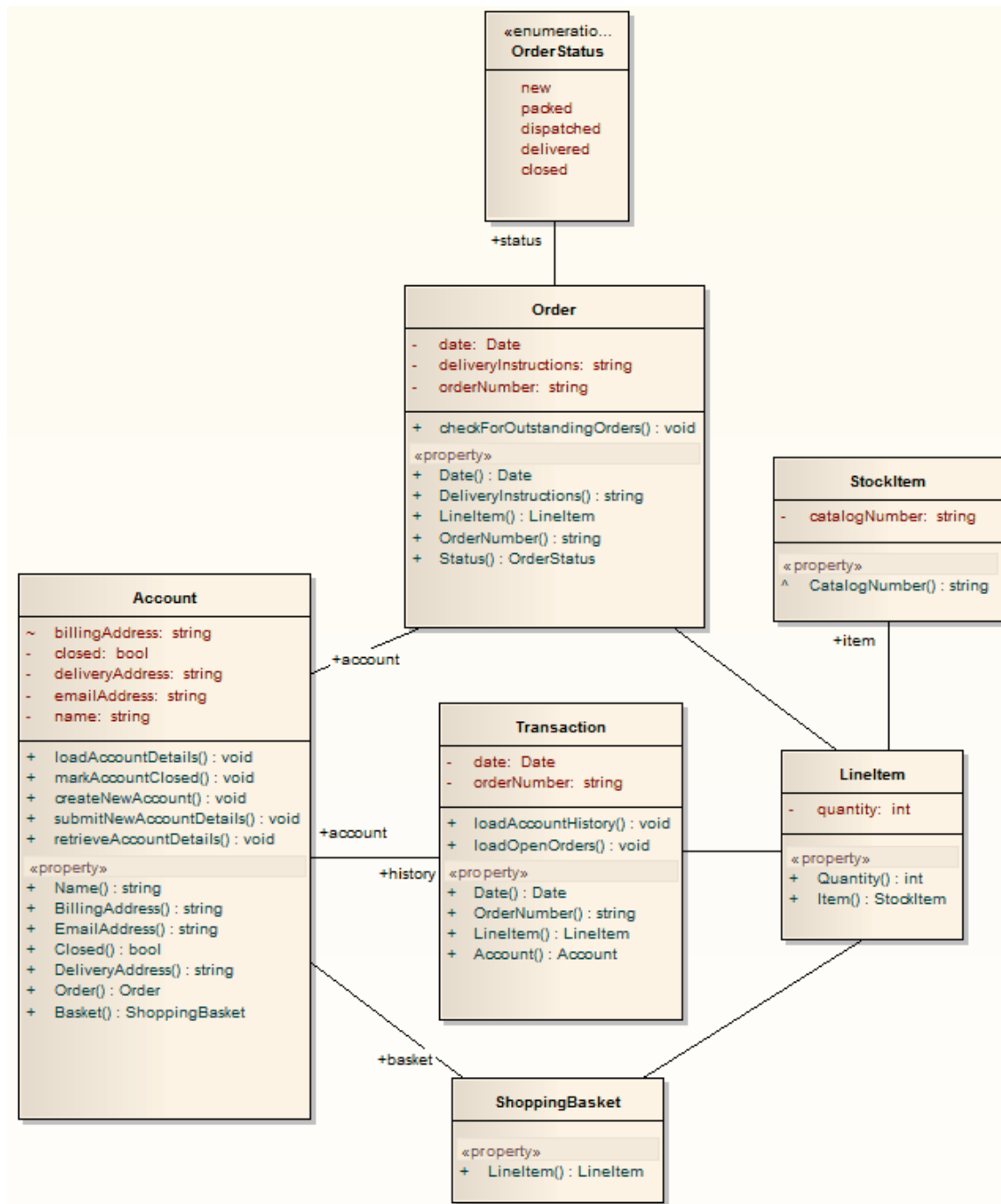

After transformation, become the PSM elements

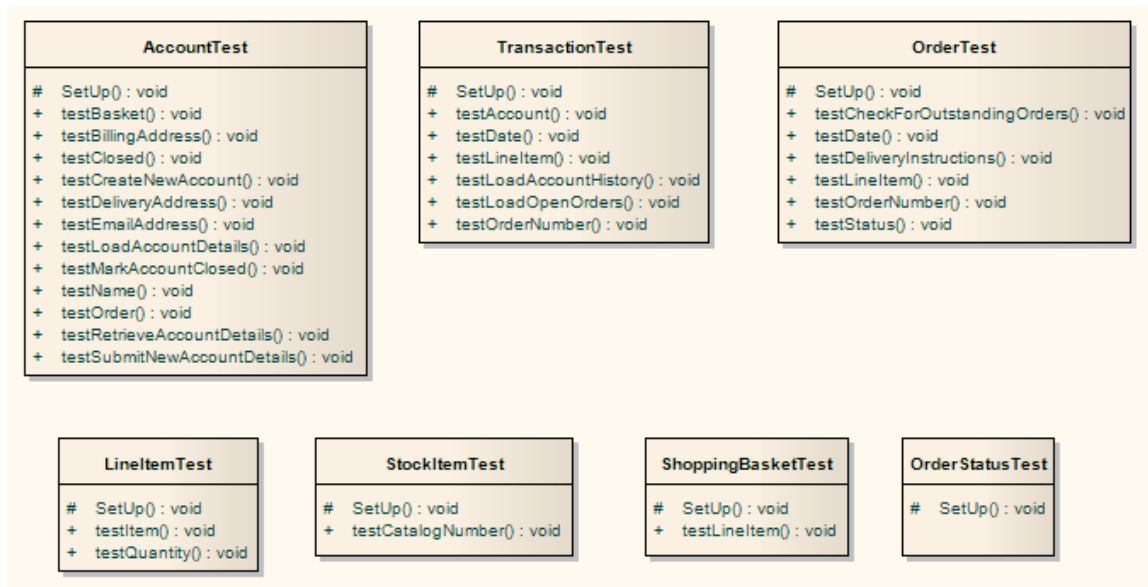

Notes

- For each Class in the C# model, a corresponding Test Class has been created containing a test method for every public method in the source Class, plus the methods required to appropriately set up the tests; you fill in the details of each test

PHP Transformation

The PHP transformation converts Platform-Independent Model (PIM) element types to language-specific PHP Class element types and creates encapsulation (producing the getters and setters) according to the options you have set for creating properties from PHP attributes (on the 'PHP Specifications' page of the 'Preferences' dialog). Note that the public attributes in the PIM are converted to private attributes in the PSM.

Example

The PIM elements

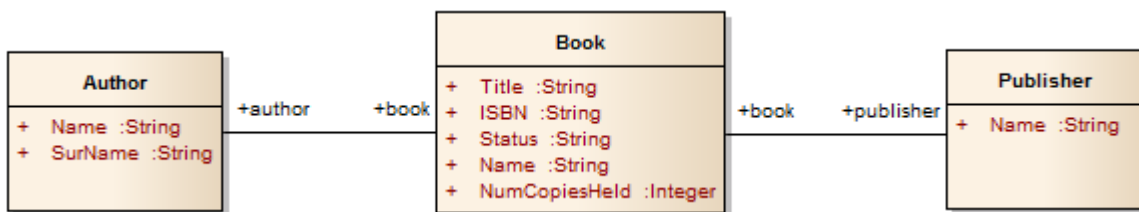

After transformation, become the PSM elements

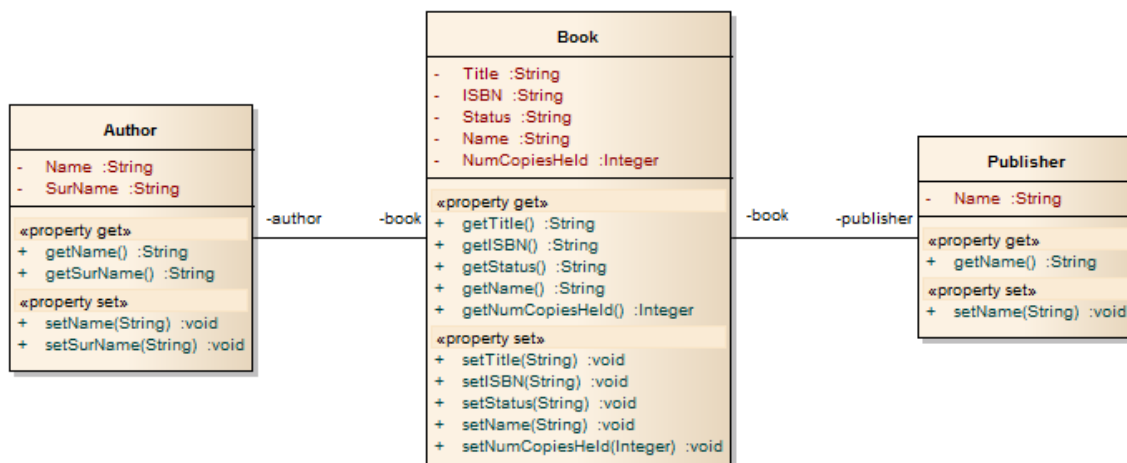

Sequence/Communication Diagram Transformations

Sequence diagrams can be transformed into a Communication diagram, and Communication diagrams into a Sequence diagrams. In each case, every element or message in the source diagram type is mapped 1:1 to a matching element or message in the target diagram.

Access

Ribbon	Design > Package > Transform > Transform Selection
Keyboard Shortcuts	Ctrl+Shift+H (transform current Package) Ctrl+H (transform selected elements)

Perform a Transformation

The diagram being transformed must be open in the main diagram view for the 'Communication' or 'Sequence' options to appear in the Model Transformation dialog.

Step	Action

1.	Open and select in the diagram view, the diagram to be transformed.
2.	Open the <i>Model Transform</i> dialog using: Design > Package > Transform > Transform Selection (Ctrl+Shift+H).
3.	In the <i>Elements</i> list, highlight all the elements from the diagram, which will be included in the transformation.
4.	In the <i>Transformations</i> list, select: <ul style="list-style-type: none">• The 'Communication' checkbox, if transforming a Sequence diagram into a Communication diagram, or• The 'Sequence' checkbox, if transforming a Communication diagram into a Sequence diagram The 'Browse Project' dialog displays. Browse for and select the target Package into which the target diagram will be created, then click on the <i>OK</i> button.
5.	Click on the <i>Do Transform</i> button to execute the transformation. The target diagram is created and listed in the Browser window under the target Package with the name (depending on

	<p>which transformation you have executed):</p> <p><source diagram name> Communication or <source diagram name> Sequence</p>
--	--

Notes

- Once you have selected the 'Communication' or 'Sequence' checkbox, these transforms ignore any other field setting in the dialog except for 'Target Package', and will perform a direct transformation of every element in the source diagram

VB.Net Transformation

The VB.Net transformation converts Platform-Independent Model (PIM) element types to language-specific VB.Net Class element types, and creates encapsulation according to the options you have set for creating properties from VB.Net attributes (on the 'VB.Net Specifications' page of the 'Preferences' dialog). Note that the public attributes in the PIM are converted to private attributes in the PSM.

Example

The PIM elements

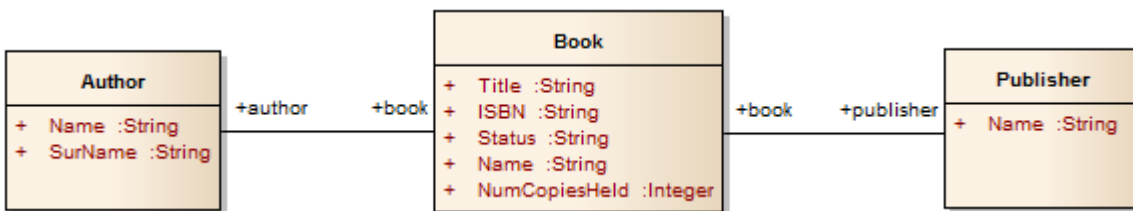

After transformation, become the PSM elements

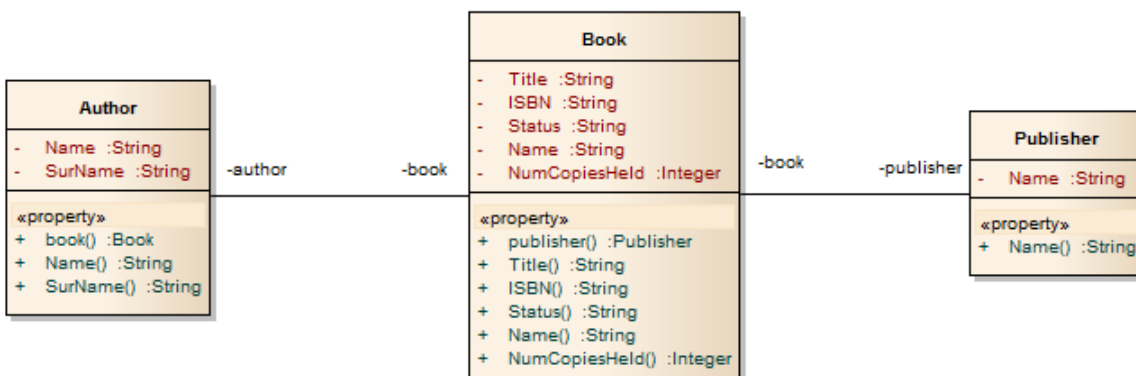

WSDL Transformation

The WSDL transformation converts a simple model into an expanded model of a WSDL interface that is suitable for generation. For example:

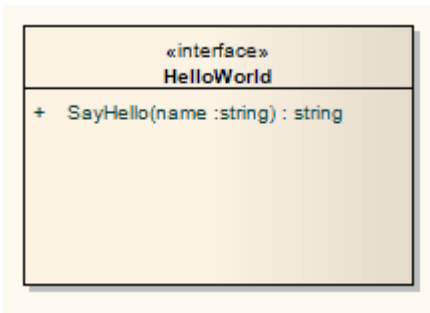

Transformation of this generates the corresponding WSDL Component, Service, Port Type, Binding and Messages:

- Classes are handled in the same way as in the XSD Transformation
- All 'in' parameters are transformed into WSDL Message Parts in the Request message
- The return value and all 'out' and 'return' parameters are transformed into WSDL Message Parts in the Response message
- All methods where a value is returned are transformed into Request-Response operations, and all methods not returning a value are transformed into OneWay operations
- The transformation does not handle the generation of Solicit-Response and Notification methods or faults

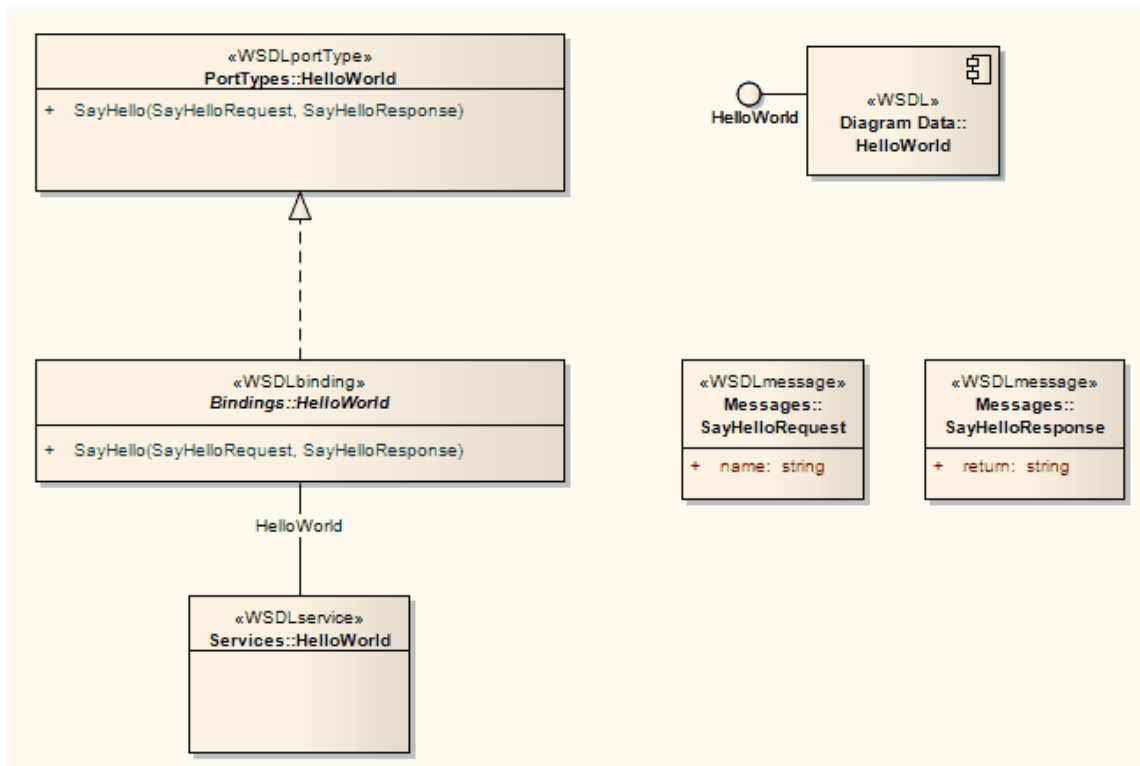

In the resulting Package you can then fill out the specifics using the WSDL editing capabilities of Enterprise Architect, and finally generate the Package using the WSDL generation tools.

XSD Transformation

The XSD transformation converts Platform-Independent Model (PIM) elements to UML Profile for XML elements as an intermediary step in creating an XML Schema. Each selected PIM Class element is converted to an «XSDcomplexType» element.

Example

The PIM elements

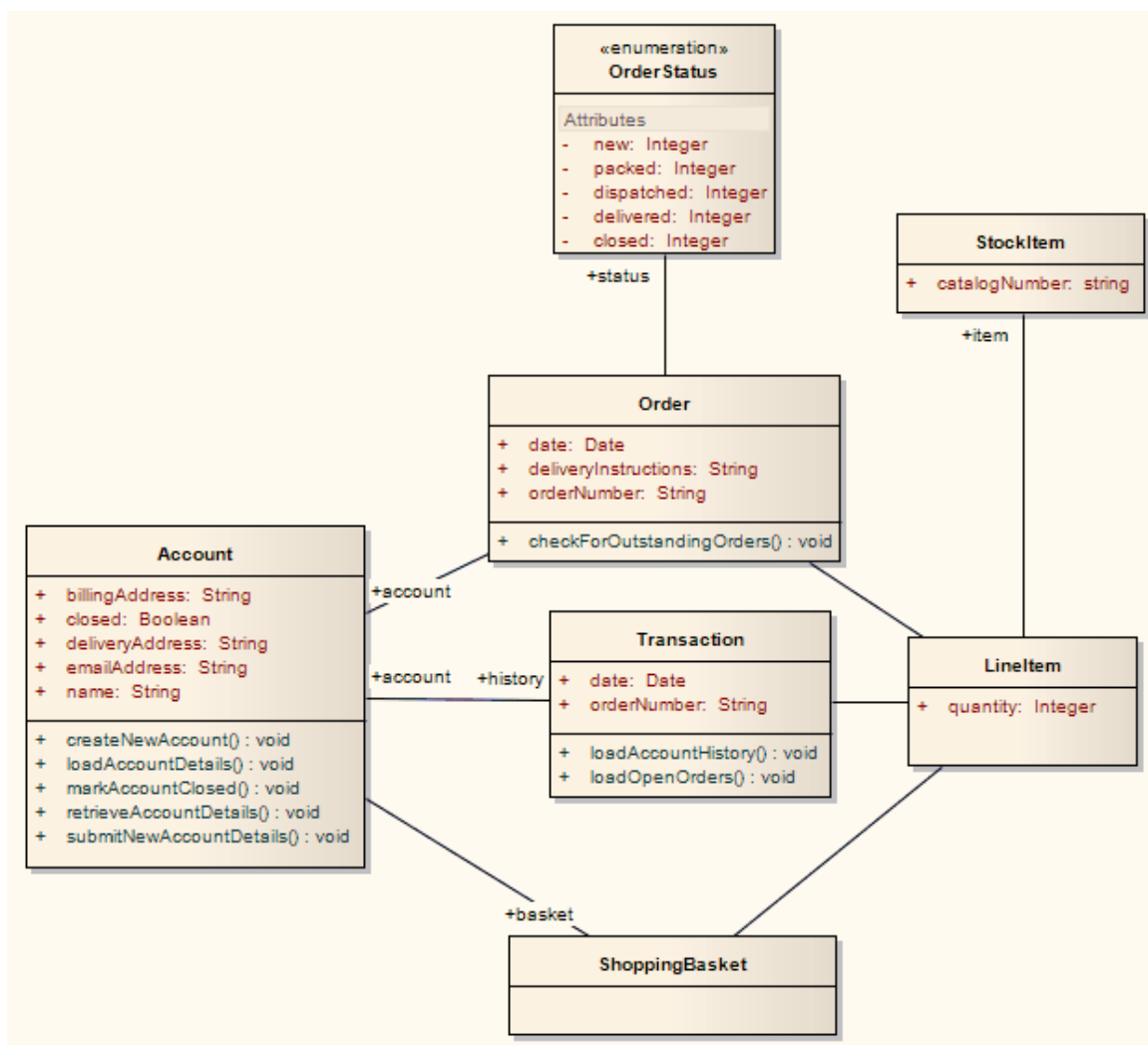

After transformation become the PSM elements

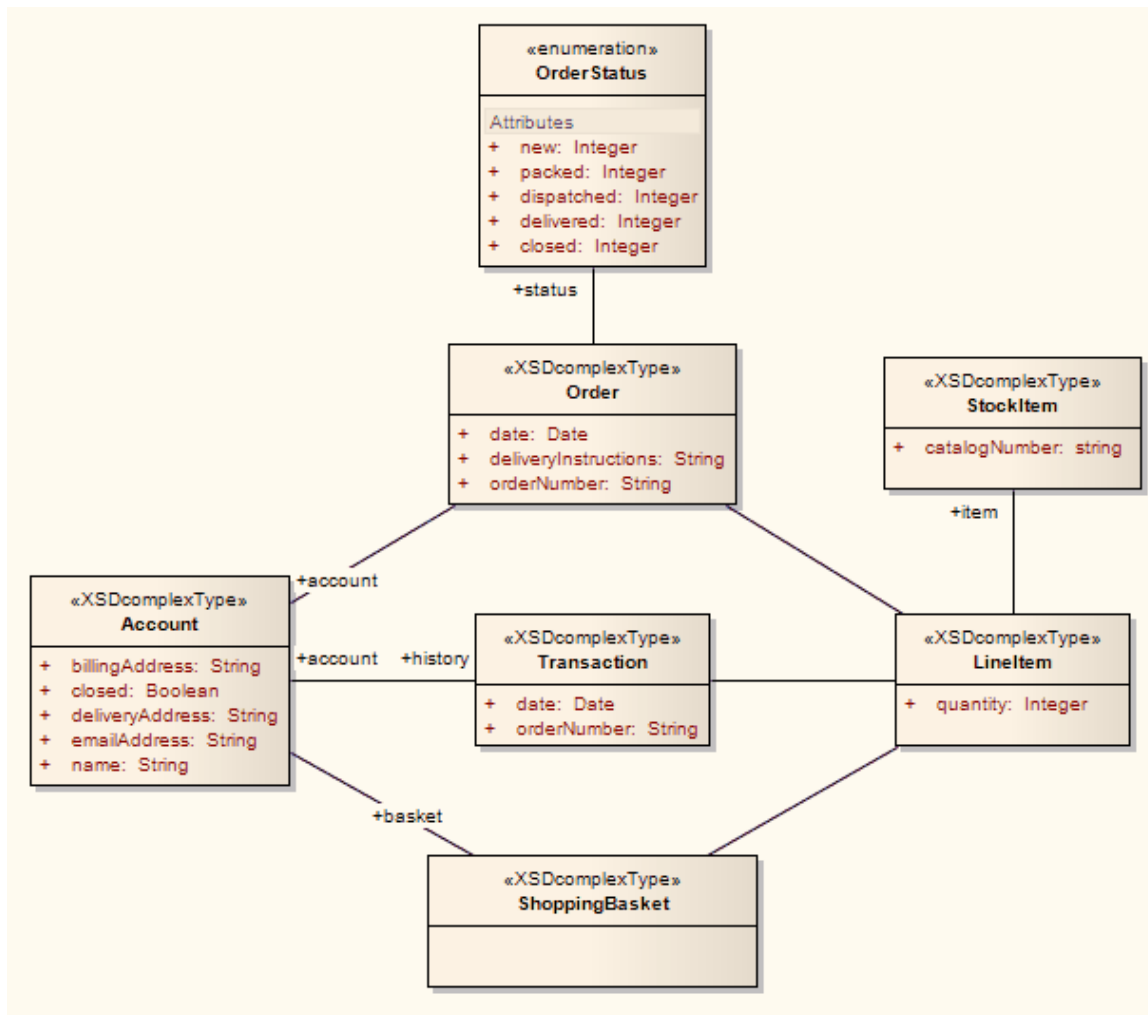

These in turn generate this XSD

```

<?xml version="1.0" encoding="ISO-8859-1"?>
<xs:schema
xmlns:xs="http://www.w3.org/2001/XMLSchema">
<xs:element name="Account" type="Account"/>
<xs:complexType name="Account">
<xs:sequence>
<xs:element name="name" type="xs:string"/>
<xs:element name="billingAddress" type="xs:string"/>
<xs:element name="emailAddress" type="xs:string"/>
<xs:element name="closed" type="xs:boolean"/>
  
```



```
<xs:element name="deliveryAddress" type="xs:string"/>
<xs:element ref="Order"/>
<xs:element ref="ShoppingBasket"/>
</xs:sequence>
</xs:complexType>
<xs:element name="LineItem" type="LineItem"/>
<xs:complexType name="LineItem">
  <xs:sequence>
    <xs:element name="quantity" type="xs:integer"/>
    <xs:element ref="StockItem"/>
  </xs:sequence>
</xs:complexType>
<xs:element name="Order" type="Order"/>
<xs:complexType name="Order">
  <xs:sequence>
    <xs:element name="date" type="xs:date"/>
    <xs:element name="deliveryInstructions" type="xs:string"/>
    <xs:element name="orderNumber" type="xs:string"/>
    <xs:element ref="LineItem"/>
    <xs:element name="status" type="OrderStatus"/>
  </xs:sequence>
</xs:complexType>
<xs:simpleType name="OrderStatus">
  <xs:restriction base="xs:string">
    <xs:enumeration value="new"/>
  </xs:restriction>
</xs:simpleType>

```

```
<xs:enumeration value="packed"/>
<xs:enumeration value="dispatched"/>
<xs:enumeration value="delivered"/>
<xs:enumeration value="closed"/>
</xs:restriction>
</xs:simpleType>
<xs:element name="ShoppingBasket"
type="ShoppingBasket"/>
<xs:complexType name="ShoppingBasket">
<xs:sequence>
<xs:element ref="LineItem"/>
</xs:sequence>
</xs:complexType>
<xs:element name="StockItem" type="StockItem"/>
<xs:complexType name="StockItem">
<xs:sequence>
<xs:element name="catalogNumber" type="xs:string"/>
</xs:sequence>
</xs:complexType>
<xs:element name="Transaction" type="Transaction"/>
<xs:complexType name="Transaction">
<xs:sequence>
<xs:element name="date" type="xs:date"/>
<xs:element name="orderNumber" type="xs:string"/>
<xs:element ref="Account"/>
```

```
<xs:element ref="LineItem"/>  
</xs:sequence>  
</xs:complexType>  
</xs:schema>
```

Edit Transformation Templates

A single transformation applies a number of transformation templates, each of which defines a type of object that is acted on within the transformation, and the actions that are performed on objects of that type. The system provides a range of built-in default templates, and each type of transformation uses a specific subset of these templates. Typically, the transformation type and the subset of templates are tailored to the target language. Some default templates within a set have no content; these are 'latent', and represent the potential for acting on an object that is not generally included in the transformation but is perfectly valid if you wanted to include it. An example of a latent template is the Linked Class Base template in the C# transformation.

You can tailor the transformation templates in various ways, including:

- Adjust the code in one or more of the templates in a default set
- Add code to a 'latent' default template
- Add a new custom template, based on one of the defaults but serving a different purpose that you define
- Add a new transformation type containing - initially - a basic set of default templates
- Add (or remove) a stereotyped override for a template

A stereotyped override directs the transformation to use the modified template only if the element and/or feature are of

the specified stereotyped types. If the object or feature are not of that type, the transformation applies the base template.

Access

Ribbon	Design > Package > Transform > Transform Templates
Keyboard Shortcuts	Ctrl+Alt+H

Edit Transformation Templates

Option	Action
Language	Click on the drop-down arrow and select the name of the transformation.
New Transformation Type	<p>Click on this button if you want to create a new transformation.</p> <p>A prompt displays for the name of the transformation; type in the name and click on the OK button.</p> <p>The 'Templates' list shows the default set</p>

	<p>of built-in templates, from which you can develop your transformation. Your custom transformation is not saved or available for use unless you add and/or edit one or more templates in the transformation.</p>
Templates	<p>Lists the transformation templates for the current transformation.</p> <p>Click on a template name to highlight it and display its content in the Template panel. The 'Modified' column indicates whether you have edited the template for this transformation.</p>
Template	<p>Displays the contents of the currently-selected template, and provides the editor facilities for modifying the template (right-click on the code text).</p>
Stereotype Overrides	<p>Lists the stereotyped templates, for the active base template.</p> <p>The 'Modified' column indicates whether you have modified a stereotyped template.</p>
Add New Custom Template	<p>Click on this button to create a custom template to add to the current transformation.</p>

	<p>A dialog displays, prompting you to specify:</p> <ul style="list-style-type: none"> • The object type (base template type) that this new template will respond to - click on the drop-down arrow and select the name (custom template types are not included in this list) • The name of the new template - type in the appropriate text <p>Click on the OK button. The new template name is added to the list of templates, and it is opened in the template editor ready for you to add its code.</p>
<p>Add New Stereotyped Override</p>	<p>Click on this button to add a new stereotype override for the currently selected template. A dialog displays, prompting you to specify the:</p> <ul style="list-style-type: none"> • Base Class (stereotyped Class type - click on the drop-down arrow and click on the type in the list) and/or • Feature (click on the drop-down arrow and click on the stereotyped feature in the list) <p>Click on the OK button. The override is added to the 'Stereotype Overrides' list.</p>
<p>Get Default</p>	<p>Click on this button to update the editor display with the default version of the</p>

Template	<p>current built-in template or to clear the content of the current custom template. If you have saved the changed template, re-instating the default version is a change, so the 'Modified' field still displays the word 'Yes'.</p>
Save	<p>Click on this button to save the new or edited current template. You cannot switch to another template without saving the current template, so this effectively saves the transition as well.</p>
Delete	<p>Click on this button to delete the current custom template or stereotype override, or the most recent changes to a built-in template (effectively returning it to the default, base content). You cannot delete a built-in template.</p> <p>You are prompted to confirm the deletion.</p>
Help	<p>Click on this button to display this Help topic.</p>

Notes

- Transformation template editing is based very strongly on code generation template editing; for additional information on editing transformation templates see the *Code Template Editor* section and the *Editing Source Code* topic

Write Transformations

Enterprise Architect provides a facility to create your own transformations; this can be useful to automate the process of generating more specific models from more general ones, reusing the transformation and preventing errors from being introduced as they might if the models were created by hand. The existing templates will provide a useful guide and reference to assist you when creating new templates.

Transformation templates are based on the Code Generation Template Framework, and an understanding of the way these templates work is critical to be able to adjust existing transformation templates or to create new ones. Therefore it is suggested that you read and understand the topics discussing Code Generation Templates prior to using the Transformation Template language.

Access

Ribbon	Design > Package > Transform > Transform Templates
Keyboard Shortcuts	Ctrl+Alt+H

Factors concerning Transformation

Templates

Factor	Detail
Default Transformation Templates	Enterprise Architect provides a set of default transformation templates that you can use 'as is' or customize to your requirements.
General Syntax for the Intermediary Language	Transformations in Enterprise Architect generate an intermediary code form of the model being created in the transformation. You can review and edit this code.
Intermediary Language Debugging	You can also debug transformation scripts by checking the intermediary code generated from the Transform script.
Editing transformation templates and code	When writing transformations, you use the facilities of the common Code Editor.
Code Template Framework	You use the Code Template Framework to perform forward engineering of UML models. The Transformation Template Framework is derived from this.

Syntax for Creating Objects	To generate objects or elements in a transformation, you apply a specific syntax in the template script.
Syntax for Creating Connectors	To generate connectors (relationships) in a transformation, you also apply a specific syntax in the template script.
Transforming Duplicate Information	In many transformations there is a substantial amount of information to be copied. Rather than place this information in the template, you can use macros to read it from its source.
Transforming Template Parameter Substitutions	In a transformation template, if you are transforming Template Binding connector binding parameter substitutions, you can use the Template Parameter substitution macros.
Converting Types	You can apply various methods for converting data types to different target platform types.
Converting Names	You can apply various methods for converting names of elements to different target platform naming conventions.

Cross References	During a transformation, you can perform cross verification of transformed elements.
------------------	--

Notes

- Further hints and tips can be gleaned from a close study of the Transformation Templates provided with Enterprise Architect
- The Transformation Template editor applies the facilities of the common Code Editor

Default Transformation Templates

Transformation templates provide the ability to represent the existing information in a model in a modified way. When creating a new transformation Enterprise Architect provides a default set of transformation templates that perform a direct copy of the source model to the target model. This allows you to think in terms of how the source model and target model are different. For each template you are able to prevent properties from being copied and add additional information until the appropriate target model is created.

You can list and examine the default templates in the Transformation Editor. The combination of default templates varies according to the language you are transforming.

Access

Ribbon	Design > Package > Transform > Transform Templates
Keyboard Shortcuts	Ctrl+Alt+H

Notes

- When creating a new transformation you must modify at least one template before the new transformation becomes available

Intermediary Language

All transformations in Enterprise Architect create an intermediary language form of the model to generate. You can access and edit the file containing this intermediary language code using an external editor. Each object is represented in this language by the object type (for example, Class, Action, Method, Generalization or Tag) followed by the object properties and the features that it is made from; the grammar of the object description resembles this:

element:

```
elementName { (elementProperty | element)* }
```

elementProperty:

```
packageName
```

```
stereotype
```

```
propertyName = " propertyValueSymbol* "
```

packageName:

```
name = " propertyValueSymbol* " ( . "
```

```
propertyValueSymbol* ")*
```

stereotype:

```
stereotype = " propertyValueSymbol* " ( , "
```

```
propertyValueSymbol* ")*
```

propertyValueSymbol:

```
\\
```

```
\"
```

```
Any character except " (U+0022), \ (U+005C)
```

- `elementName` is any one of the set of element types
- `propertyName` is any one of the set of properties

Literal strings can be included in property values by 'escaping' a quote character:

```
default = "\"Some string value.\""
```

Intermediary Language Debugging

The script from an MDA template produces intermediate language text. However, on generating the model this script could return errors. When an error occurs, you can view and debug the generated text externally, preferably in an editor that prompts on updates to the file alterations.

Access

Ribbon	Design > Package > Transform > Transform Selection
Keyboard Shortcuts	Ctrl+H (transform selected elements) Ctrl+Shift+H (transform current Package)

Debug when errors are returned on generating altered code

Step	Description
1	Select the Package to be transformed, and the

	<p>'Transform Package' option.</p> <p>The 'Model Transformations' dialog displays.</p>
2	<p>In the 'Name' column, select the checkbox against the type of transformation being altered.</p>
3	<p>In the 'Intermediary File' field, click on the <input type="text" value="..."/> button and set the file location into which to generate the code.</p>
4	<p>Select the 'Write Always' checkbox, and click on the Write Now button to generate the script.</p> <p>This only generates the script, not the model.</p>
5	<p>If an error is returned specifying the line number of the problem, open the file in an external Code Editor (with Line Numbering) and locate the line number of problem.</p>
6	<p>Alter the template code to correct the error.</p>
7	<p>Click on the Do Transform button to check that the alteration has corrected the problem.</p>

Example

For a MySQL database, the template code might resemble

this:

```
$enumFieldName = "test"
```

```
Column
```

```
{  
name= %qt%% CONVERT_NAME ($enumFieldName,  
"Pascal Case", "Camel Case")%qt%  
type= %qt%% CONVERT_TYPE (genOptDefaultDatabase,  
"Enum")%qt%  
}
```

This returns the output in the generated text file as:

```
Column
```

```
{  
name = "test"  
type = "ENUM"  
}
```

If there is an error in the original transform, such as a spelling error - ‘Colum’ - clicking the Do Transform button returns an error message referring to the first line of intermediate code that includes the error 'Colum’.

Objects

Objects are generated in a transformation as text in this form:

```
objectType
{
    objectProperties*
    XRef{xref}*
    Tag{tag}*
    Attribute{attributes}*
    Operation{operations}*
    Classifier{classifiers}*
    Parameter{parameters}*
}
```

For example:

```
Class
{
    name = "Example"
    language = "C++"
    Tag
    {
        name = "defaultCollectionClass"
        value = "List"
    }
}
```

```
Attribute
{
    name = "count"
    type = "int"
}
}
```

Every object created in a transformation should include an XRef syntax element (see the end of this topic), as it helps the system to synchronize with the object and makes it possible to create a connector to that Class in the transformation.

Syntax elements in the code

Element	Detail
objectType	objectType is one of these: <ul style="list-style-type: none">• Action• ActionPin• Activity• ActivityParameter• ActivityPartition• ActivityRegion• Actor• Association

- Change
- Class
- Collaboration
- CollaborationUse
- Component
- DeploymentSpecification
- DiagramFrame
- Decision
- EntryPoint
- Event
- ExceptionHandler
- ExecutionEnvironment
- ExitPoint
- ExpansionNode
- ExpansionRegion
- ExposedInterface
- GUIElement
- InteractionFragment
- InteractionOccurrence
- InteractionState
- Interface
- InterruptibleActivityRegion
- Issue
- Iteration
- Object

	<ul style="list-style-type: none"> • ObjectNode • MergeNode • MessageEndpoint • Node • Package • Parameter • Part • Port • ProvidedInterface • RequiredInterface • Requirement • Sequence • State • StateMachine • StateNode • Synchronization • Table • TimeLine • Trigger • UMLDiagram • UseCase
objectProperties	<p>objectProperties is zero, or one instance of one or more of these:</p> <ul style="list-style-type: none"> • Abstract • Alias

- Arguments
- Author
- Cardinality
- Classifier
- Complexity
- Concurrency
- Filename
- Header
- Import
- IsActive
- IsLeaf
- IsRoot
- IsSpecification
- Keyword
- Language
- Multiplicity
- Name
- Notes
- ntype
- Persistence
- Phase
- Scope
- Status
- Stereotype
- Version

	<ul style="list-style-type: none">• Visibility
Attribute	<p>Attribute has the same structure as <code>objectType</code>, and includes these properties:</p> <ul style="list-style-type: none">• Alias• Classifier• Collection• Container• Containment• Constant• Default• Derived• LowerBound• Name• Notes• Ordered• Scope• Static• Stereotype• Type• UpperBound• Volatile <p>Attribute also includes these elements:</p> <ul style="list-style-type: none">• Classifier

	<ul style="list-style-type: none">• Tag• XRef
Operation	<p>Operation has the same structure as <code>objectType</code>, and includes these properties:</p> <ul style="list-style-type: none">• Abstract• Alias• Behavior• Classifier• Code• Constant• IsQuery• Name• Notes• Pure• ReturnArray• Scope• Static• Stereotype• Type <p>Operation also includes these elements:</p> <ul style="list-style-type: none">• Classifier• Parameter• Tag

	<ul style="list-style-type: none"> • XRef
Parameter	<p>Parameter has the same structure as objectType, and includes the Tag element and these properties:</p> <ul style="list-style-type: none"> • Classifier • Default • Fixed • Name • Notes • Kind • Stereotype
Tag	<p>Tag has these properties:</p> <ul style="list-style-type: none"> • Name • Value

Special Cases

Certain types of object have variations of the object definition syntax.

Object	Detail
Packages	<p>Packages differ from other objects in these ways:</p> <ul style="list-style-type: none"> • They have a reduced set of properties:

	<p>alias, author, name, namespaceRoot, notes, scope, stereotype and version</p> <ul style="list-style-type: none"> • The property namespaceRoot is only given to Packages • A name must be specified for each Package • The name property can be a qualified name; when a qualified name is specified, the properties given are applied only to the final Package • Only Packages can contain other Packages • Packages cannot contain attributes and operations
XRef	<p>Cross references are defined using the transform statements. The properties include:</p> <ul style="list-style-type: none"> • Namespace • Name • Source • Notes
Tables	<p>Tables are a special type of object, with these differences from other object types:</p> <ul style="list-style-type: none"> • They can include columns and primary keys

	<ul style="list-style-type: none">• They cannot include attributes
Columns	<p>Columns are similar to attributes, but have an autonumber element containing Startnum and its increment, and these added properties:</p> <ul style="list-style-type: none">• Length• NotNull• Precision• PrimaryKey• Scale• Unique <p>In the column definition, you cannot assign a value to the NotNull, PrimaryKey or Unique properties.</p>

Connectors

The process of creating connectors in a transformation has the same form as for creating elements (objects). It is a little more complex, because you also define each end of the connector - the source and target.

Connectors are represented in the Intermediary language as:

```
ConnectorType
{
    connectorProperties*
    AssociationClass {associationClassProperties*}
    Source {sourceProperties*}
    Target {targetProperties*}
}
```

For example:

```
Association
{
    name="anAssociation"
    stereotype=""
    direction="Unspecified"
    Source
    {
        access="Private"
        navigability="Unspecified"
    }
}
```

```
    }  
    Target  
    {  
        access="Private"  
        multiplicity="1..*"  
    }  
}
```

Syntax elements in the code

Element	Detail
ConnectorType	ConnectorType is one of these: <ul style="list-style-type: none">• Abstraction• Aggregation• Assembly• Association• Collaboration• ControlFlow• Connector• Delegate• Dependency• Deployment• ForeignKey• Generalization

	<ul style="list-style-type: none">• InformationFlow• Instantiation• Interface• InterruptFlow• Manifest• Nesting• NoteLink• ObjectFlow• Package• Realization• Sequence• Substitution• TemplateBinding• Transition• Usage• UseCase• Uses
connectorProperties	<p>connectorProperties is zero, or one instance of one or more of these:</p> <ul style="list-style-type: none">• alias• direction• notes• name• stereotype• tag

	<ul style="list-style-type: none"> • XRef
associationClassProperties	<p>associationClassProperties are one instance of these:</p> <ul style="list-style-type: none"> • Classifier • XRef
sourceProperties targetProperties	<p>sourceProperties and targetProperties are each a reference to an element and zero, or one instance of one or more of these:</p> <ul style="list-style-type: none"> • aggregation • alias • allowduplicates • changeable • constraint • containment • navigability • membertype • multiplicity • Notes • ordered • qualifier • role • scope • stereotype • tag

Element Reference	<p>An element reference is either a guid that references an element that already exists before the transformation, or an XRef to reference an element that is created by a transformation.</p> <ul style="list-style-type: none">• guid• XRef
-------------------	--

Notes

- Each connector is transformed at both end objects, therefore the connector might appear twice in the transformation; this is not a problem, although you should check carefully that the connector is generated exactly the same way, regardless of which end is on the current Class

Transform Connectors

When you transform a connector, you can use two different types of Class as the connector ends: either a Class created by a transformation, or an existing Class for which you already know the GUID.

Connect to a Class Created by a Transformation

The most common connection is to a Class created by a transformation; to create this connection you use three items of information:

- The original Class GUID
- The name of the transformation
- The name of the transformed Class

This type of connector is created using the `TRANSFORM_REFERENCE` function macro; when the element is in the current transformation, it can be safely omitted from the transformation. The simplest example of this is when you have created multiple Classes from a single Class in a transformation, and you want a connector between them; consider this script from the EJB Entity transformation:

Dependency

```
{  
%TRANSFORM_REFERENCE("EJBRealizeHome",classGUID)% stereotype="EJBRealizeHome"
```

Source

```
{  
%TRANSFORM_REFERENCE("EJBEntityBean",classGUID)%  
}
```

Target

```
{  
%TRANSFORM_REFERENCE("EJBHomeInterface",classGUID)%  
}  
}
```

In this script there are three uses of the `TRANSFORM_REFERENCE` macro: one to identify the connector for synchronization purposes and the other two to identify the ends; all three use the same source GUID, because they all come from the one original Class. None of the three have to specify the transformation because the two references are to something within the current transformation - each of them then only has to identify the transform name.

It is also possible to create a connector from another connector. You can create a connector template and list all connectors connected to a Class from the Class level templates; you don't have to worry about only generating the connector once, because if you have created a `TRANSFORM_REFERENCE` for the connector then the system automatically synchronizes them.

This script copies the source connector:

```
%connectorType%
{
%TRANSFORM_CURRENT()%
%TRANSFORM_REFERENCE("Connector",connectorGUID)%
Source
{
%TRANSFORM_REFERENCE("Class",connectorSourceGUID)%
%TRANSFORM_CURRENT("Source")%
}
Target
{
%TRANSFORM_REFERENCE("Class",connectorDestGUID)%
%TRANSFORM_CURRENT("Target")%
}
}
```

Connecting to a Class for which you know the GUID

The second type of Class that you can use as a connector end is an existing element for which you know the current GUID. To create this connection, specify the GUID of the

target Class in either the source or target end; this script creates a Dependency from a Class created in a transformation, to the Class it was transformed from:

Dependency

```
{
%TRANSFORM_REFERENCE("SourceDependency",class
GUID)%
stereotype="transformedFrom"
```

Source

```
{
%TRANSFORM_REFERENCE("Class",classGUID)%
}
```

Target

```
{
GUID=%qt%%classGUID%%qt%
}
}
```

Notes

- Each connector is transformed at both end objects, therefore the connector might appear twice in the transformation; this is not a problem, although you should check carefully that the connector is generated exactly the same way, regardless of which end is on the current Class

Transform Foreign Keys

Enterprise Architect supports the transformation into Foreign Keys of many different types of relationship defined between entities in a logical model.

Each Foreign Key in a Physical model is represented by the combination of a stereotyped connector and an operation in each of the involved Tables. Foreign Key transformations are achieved with the 'Connector' template in the DDL language. This template generates an intermediate dataset that is then interpreted by Enterprise Architect's transformation engine to create all the required physical entities and connectors.

By default, Enterprise Architect supports transformations of these connector types:

- Generalization - this kind of connector will create a Foreign Key with a multiplicity of 0..1 in the source and 1 in the destination
- Association Class - this kind of connector will create a 'join' table linking both the source and destination Tables
- Association/Aggregation - these kinds of connector use the multiplicity defined in the Logical model's relationship to join the source and destination Tables

All Foreign Key definitions will cause the addition of a new integer (or equivalent) column in both source and destination Tables, which will act as the Primary Key in the source Table and the Foreign Key column in the destination Table. The default names for the new columns will be the

Table name with the suffix of 'ID' added, whilst the names of the Foreign Keys will be automatically generated using the FK DDL template.

Copy Information

In many transformations there is a substantial amount of information to be copied.

It would be tedious to type all of the common information into a template so that it is copied to the transformed Class; the alternative is to use the `TRANSFORM_CURRENT` and `TRANSFORM_TAGS` function macros.

Use of Macros

Objective	Detail
Copy Object	<p><code>TRANSFORM_CURRENT</code> (<code><listOfExcludedItems></code>)</p> <p>The function generates an exact copy of all the properties of the current item, except for the items named in <code><listOfExcludedItems></code>.</p>
Copy Connector	<p>Another form of the function is available when transforming connectors to copy either end of the connector:</p> <p><code>TRANSFORM_CURRENT</code> (<code><connectorEnd></code>, <code><listOfExcludedItems></code>)</p>

	<p>This generates an exact copy of the connector end specified by <code><connectorEnd></code> (either Source or Target) except for the items named in <code><listOfExcludedItems></code>.</p>
Copy Tags	<p><code>TRANSFORM_TAGS</code> (<code><listOfExcludedItems></code>)</p> <p>The function generates an exact copy of all the Tagged Values of the current item, except for the items named in <code><listOfExcludedItems></code>.</p>

Convert Types

Different target platforms almost certainly require different data types, so you usually require a method of converting between types. This is offered by the macro:

`CONVERT_TYPE (<destinationLanguage>, <originalType>)`

This function converts `<originalType>` to the corresponding type in `<destinationLanguage>` using the datatypes and common types defined in the model, where `<originalType>` is assumed to be a platform independent common type.

A similar macro is available when transforming common datatypes to the datatypes for a specified database:

`CONVERT_DB_TYPE (<destinationDatabase>, <originalType>)`

This function converts `<originalType>` to the corresponding datatypes in `<destinationDatabase>`, which is defined in the model; `<originalType>` refers to a platform independent common datatype.

Convert Names

Different target platforms use different naming conventions, so you might not want to copy the names of your elements directly into the transformed models. To facilitate this requirement, the transformation templates provide a `CONVERT_NAME` function macro.

Another way in which you can transform a name is to remove a prefix from the original name, with the `REMOVE_PREFIX` macro.

`CONVERT_NAME (<originalName>, <originalFormat>, <targetFormat>)`

This macro converts `<originalName>`, which is assumed to be in `<originalFormat>`, to `<targetFormat>`.

The supported formats are:

- **Camel Case:** the first word begins with a lower-case letter but subsequent words start with an upper-case letter; for example, `myVariableTable`
- **Pascal Case:** the first letter of each word is upper case; for example, `MyVariableTable`
- **Spaced:** words are separated by spaces; the case of letters is ignored
- **Underscored:** words are separated by underscores; the case of letters is ignored

The original format might also specify a list of delimiters to be used. For example a value of `'_'` breaks words whenever

either a space or underscore is found. The target format might also use a format string that specifies the case for each word and a delimiter between them. It takes this form:

<firstWord> (<delimiter>) <otherWords>

- <firstWord> controls the case of the first word
- <delimiter> is the string generated between words
- <otherWords> applies to all words after the first word

Both <firstWord> and <otherWords> are a sequence of two characters. The first character represents the case of the first letter of that word, and the second character represents the case of all subsequent letters. An upper case letter forces the output to upper case, a lower case letter forces the output to lower case, and any other character preserves the original case.

Example 1: To capitalize the first letter of each word and separate multiple words with a space:

"Ht()Ht" to output "My Variable Table"

Example 2: To generate the equivalent of Camel Case, but reverse the roles of upper and lower case; that is, all characters are upper case except for the first character of each word after the first word:

"HT()hT" to output "MY vARIABLE tABLE"

**REMOVE_PREFIX(<originalName>,
<prefixes>)**

This macro removes any prefix found in <prefixes> from

<originalName>. The prefixes are specified in a semi-colon separated list.

The macro is often used in conjunction with the CONVERT_NAME macro. For example, this code creates a get property name according to the options for Java:

```
$propertyName=%REMOVE_PREFIX(attName,genOptPropertyPrefix)%  
  %if genOptGenCapitalisedProperties=="T"%  
    $propertyName=%CONVERT_NAME($propertyName,  
"camel case", "pascal case")%  
  %endif%
```

Notes

- Acronyms are not supported when converting from Camel Case or Pascal Case

Cross References

Cross References are an important part of transformations. You can use them to:

- Find the transformed Class to synchronize with
- Create connectors between transformed Classes
- Specify a classifier of a type
- Determine where to transform to for future transformations

Each Cross Reference has three different parts:

- A Namespace, corresponding to the transformation that generated the element
- A Name, which is a unique reference to something that can be generated in the transformation, and
- A Source, which is the GUID of the element that this element was created from

When writing the templates for a transformation it is easiest to generate the Cross References using the macro defined for this purpose:

```
TRANSFORM_REFERENCE (<name>, <sourceGuid>, <namespace>)
```

The three parameters are optional. The macro generates a reference that resembles this:

```
XRef{namespace="<namespace>" name="<name>" source="<sourceGuid>"
```

- If <name> is not specified the macro gets the name of the

current template

- If <sourceGUID> is not specified the macro gets the GUID of the current Class
- If <namespace> is not specified the macro gets the name of the current transformation

The only time that a Cross Reference should be specified is when creating a connector to a Class created in a different transformation.

A good example of the use of Cross References is in the DDL transformation provided with Enterprise Architect. In the Class template a Cross Reference is created with the name 'Table'. Then up to two different connectors can be created, each of which must identify the two Classes it connects using Cross References, while having its own unique Cross Reference.

Specify Classifiers

Objects, attributes, operations and parameters can all reference another element in the model as their type. When this type is created from a transformation you must use a cross reference to specify it, using the macro:

```
TRANSFORM_CLASSIFIER (<name>, <sourceGuid>, <namespace>)
```

This macro generates a cross reference within a classifier element, where the parameters are identical to the TRANSFORM_REFERENCE macro but the name Classifier is generated instead of XRef.

If the target classifier already exists in the model before the transformation, `TRANSFORM_CLASSIFIER` is inappropriate, so instead the `GUID` can be given directly to a classifier attribute.

If a classifier is specified for any type, it overrides that type.

Transform Template Parameter Substitution

If you want to provide access in a transformation template to data concerning the transformation of a Template Binding connector's binding parameter substitution in the model, you can use the Template Parameter substitution macros.

Factors in the Transformation

Factor	Detail
Intermediary Language	<p>Template Parameter Substitutions are represented in the Intermediary language as:</p> <pre> TemplateParameterSubstitution { Formal { FormalProperties } Actual { ActualProperties } } </pre> <p>For example:</p> <pre> TemplateParameterSubstitution { Formal { </pre>

	<pre> name=%qt%%parameterSubstitutionFor mal%%qt% } Actual { name=%qt%%parameterSubstitutionActu al%%qt% %TRANSFORM_CLASSIFIER("Class", parameterSubstitutionActualClassifier)% } } </pre>
<p>Formal Properties or Actual Properties</p>	<p>FormalProperties and ActualProperties are zero, or one instance of one of these properties:</p> <ul style="list-style-type: none"> • name • classifier
<p>Transform of Parameter Substitution Actual parameter</p>	<p>If the Actual parameter is assigned a String Expression, it will transform as Actual name. You can assign the Actual Classifier if you know the GUID:</p> <pre> TemplateParameterSubstitution (Formal </pre>

```

{
name=%qt%%parameterSubstitutionFor
mal%%qt%
}
Actual
{
name=%qt%%parameterSubstitutionActu
al%%qt%
classifier=%qt%%parameterSubstitution
ActualClassifier%%qt%
}
}

```

If you want the Actual parameter to be transformed so that its Classifier is assigned with an element that is transformed, then use `TRANSFORM_CLASSIFIER` or `TRANSFORM_REFERENCE`, as shown:

TemplateParameterSubstitution

```

{
Formal
{
name=%qt%%parameterSubstitutionFor
mal%%qt%
}
}

```

Actual

```
{  
name=%qt%%parameterSubstitutionActual%%qt%  
%TRANSFORM_CLASSIFIER("Class",  
parameterSubstitutionActualClassifier)%  
}  
}
```

Or

TemplateParameterSubstitution

```
{  
Formal  
{  
name=%qt%%parameterSubstitutionFormal%%qt%  
}  
}
```

Actual

```
{  
name=%qt%%parameterSubstitutionActual%%qt%  
%TRANSFORM_REFERENCE("Class",  
parameterSubstitutionActualClassifier)%  
}  
}
```



Bookmarks

A bookmark is a visual cue to to the modeler, to monitor or pay particular attention to an Element. Bookmarks can be attributed any meaning you wish, so they can be used for a variety of purposes to highlight particular aspects of your model.

There are two type of bookmarks:

- Standard
- Annotated

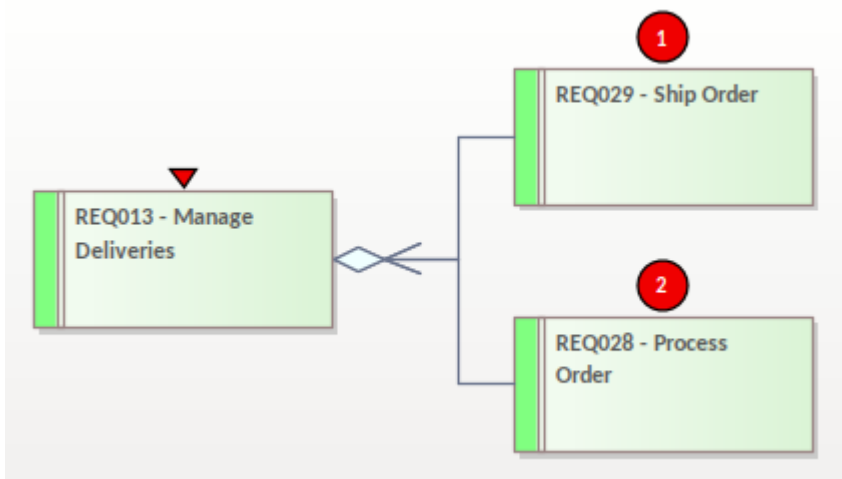
In this example the Element on the left has a standard bookmark and the Elements on the right have annotated bookmarks.



Bookmark Types

Option	Action
Standard	A Standard Bookmark is represented by a small red triangle (or red Del symbol)

Bookmarks	that displays above the element in the diagram or Model Search. It includes features for bookmarking elements based on their maintenance item status and their test case status.
Annotated Bookmarks	The Annotated Bookmarks can be defined with a numerical or text value that is displayed in the bookmark in a diagram. The diagram view of these can be enabled or disabled for that diagram.

Standard Bookmarks

Standard Bookmarks can be used to clearly highlight specific Elements in a diagram and can be quickly applied with a single keystroke (Shift+Space). Using the standard bookmarks you can bookmark:

- Single elements manually, or
- All elements in a Package automatically when they assume a defined status

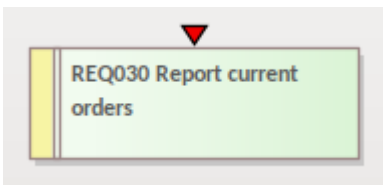

Bookmark Options

Option	Action
Bookmark a selected element in a diagram	Either: <ul style="list-style-type: none"> • Press Shift+Space, or • Select the 'Design > Element > Manage > Bookmark' ribbon option
Clear a bookmark on a selected element	Use either of the two options again.

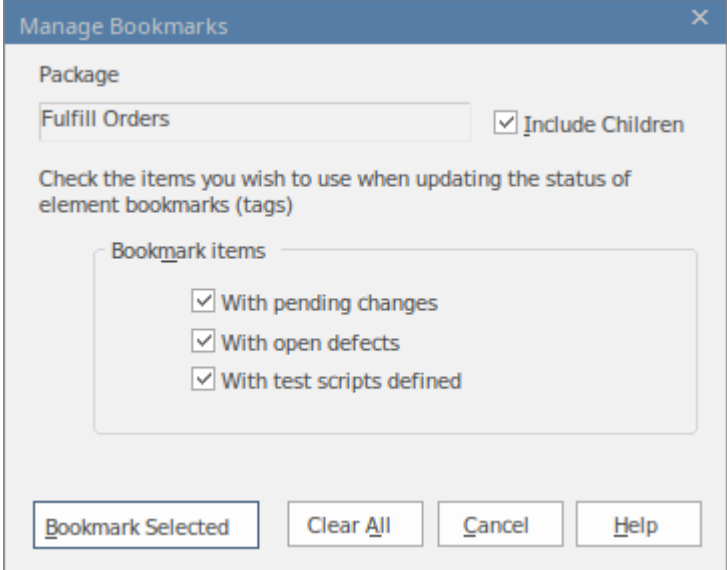
<p>Bookmark Multiple Elements in a Package</p>	<p>Browser window Right-click on Package Contents Bookmarks</p> <p>The 'Manage Bookmarks' dialog displays, which you can use to automatically bookmark any elements (and, if required, their children) in the Package that have:</p> <ul style="list-style-type: none"> • New changes defined in the Maintenance window • New defects defined in the Maintenance window, and/or • Test scripts defined in the Test Cases window <p>This is useful to highlight elements that have additional project information.</p> 
<p>Clear all elements of bookmarks</p>	<p>To clear all bookmarks:</p> <ul style="list-style-type: none"> • Throughout the current Package, click on the Clear All button on the 'Manage Bookmarks' dialog

- | | |
|--|---|
| | <ul style="list-style-type: none">• In the current diagram, select the bookmarked elements (or Ctrl+A for all elements) and then press Shift+Space. |
|--|---|

Notes

- You should reload the project to update it with the new or cleared bookmarks
- The Find in Project window provides the facility to search based on Standard Bookmarked elements.

Annotated Bookmarks

Annotated Bookmarks can be used to clearly highlight specific Elements in a diagram with a marker showing simple text or numbers. Annotated Bookmarks provide a means of identifying Elements that need to be brought to the foreground when displaying a model or for highlighting Elements that require further work.



Bookmark Options

Option	Description
Bookmark a selected element in a diagram	To set an annotated Bookmark: <ul style="list-style-type: none">• Select an Element• Select 'Set Bookmark Value' from the context menu• Tick the 'Enable Bookmark' checkbox• Type in a numerical or text value for the bookmark• Click on the OK button.

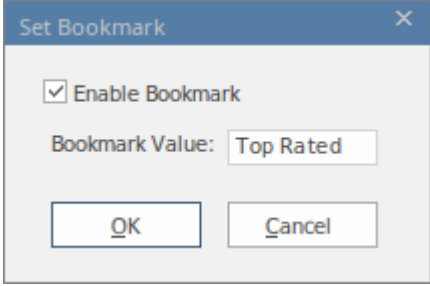
	
<p>Clear a bookmark on a selected element</p>	<p>To clear an annotated Bookmark:</p> <ul style="list-style-type: none">• Select an Element• Select 'Set Bookmark Value' from the context menu• Un-tick the 'Enable Bookmark' checkbox• Click on the OK button.
<p>Hide/Show Annotated Bookmarks in a Diagram</p>	<p>You can hide or show all bookmarks on a diagram using the 'Hide All Bookmark Values' or 'Show all Bookmark Values' options on the Diagram Context menu.</p>

